



МЕТАЛЛОПРОДУКЦИЯ

Наименование продукта:
Фаркоп несъемный

Номер детали:
10.3662.12/11.3662.12

Инструкция по установке





МЕТАЛЛОПРОДУКЦИЈА

Номер детали:

10.3662.12/11.3662.12

Модель автомобиля: Kia Sportage	Год выпуска автомобиля: 2016-
Допустимая полная масса прицепа: 2500 kg	Вертикальная нагрузка на шар: 100 kg
Вес нетто: 18,32 kg	

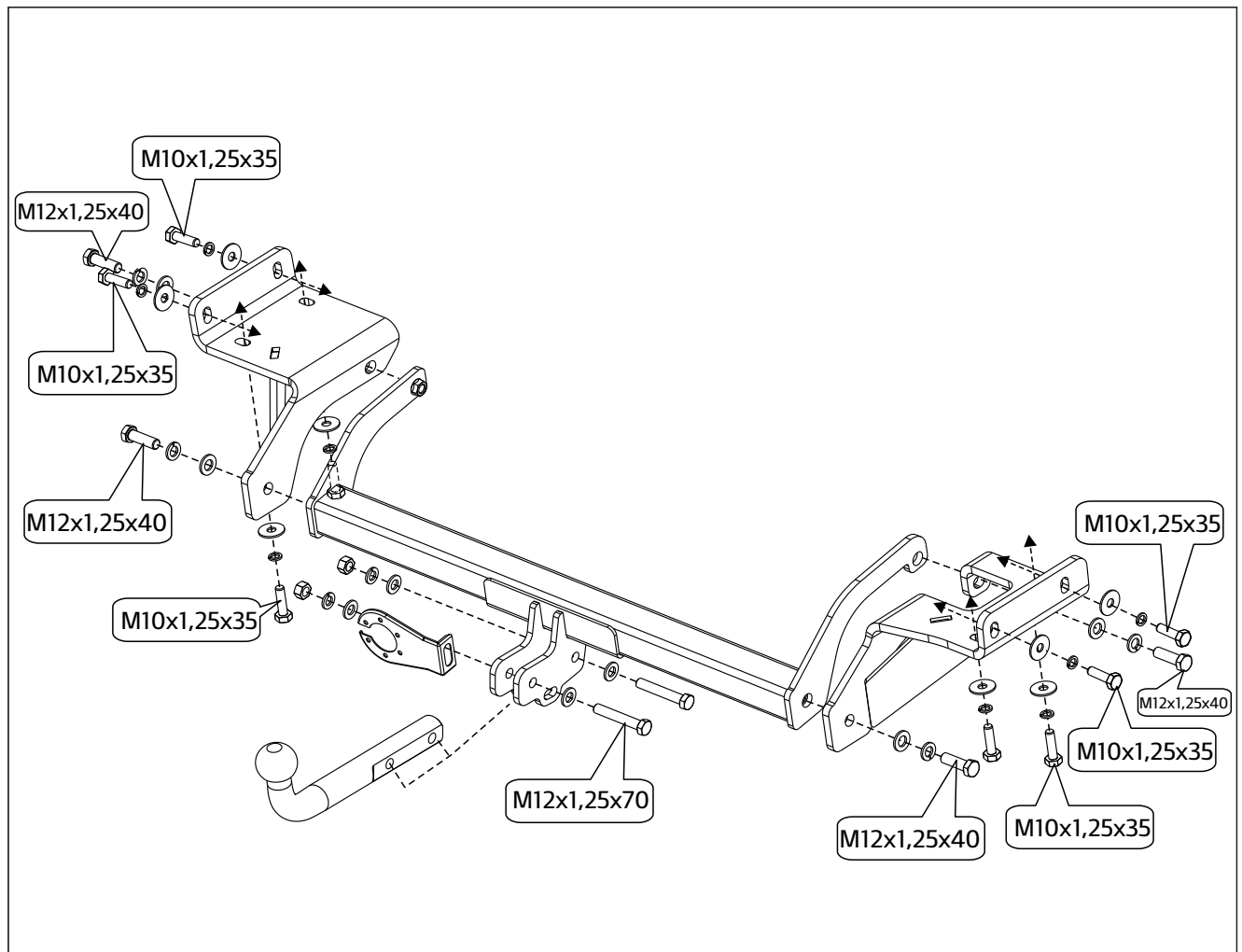



Номер детали: 10.3662.12/11.3662.12			Страница 02
--	--	--	----------------



МЕТАЛЛОПРОДУКЦИЈА

Номер детали:

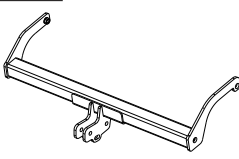
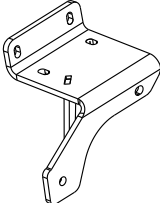
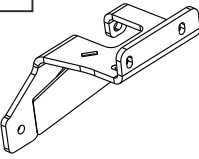
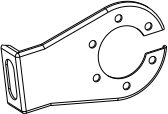
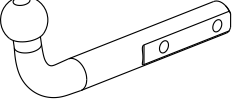
10.3662.12/11.3662.12

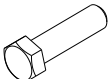
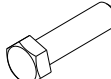
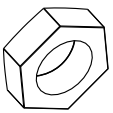
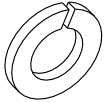
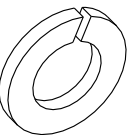
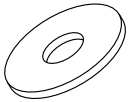
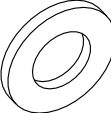
A  x1	B  x1	C  x1	D  x1	E  x1
F1  M10x1,25x35 x8	F2  M12x1,25x40 x4	F3  M12x1,25x70 x2	H  M12x1,25 x2	I1  Ø10G x8
I2  Ø12G x6	J  Ø10 x8	K  Ø12 x8		

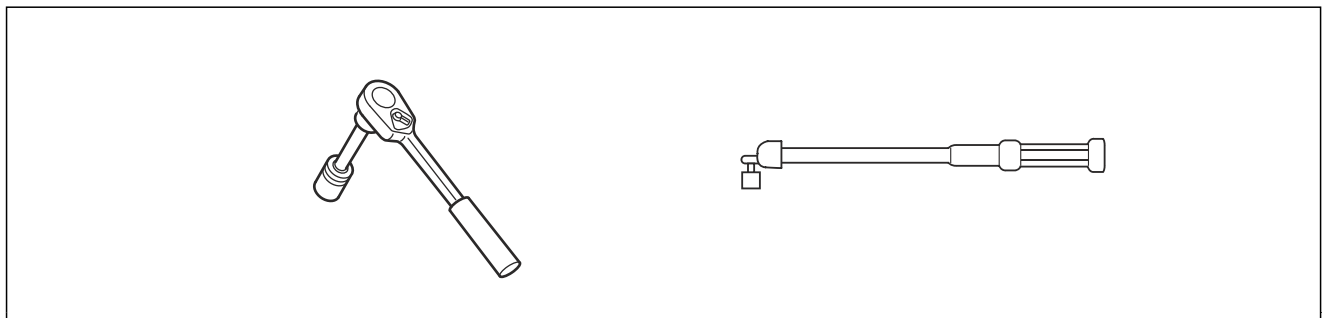

RU

Прежде чем начать установку, прочитайте данную инструкцию. Гарантия на продукцию предоставляется только в случае установки официальным дилером KIA.

Номер детали:
10.3662.12/11.3662.12

Страница
03



МЕТАЛЛОПРОДУКЦИЈА

Номер детали:

10.3662.12/11.3662.12

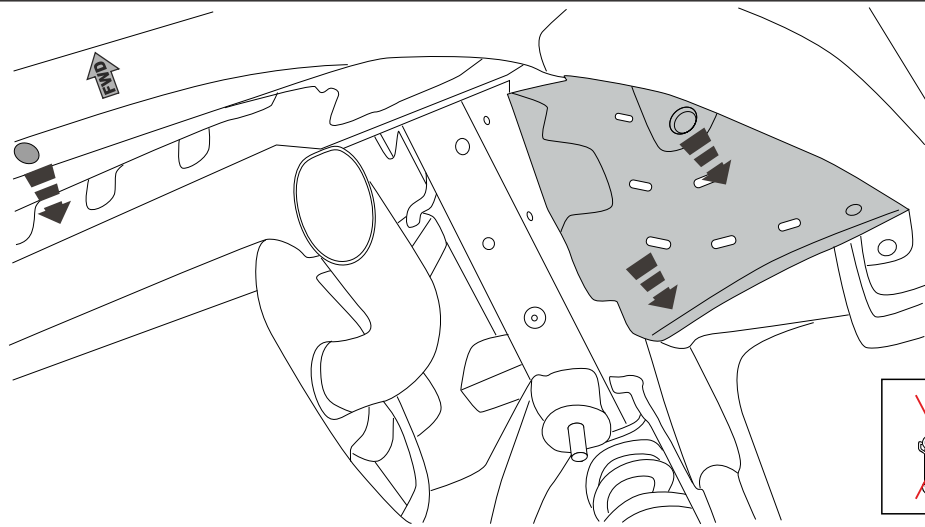

LHS=RHS

1

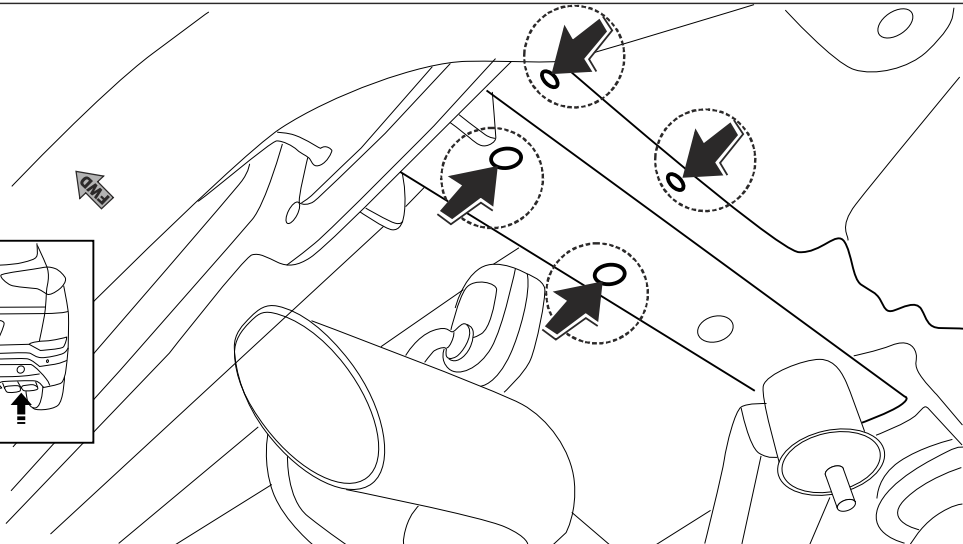

2

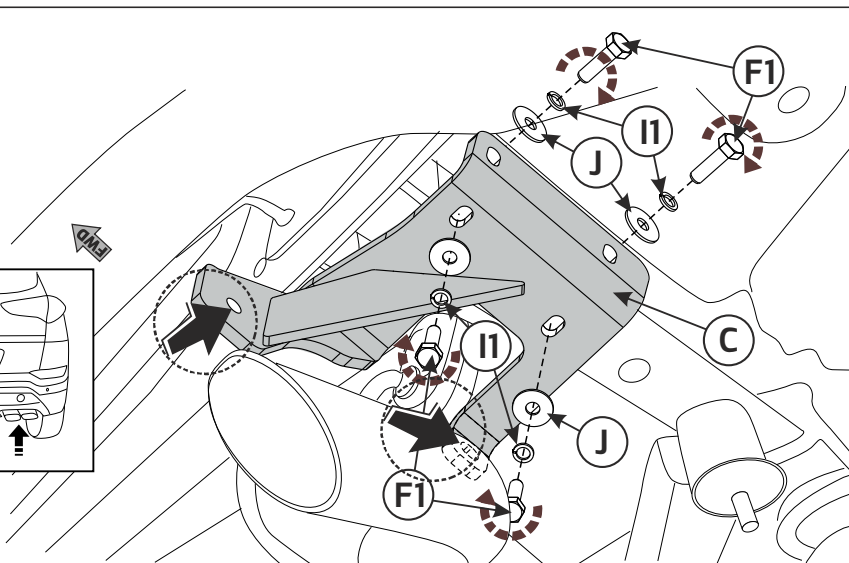

3

Номер детали:
10.3662.12/11.3662.12

Страница
04

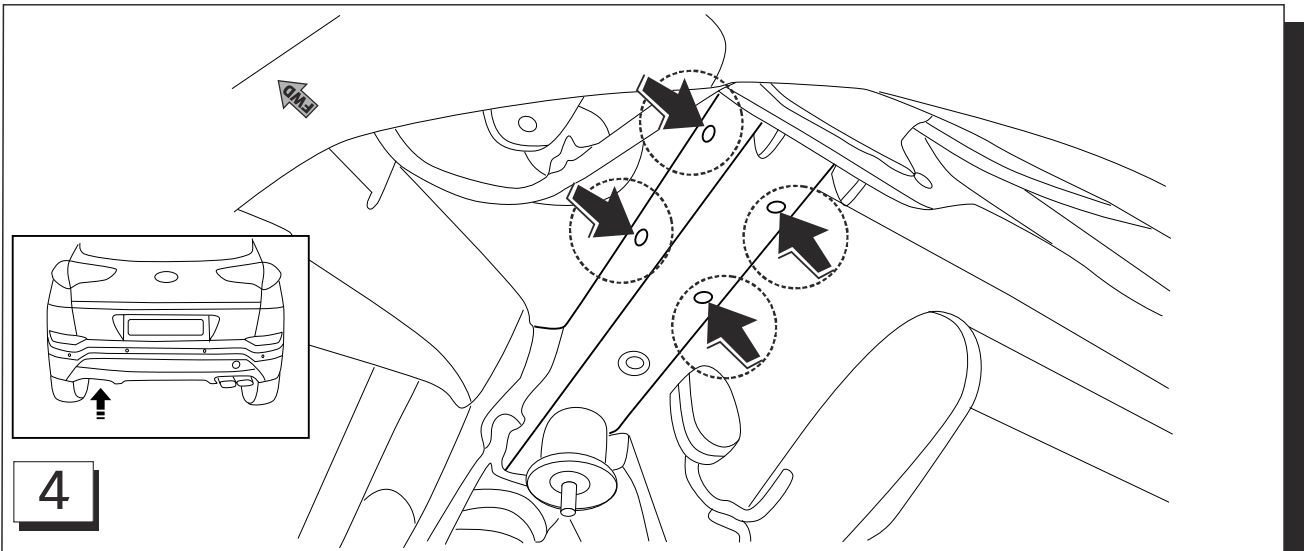

4

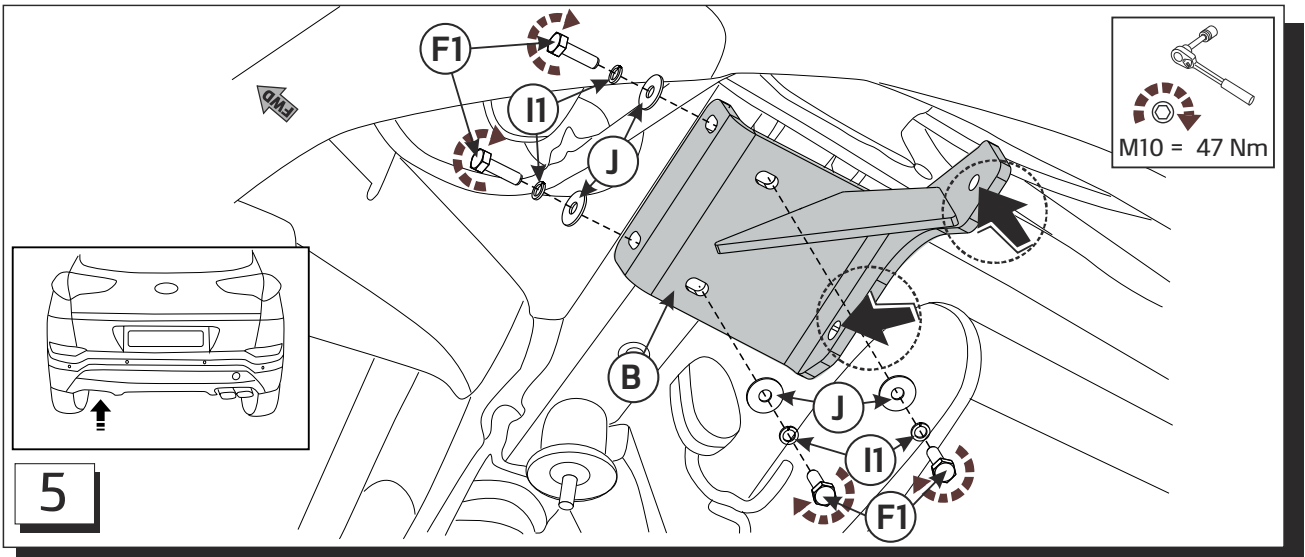

5

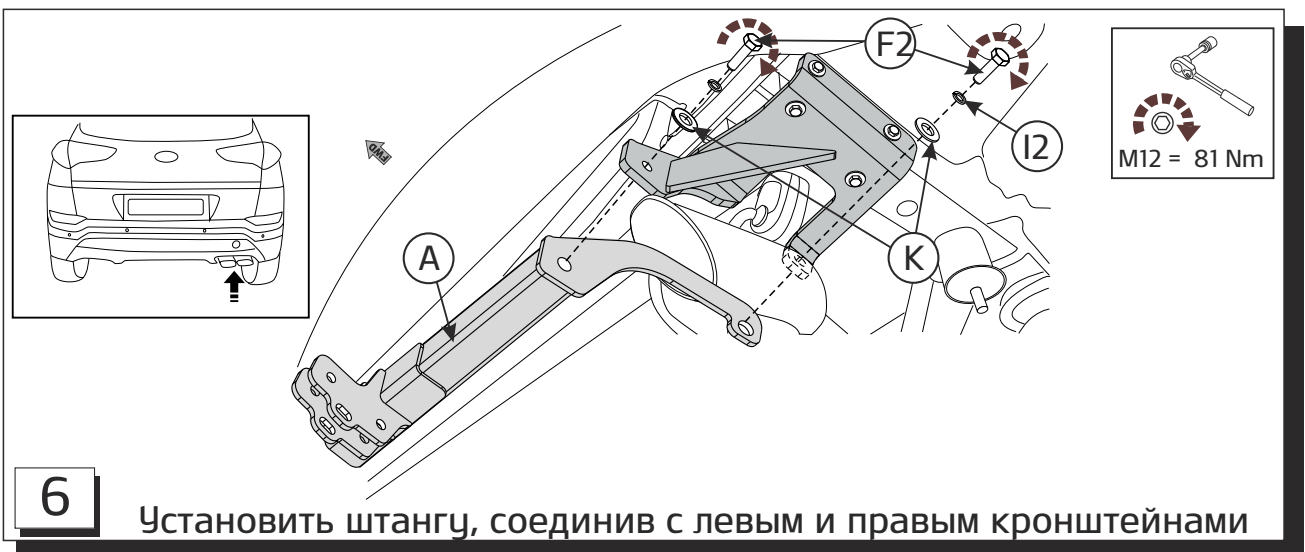

6

Установить штангу, соединив с левым и правым кронштейнами

