

Инструкция по установке

# Renault Sandero

(2014-)

# Renault Sandero Stepway

(2014-)

# Renault Logan

(2014-)

# Renault Logan Stepway

(2018-)



Арт.: F.4702.001

 1200 kg	 75 kg	$D \text{ (kN)} = \frac{\text{MAX kg} \times \text{MAX kg}}{\text{MAX kg} + \text{MAX kg}} \times 0,00981$
$D = 6.75 \text{ kN}$		

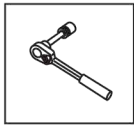

Вкрутить/выкрутить используя инструмент

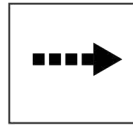

Движение

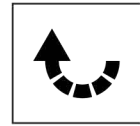

Поворот



Вкрутить/выкрутить не затягивая

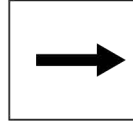

Расположение

### Используемый инструмент:

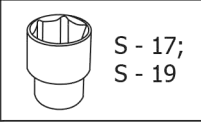
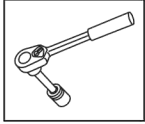







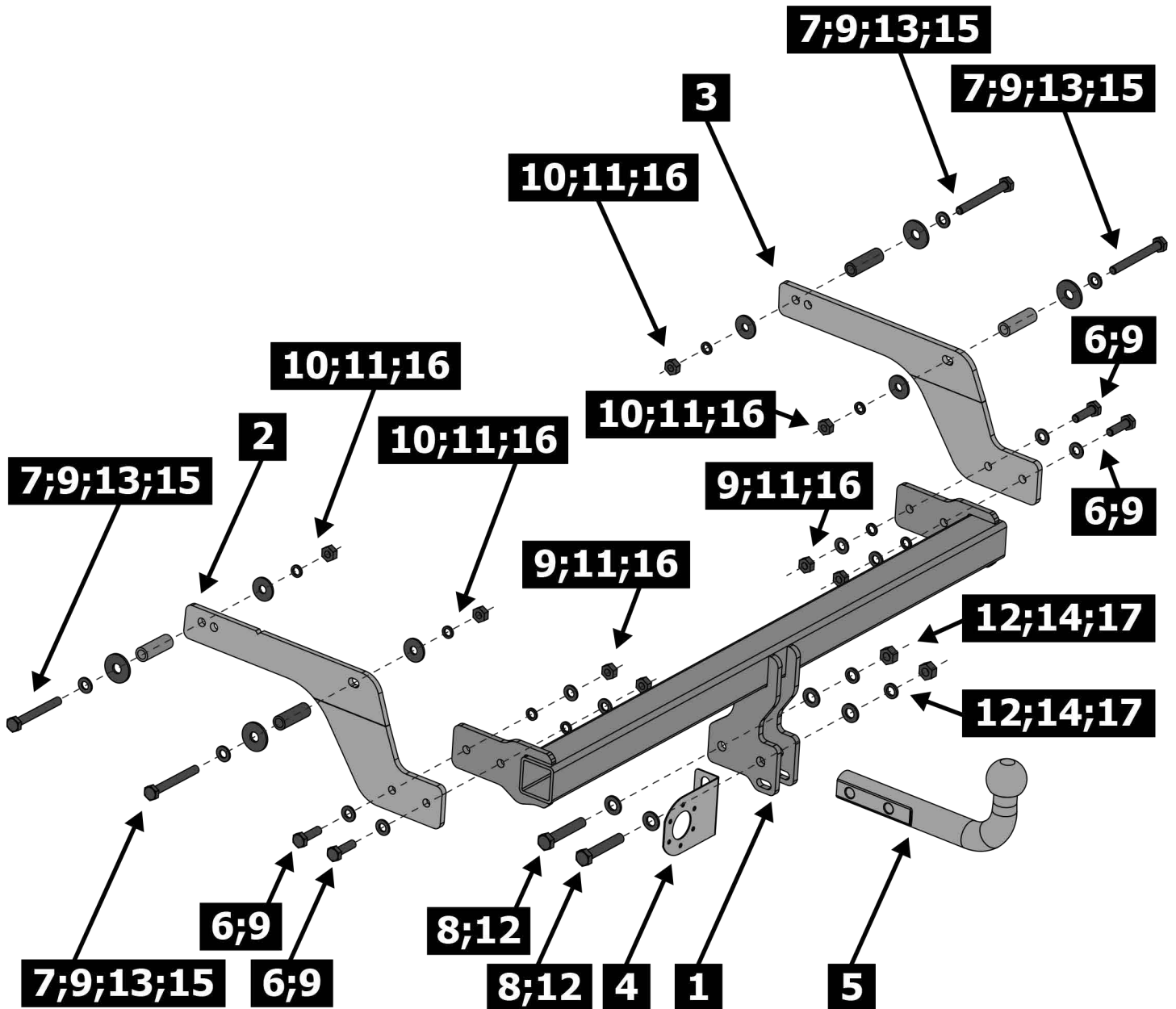

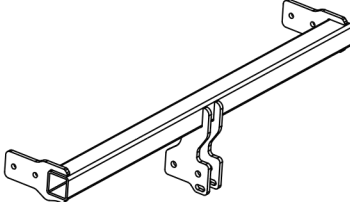
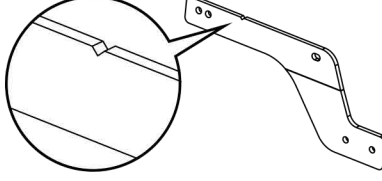
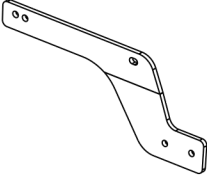

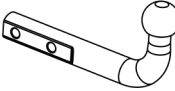



S - 17;  
S - 19



Office Knife

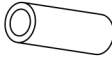

<b>1</b>	x1	Балка	
<b>2</b>	x1	Кронштейн левый	
<b>3</b>	x1	Кронштейн правый	
<b>4</b>	x1	Подрозетник	
<b>5</b>	x1	Крюк	
<b>6</b>	x4	M10x35	
<b>7</b>	x4	M10x90	
<b>8</b>	x2	M12x1.25x70	
<b>9</b>	x12	∅ 10	
<b>10</b>	x4	∅ 10	
<b>11</b>	x8	∅ 10	
<b>12</b>	x4	∅ 12	
<b>13</b>	x4	∅ 12	
<b>14</b>	x2	∅ 12	
<b>15</b>	x4	Втулка 53 мм	
<b>16</b>	x8	M10	
<b>17</b>	x2	M12x1.25	

Sandero

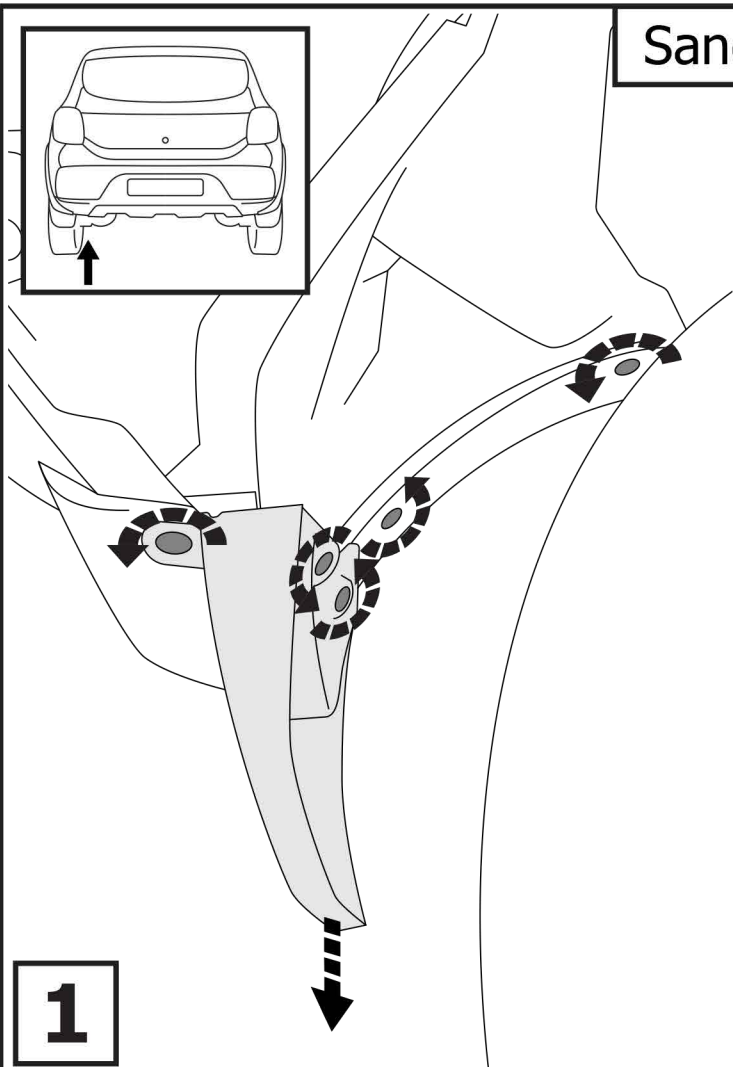
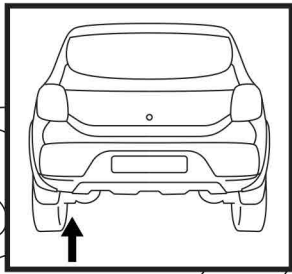

**1**

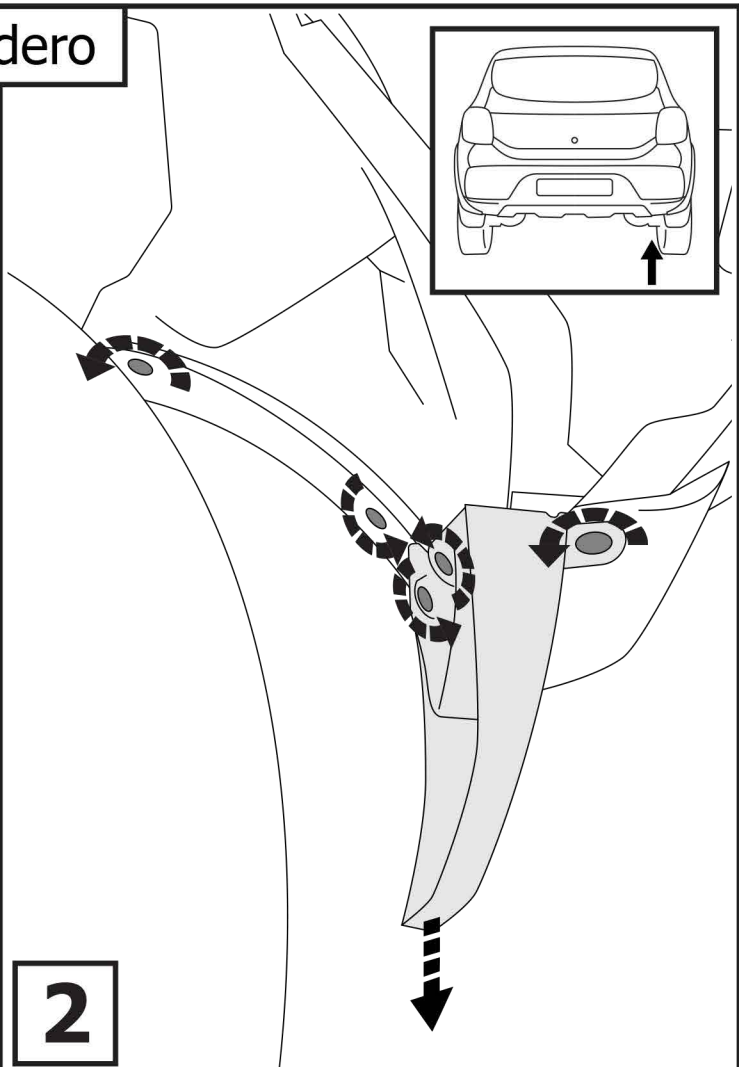
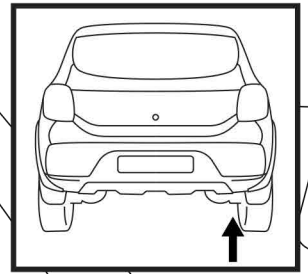

**2**

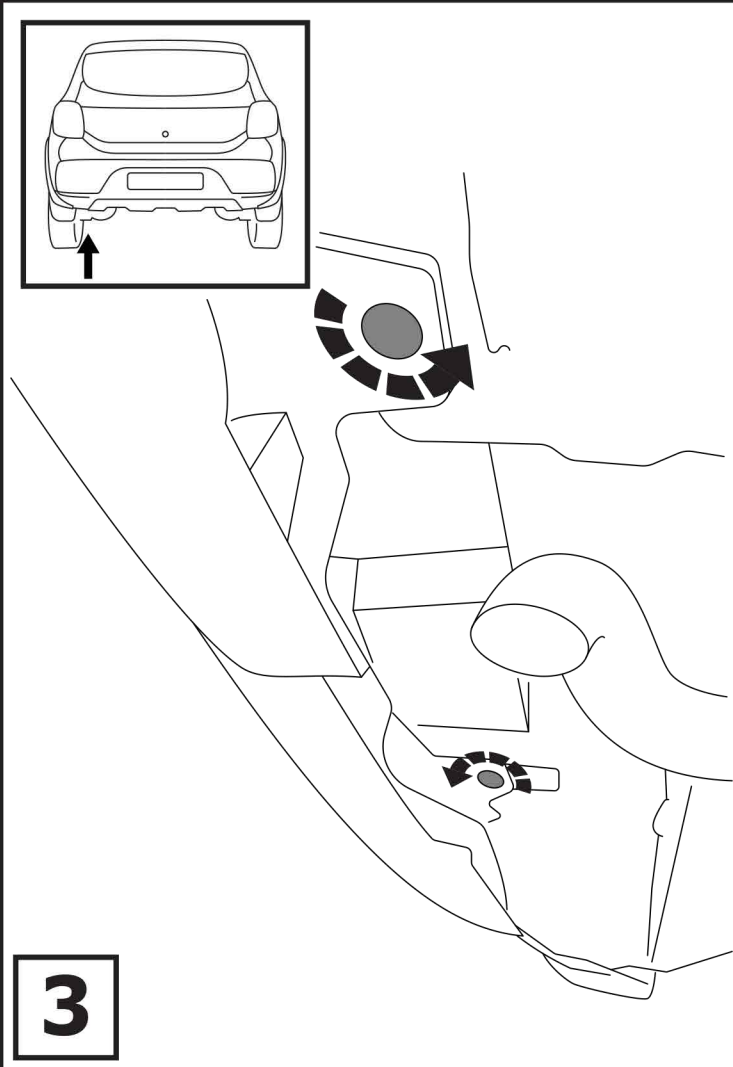
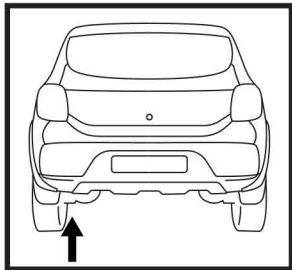

**3**

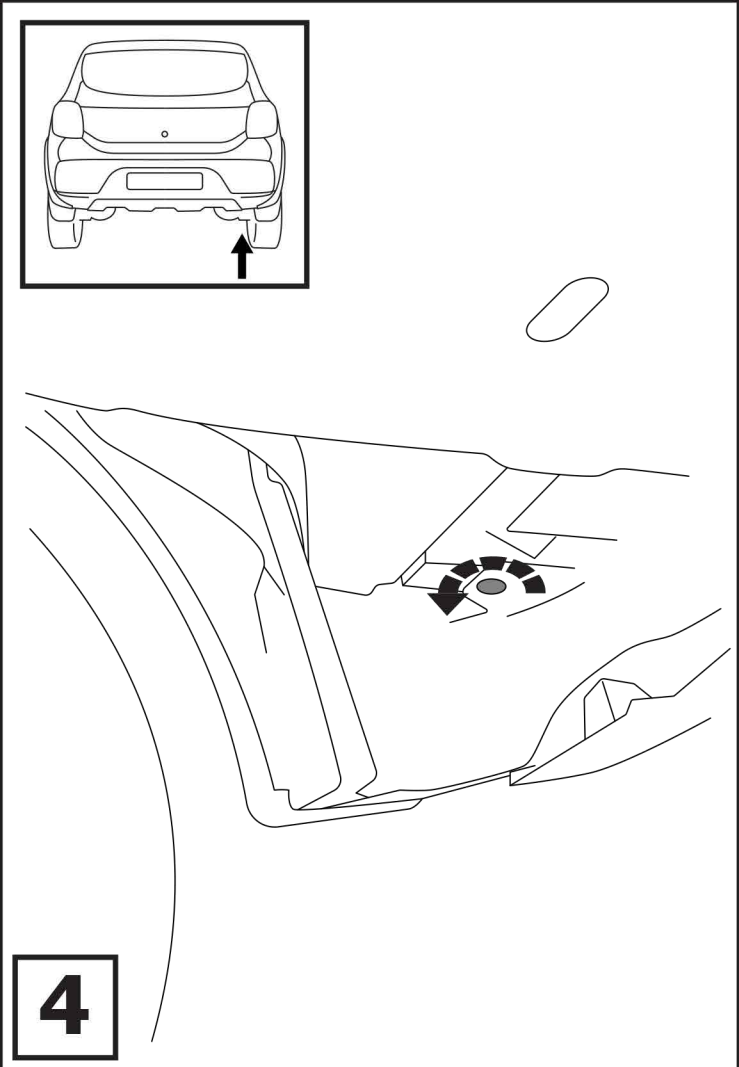
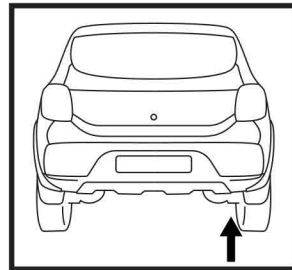

**4**

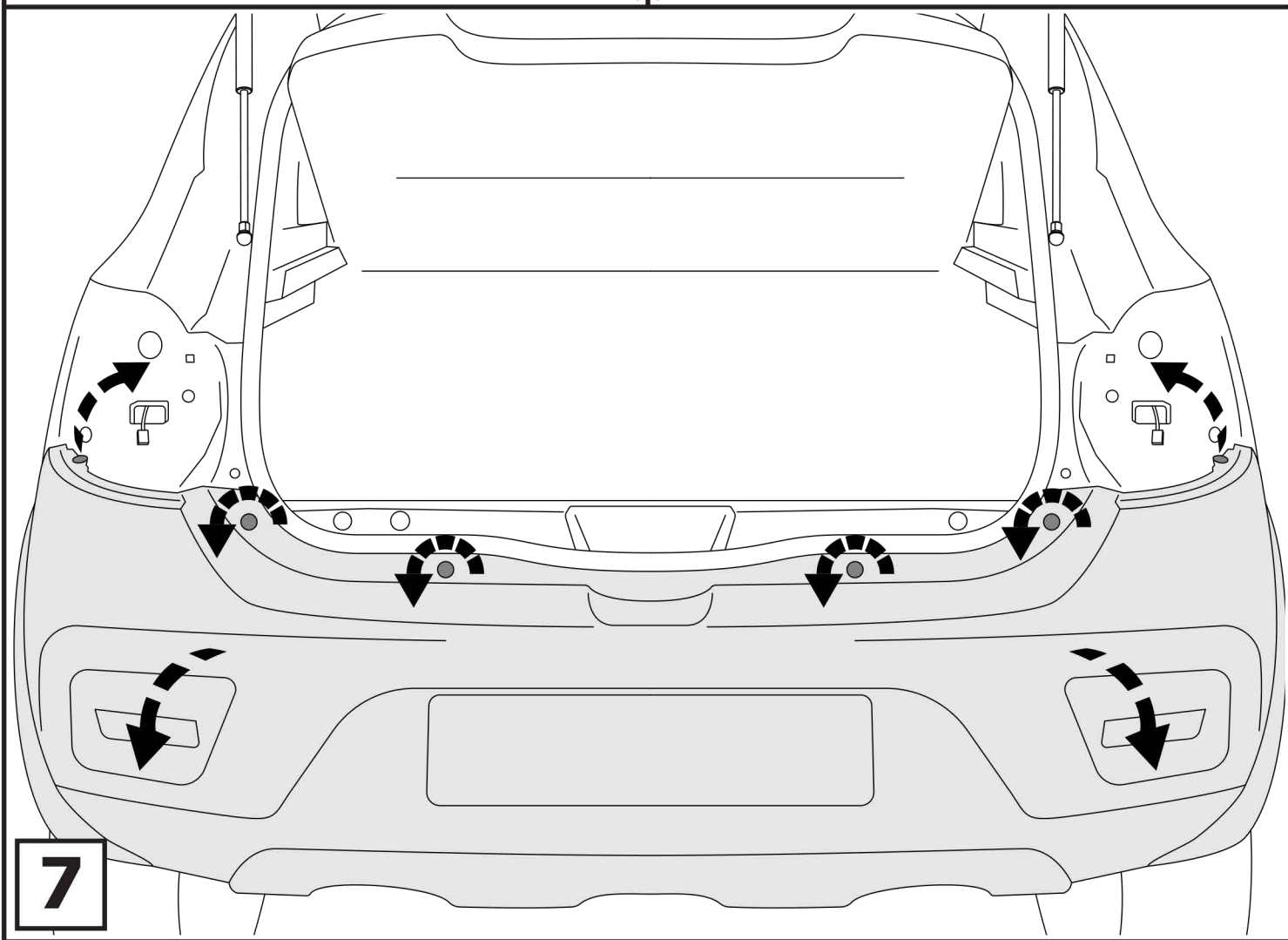
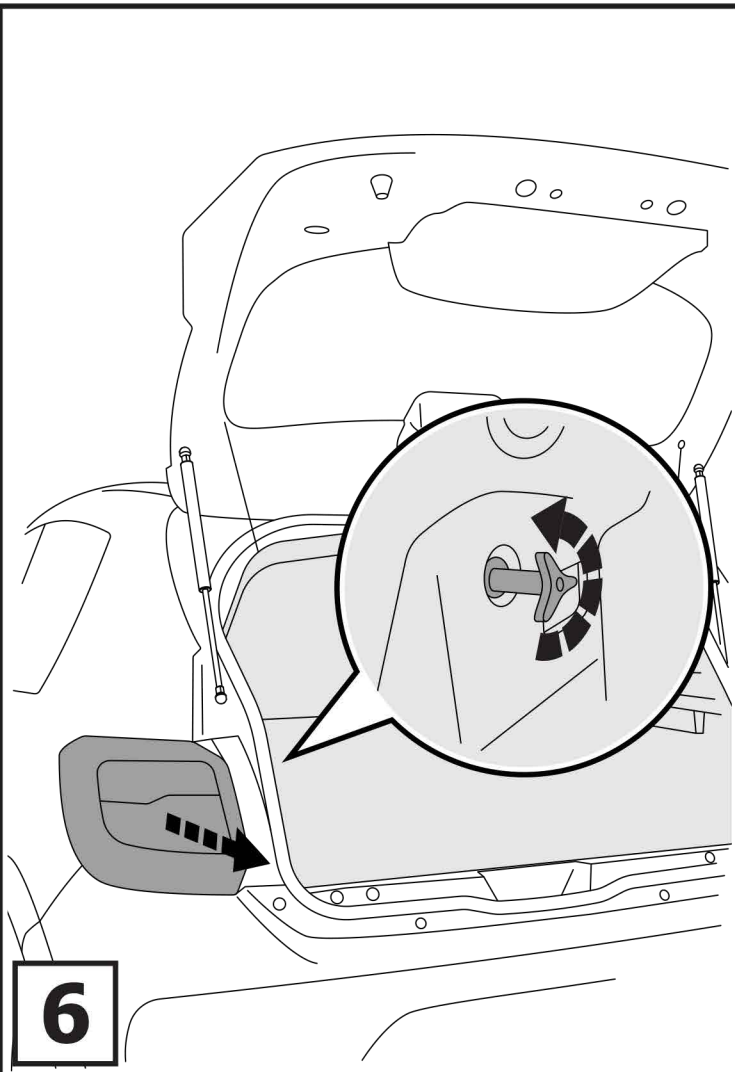
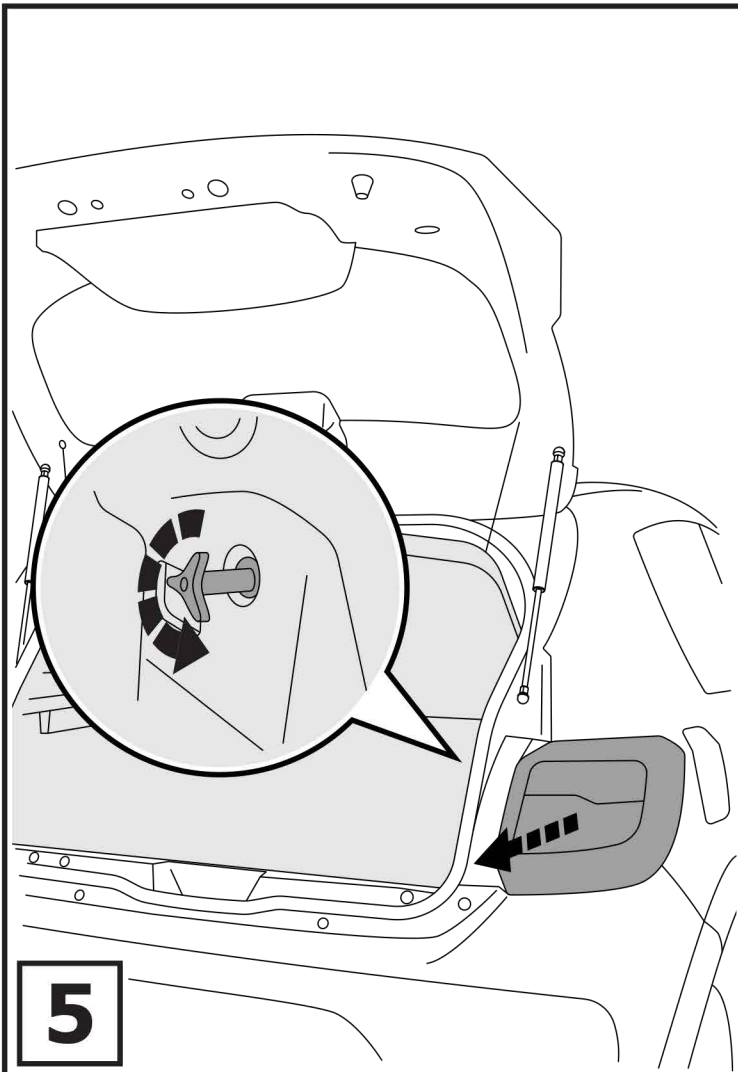

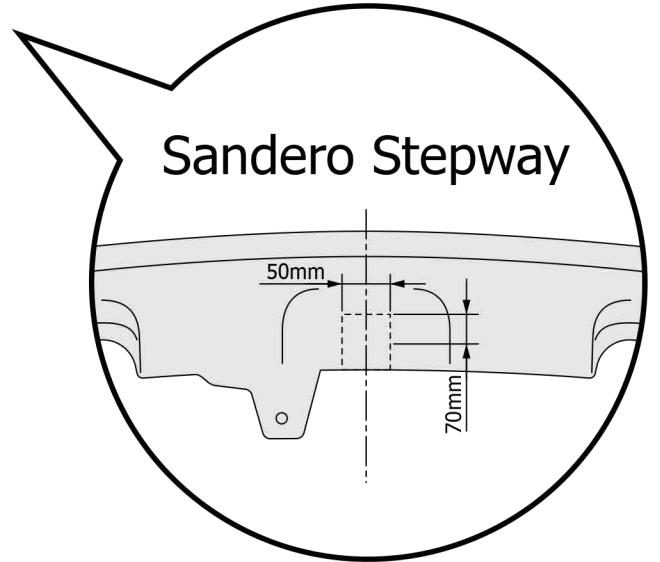
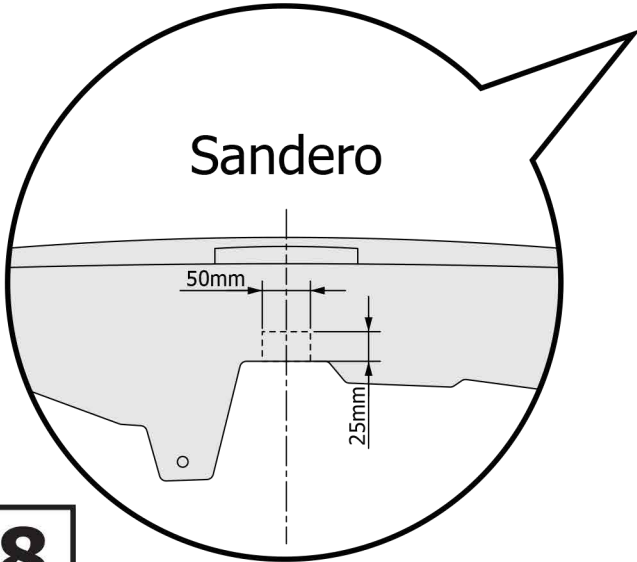
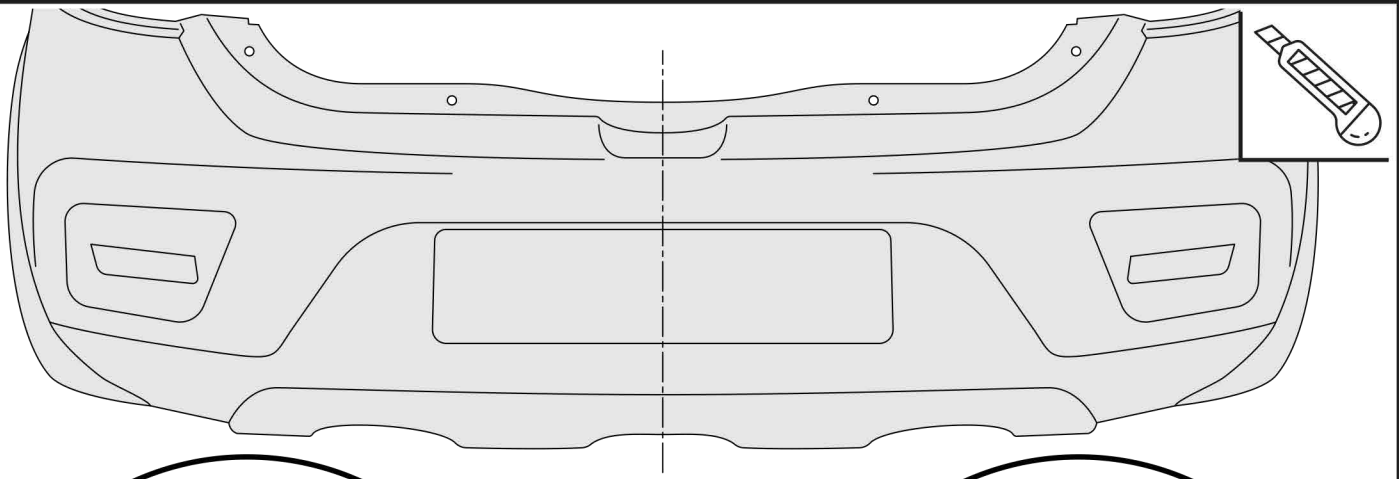

**8**

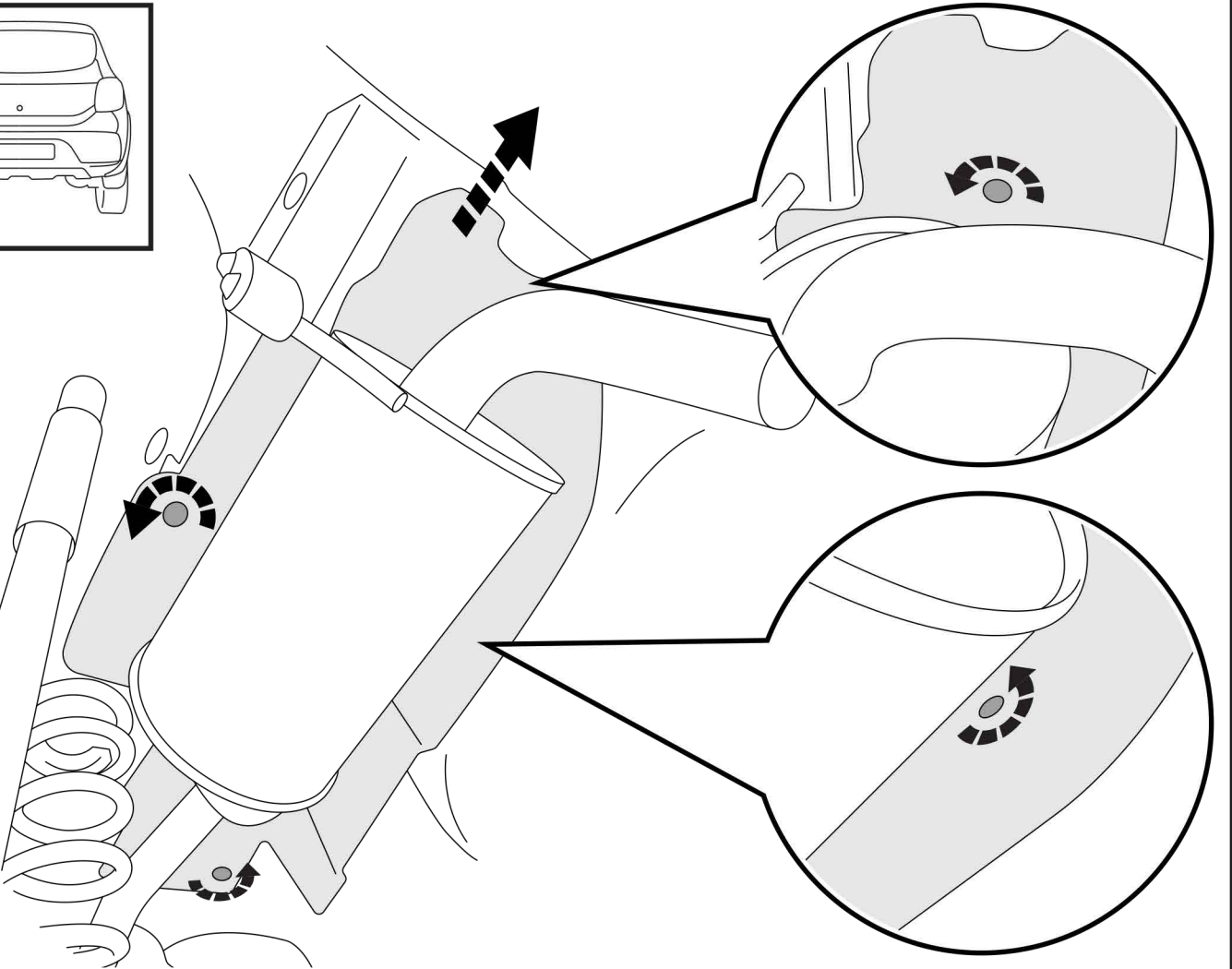
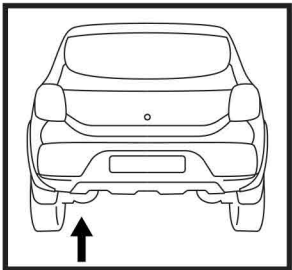

**9**

Sandero / Logan

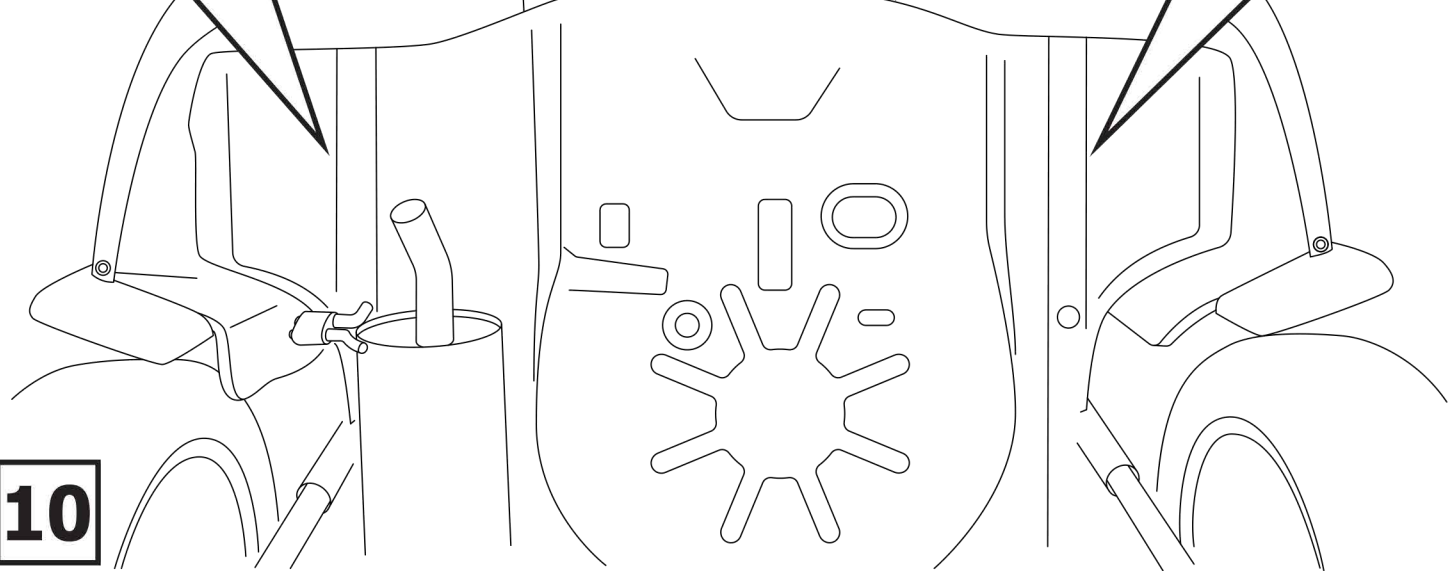
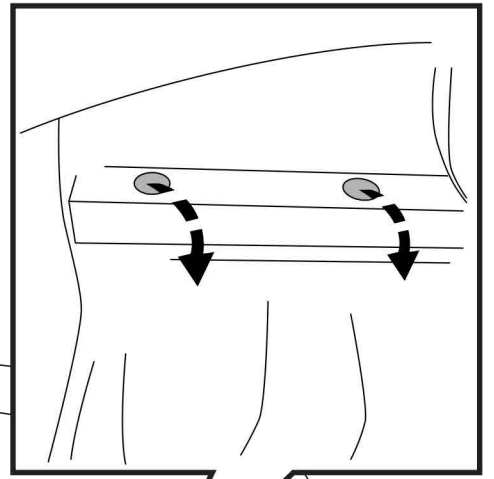
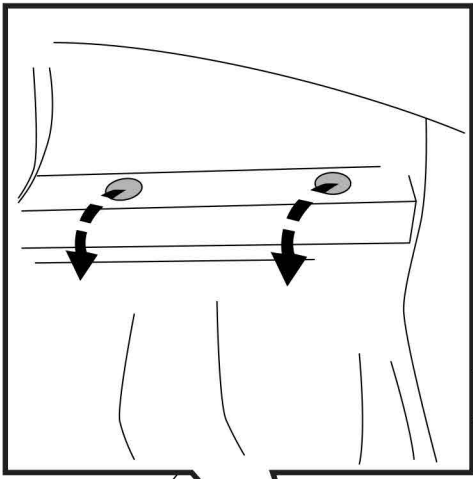

**10**

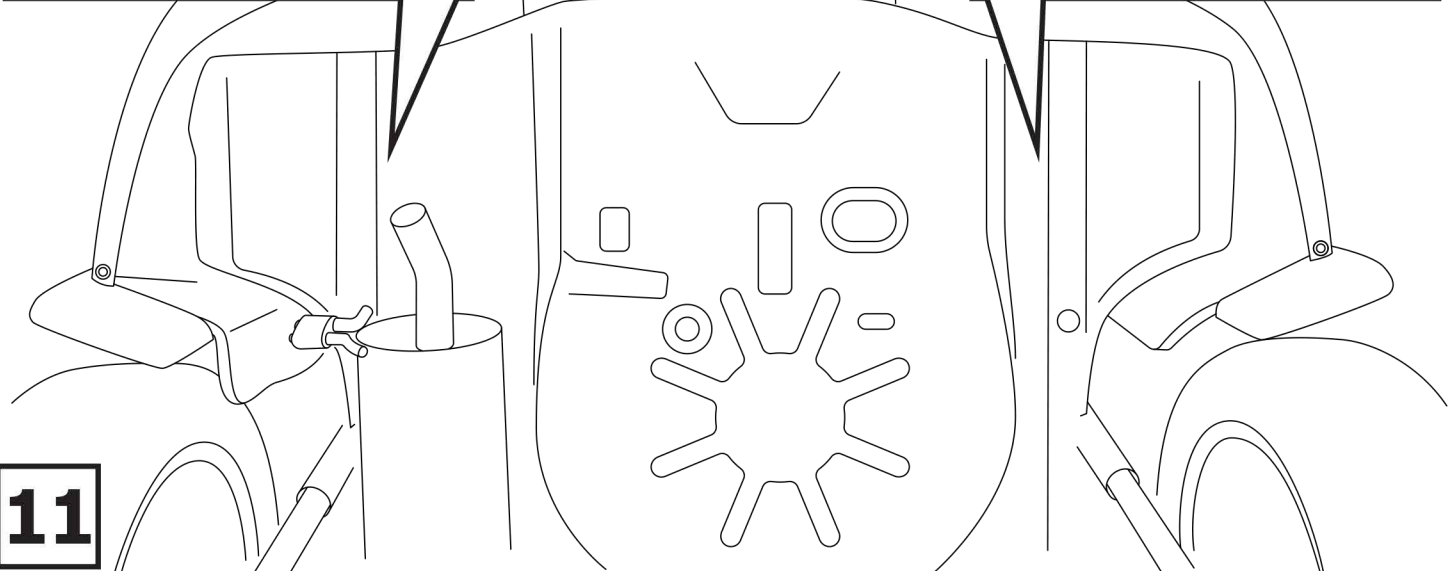
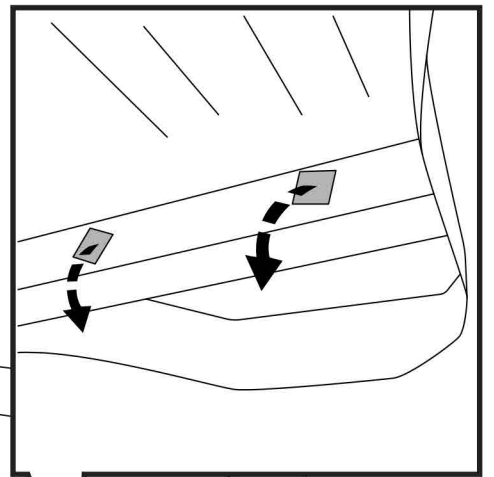
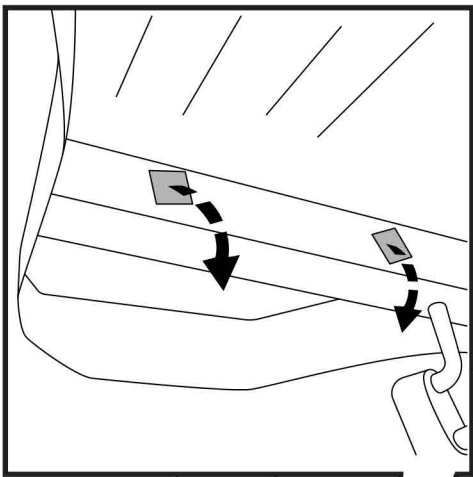

**11**

