



2006 -

OPEL CORSA D

Cat. No. O/033

e20

e20*94/20*0673*00

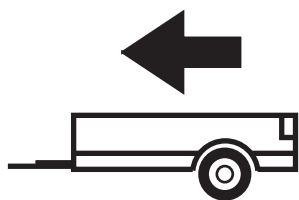

1350Kg

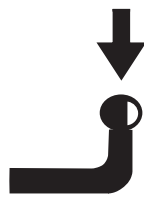

55Kg

D = 7,66kN

D (kN) =



MAX kg

x

MAX kg

x 0,00981



MAX kg

+

MAX kg



IMIOLA HAK-POL

96-111 KOWIESY, CHOJNATA 23A, POLAND

tel. +48 46 831 73 31, fax +48 831 74 29

e-mail: office@imiola.pl, www.imiola.pl

PRZEKRÓJ A-A

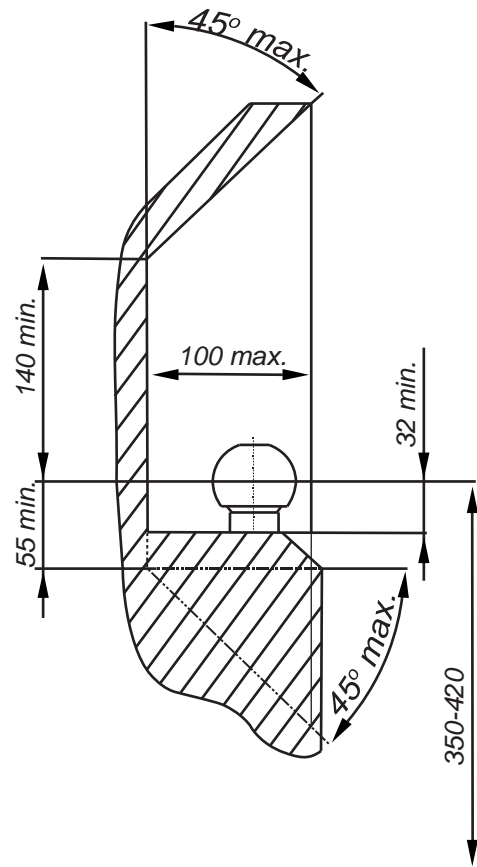
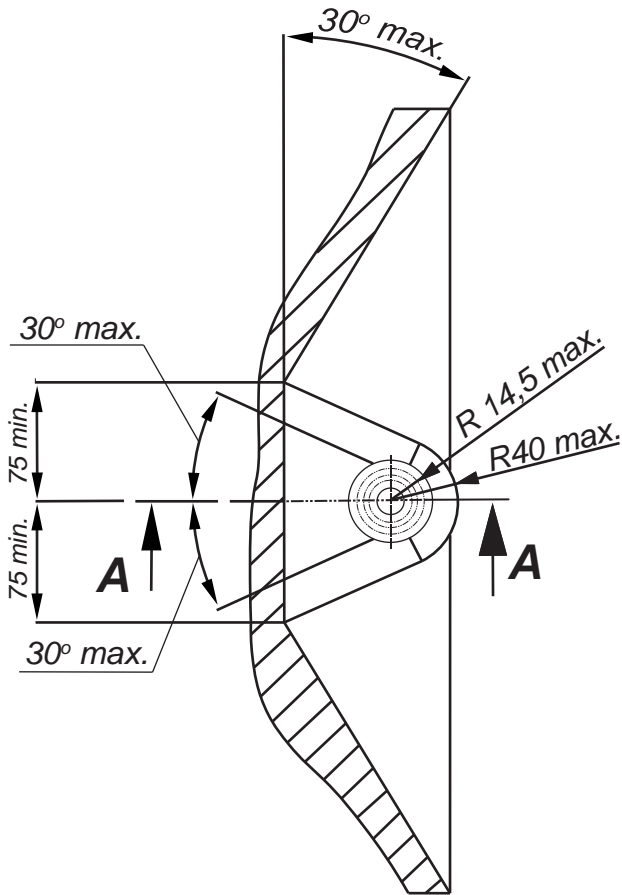

PL Należy zagwarantować przestrzeń swobodną według załącznika VII, rysunek 25a/b Regulaminu EKG ONZ 55.01 przy dopuszczalnym ciężarze całkowitym pojazdu.

F L'espace libre doit être garanti conformément à l'annexe VII, illustration de la réglementation 55.01 CE pour un poids total en charge autorisé du véhicule.







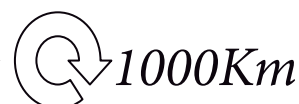

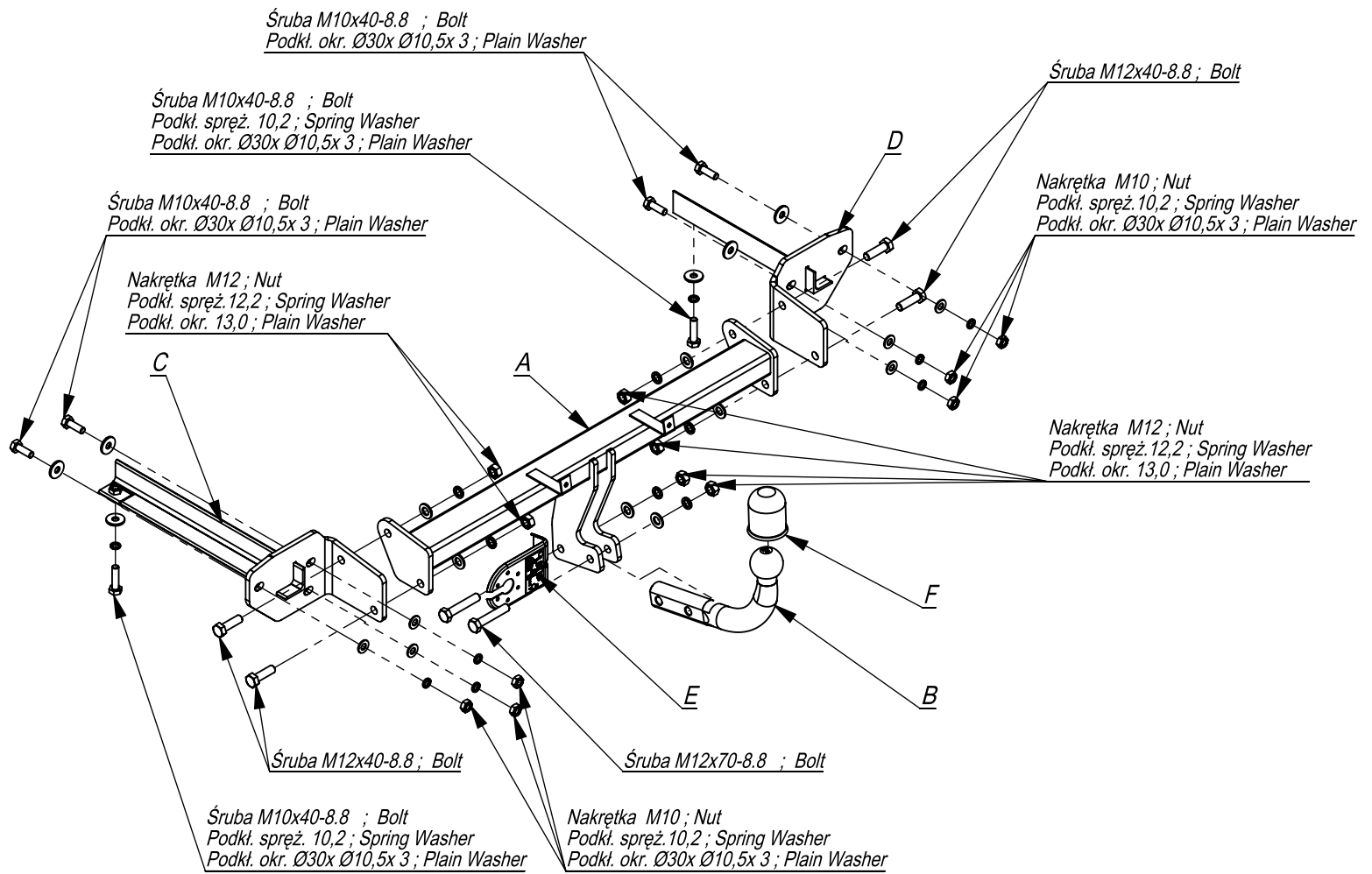
GB The clearance specified in appendix VII, diagram 25a/b of Regulation No. 55.01 UN EU must be guaranteed at laden weight of the vehicle.

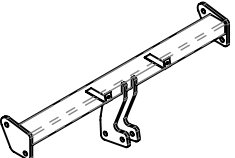
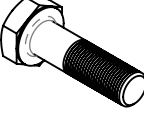
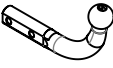
D Der Freiraum nach Anhang VII, Abbildung 25a/b der Vorschriften 55.01 EG ist zu gew 25a/b abzuwehren bei zulässigem Gesamtgewicht des Fahrzeuges.

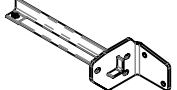
Moment skracający dla śrub i nakrętek (8.8) Torque settings for nuts and bolts (8.8)	
M8	25Nm
M10	55Nm
M12	85Nm
M14	135Nm
M16	195Nm

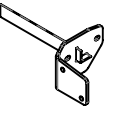



	A	x1		M12x70	2
				M12x40	4
				M10x40	6
	B	x1		M12	6
				M10	6
	C	x1		Ø30xØ10,5x3	12
				Ø15xØ10,5x3	2
	D	x1		13	6
	E	x1		12,2	6
				10,2	8
	F	x1			

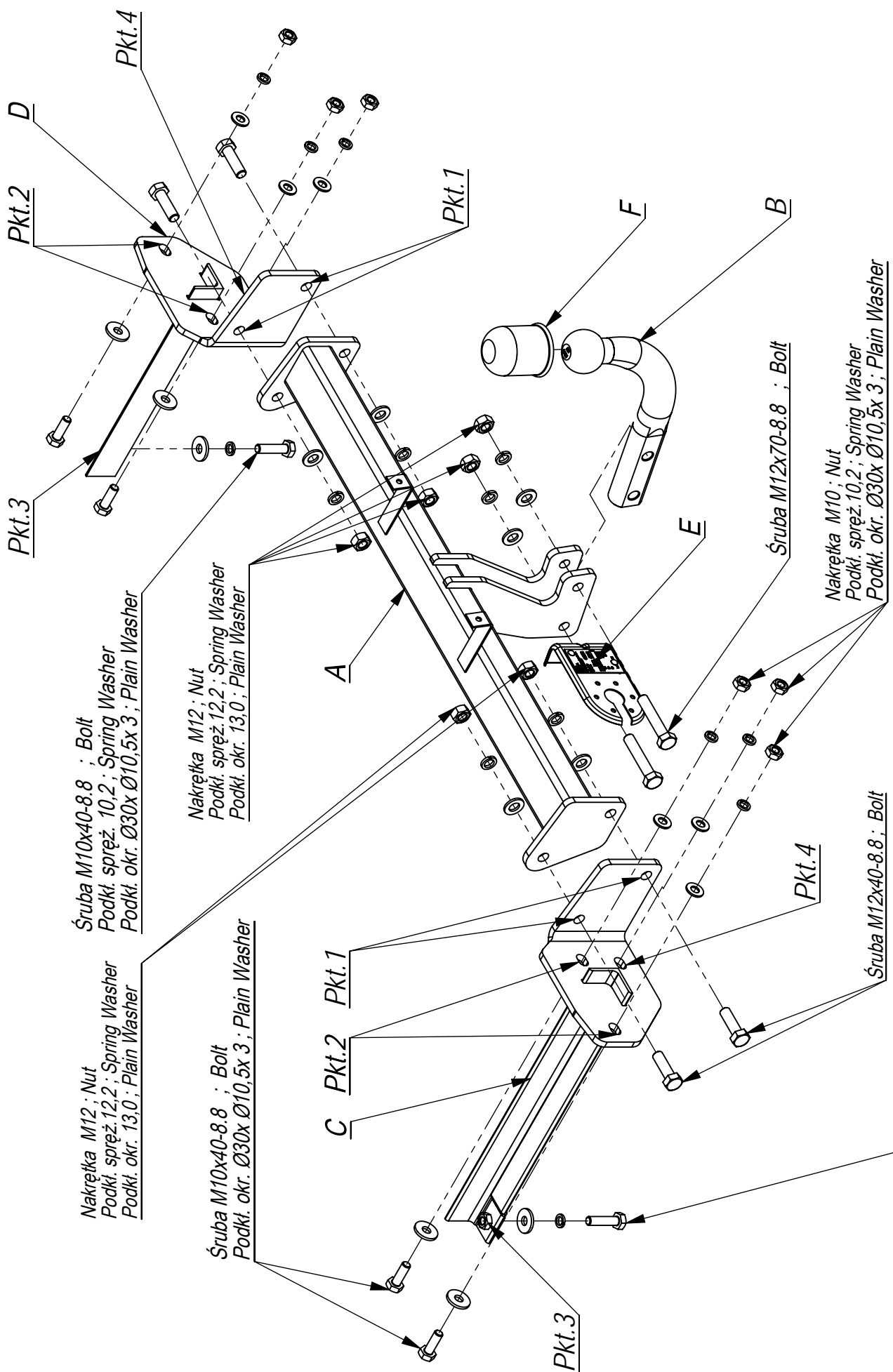

Nakrętka M12; Nut
Podkł. spręż. 12,2; Spring Washer
Podkł. okr. Ø30x Ø10,5x 3; Plain Washer

Śruba M10x40-8.8 ; Bolt
Podkł. spręż. 10,2; Spring Washer
Podkł. okr. Ø30x Ø10,5x 3; Plain Washer

Nakrętka M12; Nut
Podkł. spręż. 12,2; Spring Washer
Podkł. okr. 13,0; Plain Washer

Śruba M10x40-8.8 ; Bolt
Podkł. okr. Ø30x Ø10,5x 3; Plain Washer

Śruba M12x70-8.8 ; Bolt

Nakrętka M10; Nut
Podkł. spręż. 10,2; Spring Washer
Podkł. okr. Ø30x Ø10,5x 3; Plain Washer

Śruba M12x40-8.8 ; Bolt

Śruba M10x40-8.8 ; Bolt
Podkł. spręż. 10,2; Spring Washer
Podkł. okr. Ø30x Ø10,5x 3; Plain Washer

- Odkręcić zderzak oraz metalowe wzmocnienie (nie będzie już wykorzystane).
- Elementy zaczepu C i D wsunąć do podłużnic. Poprzez technologiczne otwory od spodu podłużnic przykręcić śrubami M10x40 8.8 (pkt 3) oraz nakręcić nakrętki M10 na wystające szpilki z tylnego pasa (pkt 2).
- Do elementów C i D przykręcić belkę haka A śrubami M12x35 8.8 (pkt 1).
- Na uchwyty znajdujące się na belce haka A należy zamontować plastikowe elementy znajdujące się na metalowym wzmocnieniu.
- Dokręcić wszystkie śruby z momentem jak w tabeli.
- W dolnej części zderzaka wykonać wycięcie o wymiarach: 50 mm szerokość x 40 mm głębokość.
- Przykręcić zderzak.
- Podłączyć instalację elektryczną.
- Przykręcić kulę i blachę gniazda elektrycznego śrubami M12x70 8.8.

- Unscrew the bumper and metal reinforcement (it will not be used any more).
- Insert the elements C and D in the metal clamps. Screw with bolts M10x40 8.8 (point 3) through the technological holes of the bottom of the metal clamps and twist on the nuts M10 on the protruding pins from the rear belt (point 2).
- Screw the main bar A to the elements C and D with bolts M12x35 8.8 (point 1).
- Assemble the plastic elements, which are placed on the metal reinforcement, on the handles of the main bar A.
- Tighten all the bolts according to the torque setting- see the table.
- Cut out the fragment of the bumper, in his lower part: the width 50 mm, the height 40 mm.
- Screw the bumper.
- Connect the electric wires.
- Fix the ball and electric plate with bolts M12x70 8.8.

- Dévisser le pare-chocs avec le renforcement en métal (il n'est sera plus utilisé).
- Infiltrer les éléments C et D dans les longerons. A l'aide des trous technologiques du bas des longerons serrer les boulons M10x40 8.8 (point 3) et visser les écrous M10 sur les épingles de la bande postérieure (point 2).
- Serrer la poutre du crochet A à l'élément du crochet d'attelage C et D avec les boulons M12x35 8.8 (point 1).
- Sur le crochet d'attelage A de la poutre, monter les éléments en plastique qui se trouvent sur le renforcement en métal.
- Serrer tous les boulons avec un couple de serrage selon tableau.
- Ouvrir la partie basse de pare-chocs de 50 (largeur) x 40 (hauteur).
- Serrer le pare-chocs.
- Raccorder le circuit électrique.
- Visser le crochet d'attelage et socle de prise électrique à l'aide des boulons M12x70 8.8.

