

Инструкция по установке

LADA Granta HB

(2019-)



Арт.: F.6017.001

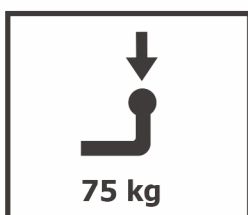
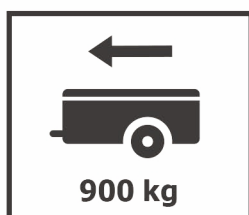

$D = 6,33 \text{ kN}$

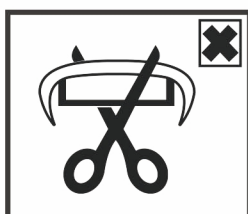

$$D \text{ (kN)} = \frac{\text{MAX kg} \times \text{MAX kg}}{\text{MAX kg} + \text{MAX kg}} \times 0,00981$$

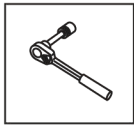

Вкрутить/выкрутить используя инструмент

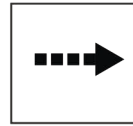

Движение

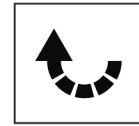

Поворот



Вкрутить/выкрутить не затягивая

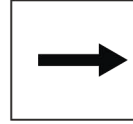





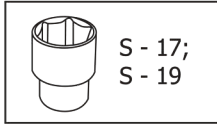
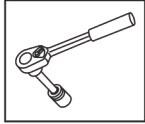

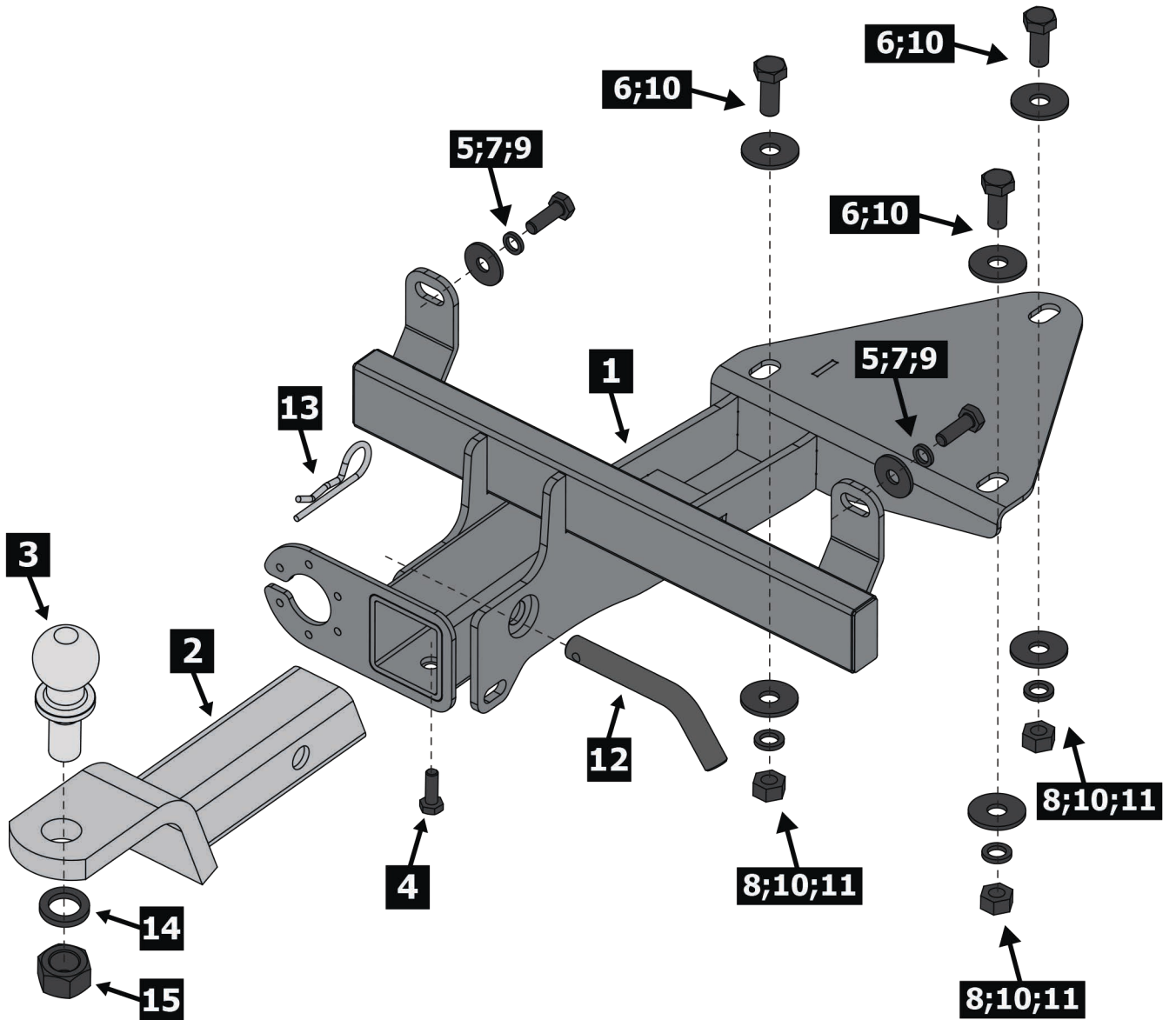

Расположение

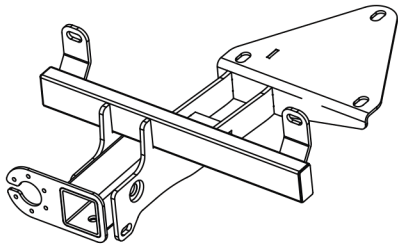
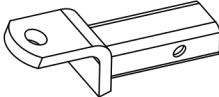
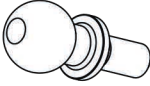
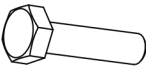
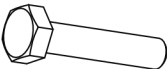
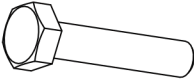
Используемый инструмент:

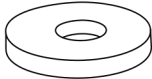
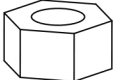

S - 17;
S - 19

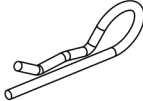

| | | | |
|-----------|----|-------------|---|
| 1 | x1 | Балка |  |
| 2 | x1 | Переходник |  |
| 3 | x1 | Шар |  |
| 4 | x1 | M10x20 |  |
| 5 | x2 | M10x1.25x25 |  |
| 6 | x3 | M12x30 |  |
| 7 | x2 | ∅ 10 |  |
| 8 | x3 | ∅ 12 |  |
| 9 | x2 | ∅ 10 |  |
| 10 | x6 | ∅ 12 |  |
| 11 | x3 | M12 |  |
| 12 | x1 | Штифт |  |
| 13 | x1 | Шплинт |  |
| 14 | x1 | ∅24 |  |
| 15 | x1 | M24 |  |

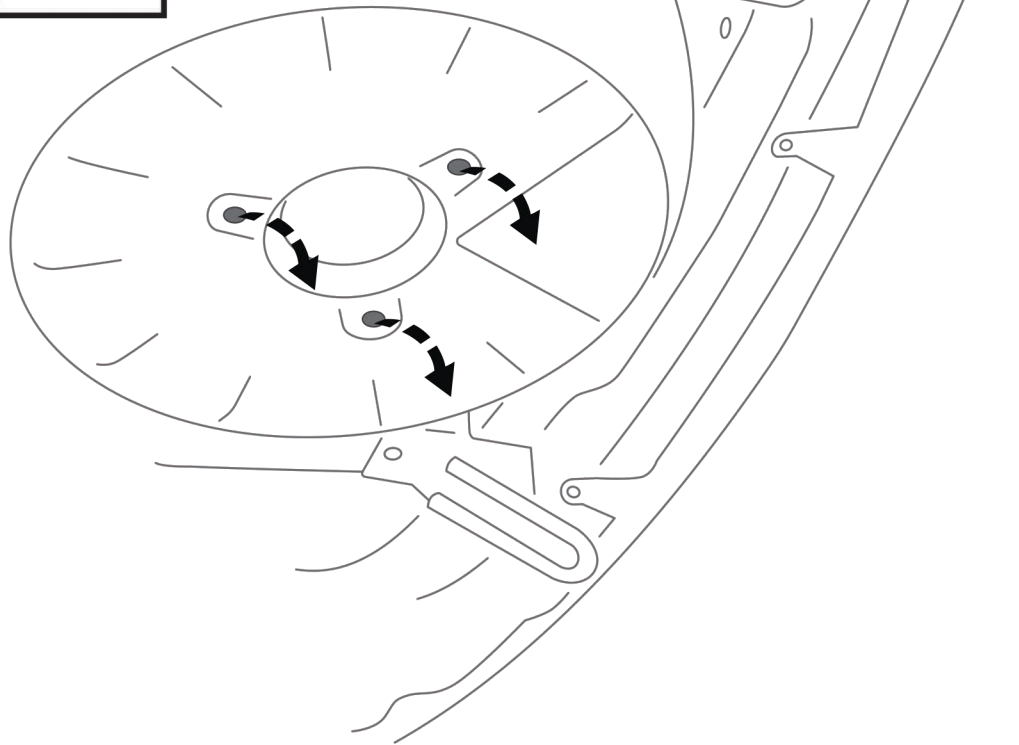
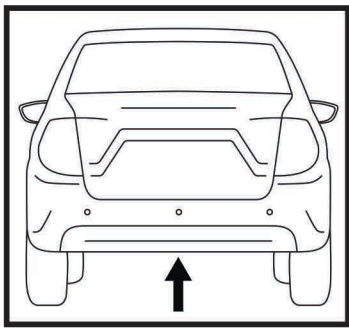

1

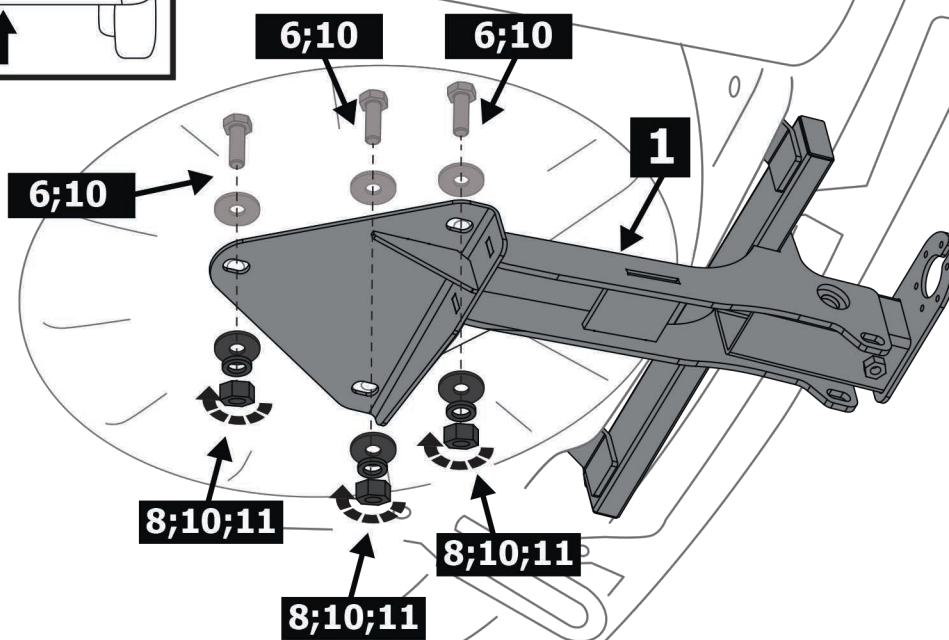
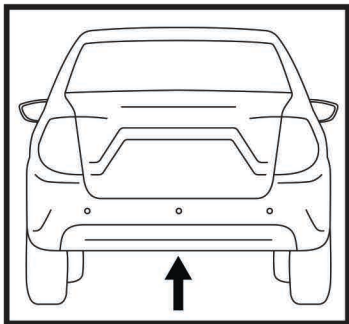

2

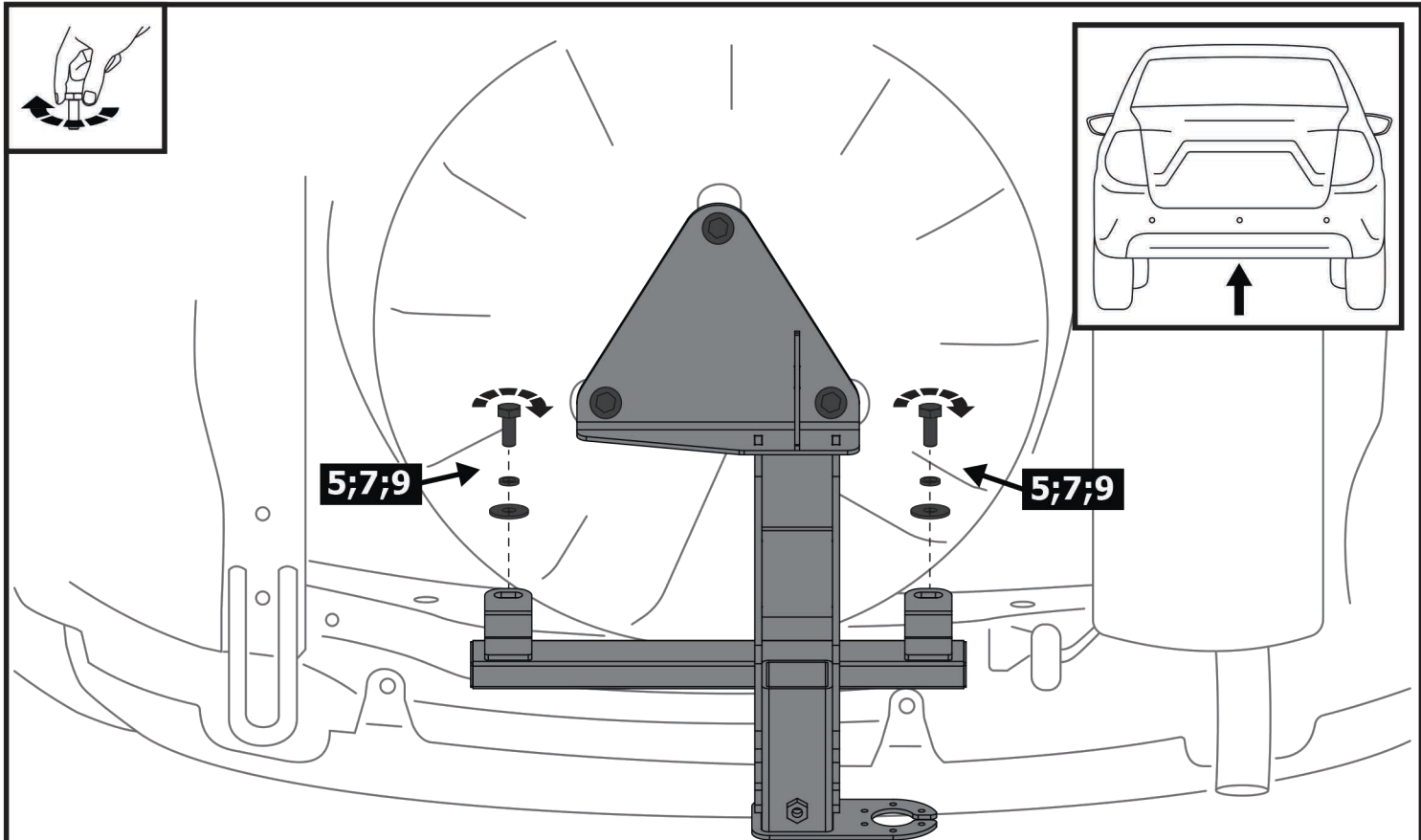

3

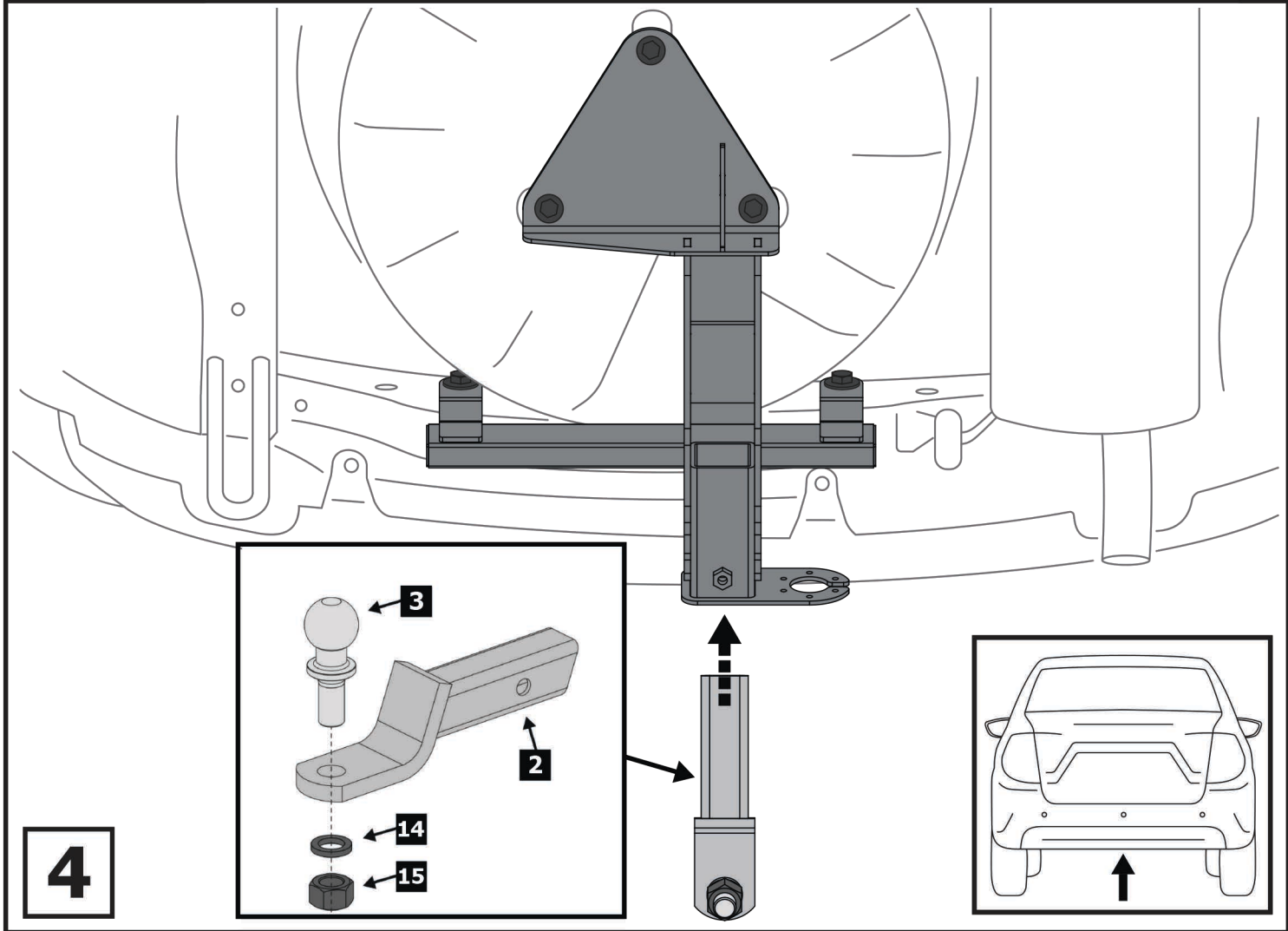

4

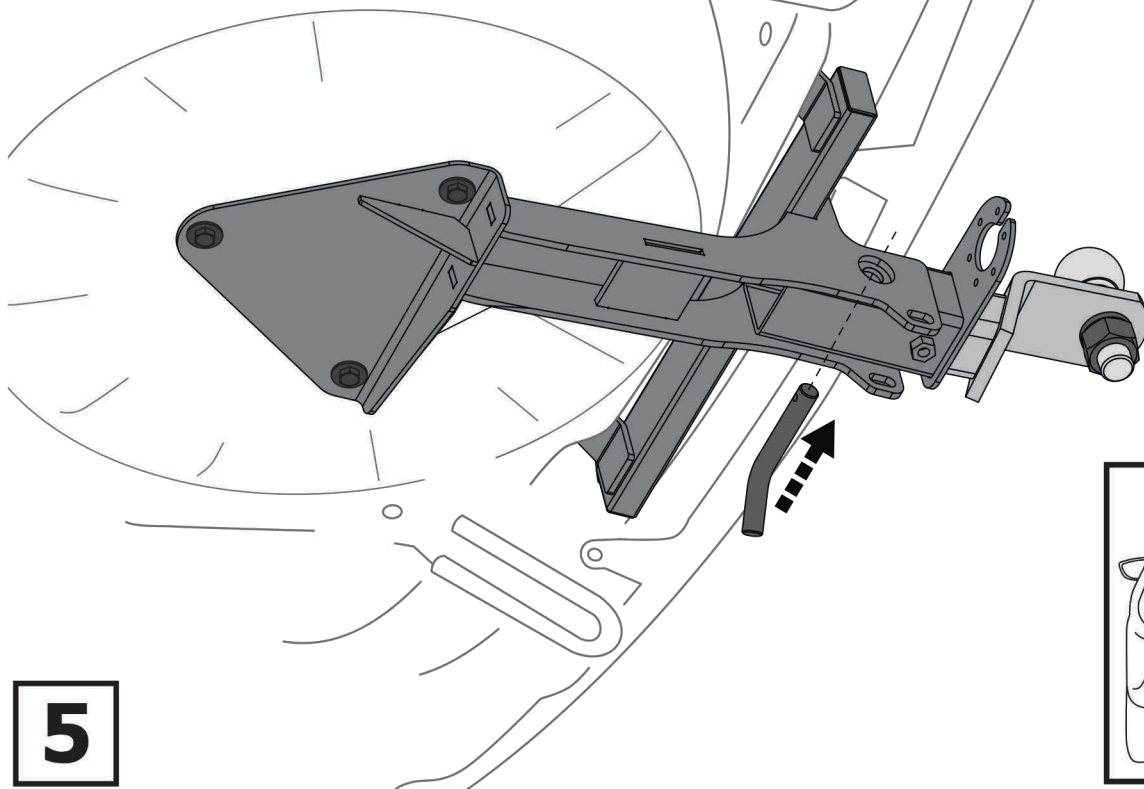
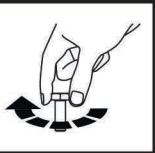

5

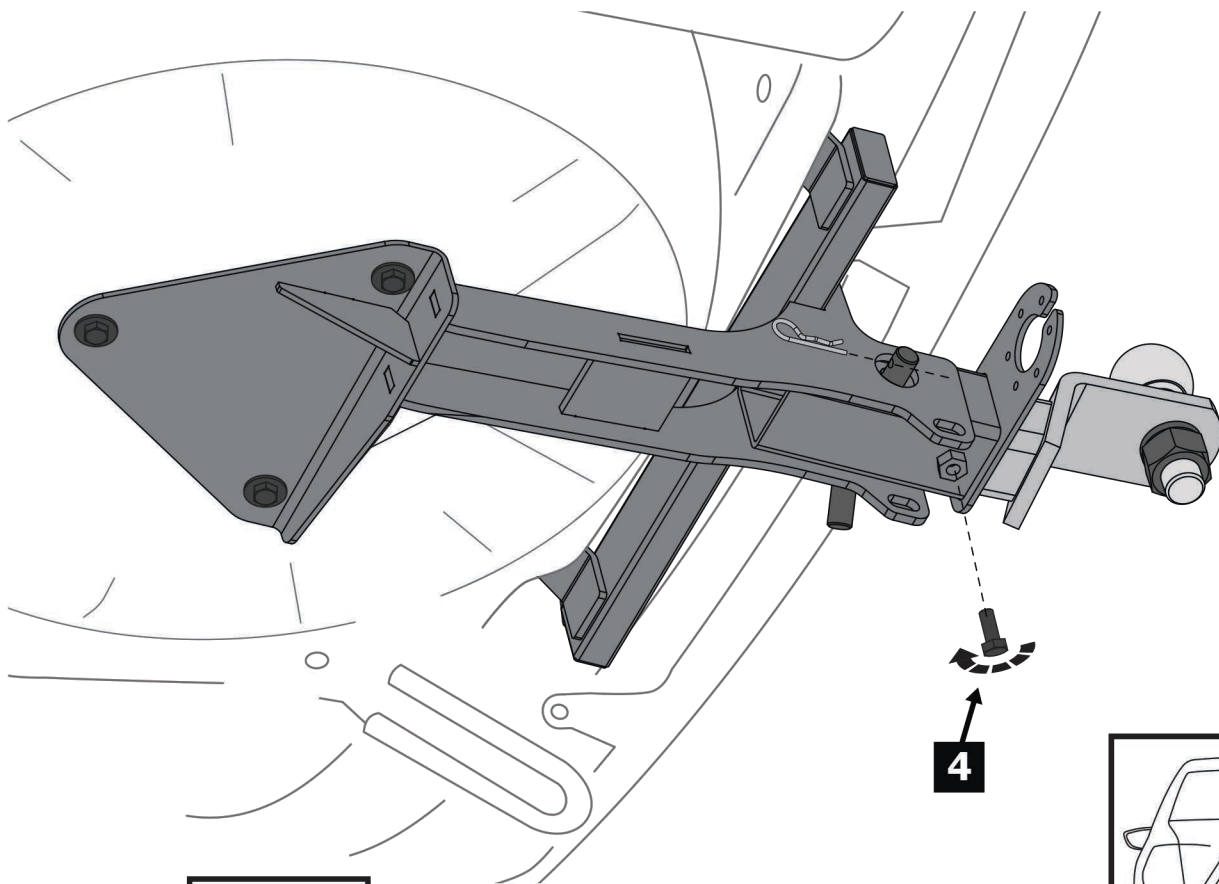
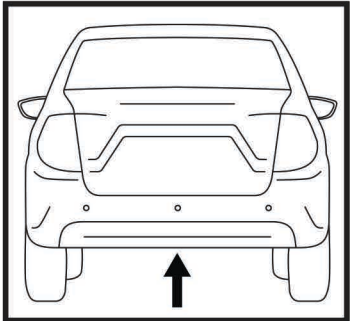

4

6

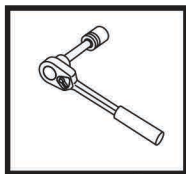

Затянуть все резьбовые соединения
M10 = 47 Nm M12 = 81 Nm

