

- D** Elektroanlage für Anhängervorrichtung Montage- und Betriebsanleitung, Originalbetriebsanleitung
- CZ** Elektrické zařizení pro tažné zařizení Montážní a provozní návod
- DK** Elsæt til anhængertræk Montage- og driftsvejledning
- E** Instalación eléctrica para el dispositivo de remolque Instrucciones de montaje y de servicio
- F** Installation électrique pour dispositif d'attelage Notice de montage et d'utilisation
- FIN** Vetolaitteen sähköjärjestelmä Asennus- ja käyttöohjeet
- GB** Electrical system for trailer hitch Installation and Operating Instructions
- GR** Ηλεκτρικό σύστημα για διάταξη ρυμούλκησης Οδηγίες συναρμολόγησης και λειτουργίας
- HU** Elektromos felszerelés a vonószerkezet Beszerelési utasítás
- I** Impianto elettrico per gancio di traino Istruzioni di montaggio e per l'uso
- N** Elektrisk anlegg for tilhengerfeste Monterings- og bruksanvisning
- NL** Elektrische installaties voor aanhanger Montage- en gebruikshandleiding
- PL** Instalacja elektryczna do haka holowniczego Instrukcja montażu i eksploatacji
- RUS** Электрооборудование для фаркопа Инструкция по монтажу и эксплуатации
- S** Elsystem för dragkrok Monterings- och bruksanvisning

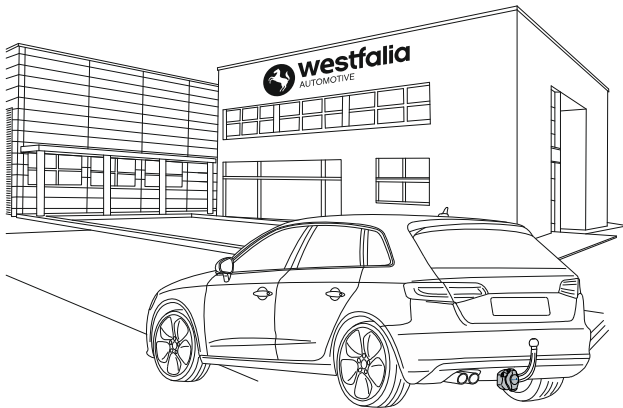

305 408 300 107

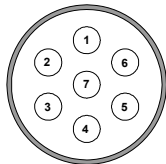

305 408 300 113

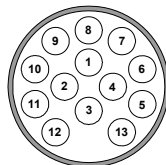

- Audi Q2**, 09/2016 →
- Audi Q3**, 11/2018 →
- Audi Q3 Sportback**, 11/2019 →
- Audi A3 (AB3)**, 06/2014 →
- Audi A3 Sportback (AB3)**, 06/2014 →
- Audi A3 Limousine**, 06/2014 →
- Audi A3 Cabrio**, 06/2014 →
- VW Golf VII**, 06/2014 →
- VW Golf VII Variant**, 06/2014 →
- VW Golf Sportsvan**, 06/2014 →
- VW Touran**, 10/2015 →
- VW Tiguan**, 05/2016 →
- VW Tiguan Allspace**, 09/2017 →
- VW Passat B8 Limousine**, 11/2014 →
- VW Passat B8 Variant**, 11/2014 →
- VW Arteon**, 03/2017 →
- VW T-Roc**, 09/2017 →
- VW T-Roc Cabrio**, 03/2020 →
- Seat Leon III**, 06/2014 →
- Seat Leon ST**, 06/2014 →
- Seat Tarraco**, 02/2019 →
- Seat Ateca**, 07/2016 →
- Cupra Ateca**, 10/2018 →
- Skoda Octavia III**, 06/2014 →
- Skoda Octavia Combi**, 06/2014 →
- Skoda Superb III Limousine**, 06/2015 →
- Skoda Superb III Combi**, 09/2015 →
- Skoda Kodiaq**, 03/2017 →
- Skoda Karoq**, 11/2017 →

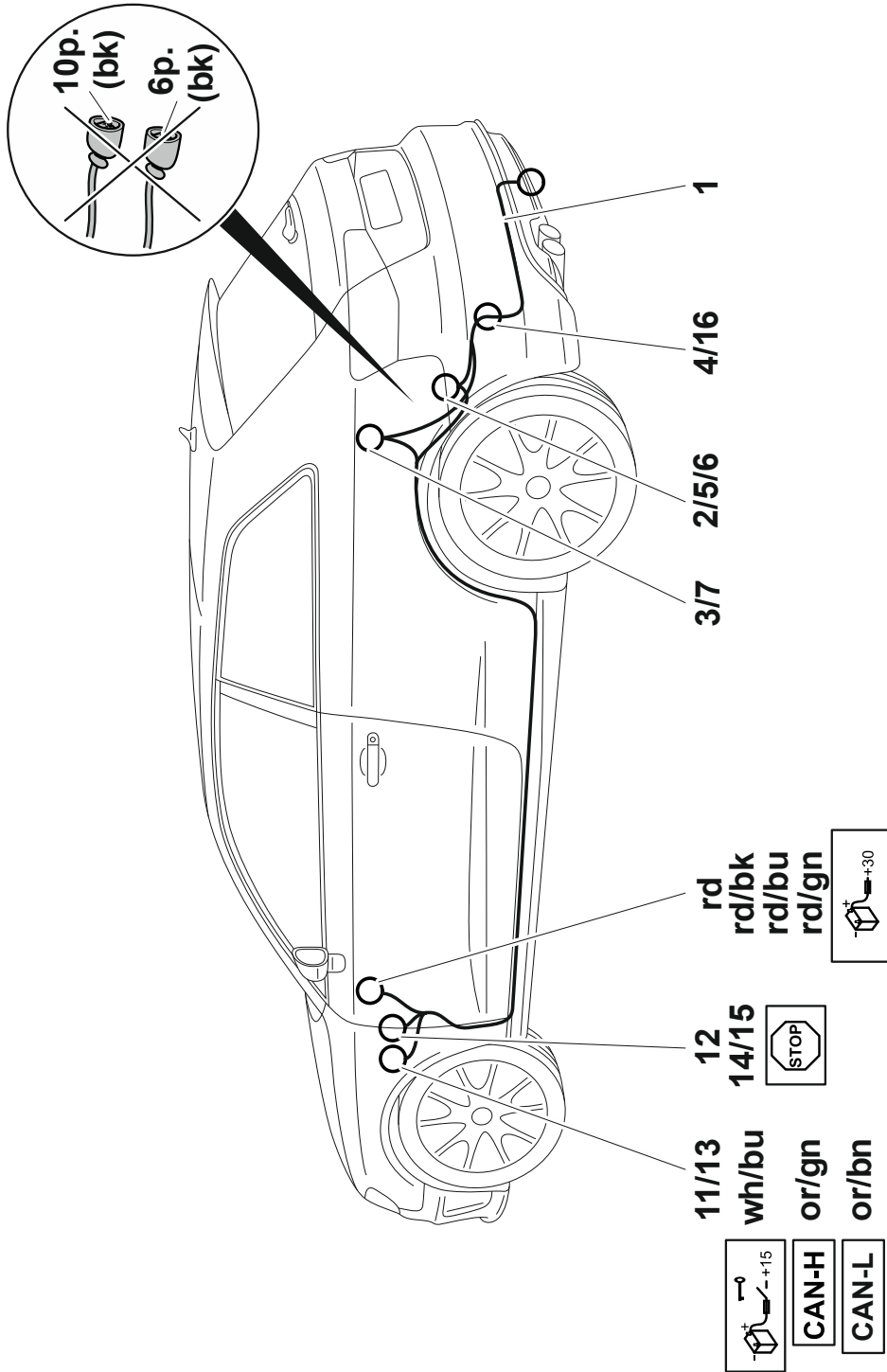

D Steckdosenbelegung

E Esquema de tomas de enchufe

GB Pin assignment

I Schema dei collegamenti della presa

PL Rozkład pinów

CZ Obsazení zásuvky

F Affectation des prises électriques

GR Αντιστοιχία πρίζας

N Kontaktskjema

RUS Разводка розеток

DK Koblingskema

FIN Pistorasian navat

HU Csatlakozódugó leosztása

NL Contactdoosbezetting

S Stickdoschema

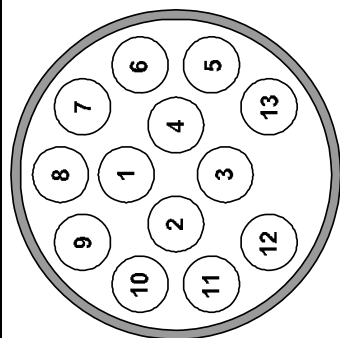



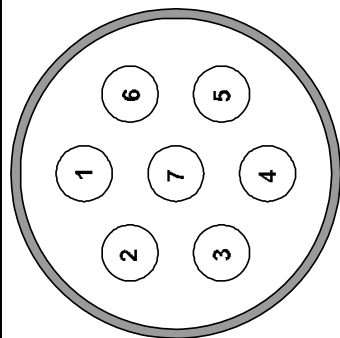











ISO 11446



12N ISO1724

	Leistung / Power	D	CZ	DK	E	F	FIN	GB	GR	HU	I	N	NL	PL	RUS	S
1 (L)	Min. 5 W Max. 21 W	schwarz/ weiß	černobílá	sort/hvid	negro/ blanco	noir/ blanc	musta/va lkoinen	black/ white	μαύρο/ λευκό	fekete/fe hér	nero/ bianco	svart/ hvit	zwart/ wit	czarno/ biały	черный/ белый	svart/ vit
2 (54g)	Min. 5 W Max. 42 W	grau/ blau	šedo /modrý	grá/bíá	gris /azul	gris / bleu	harmaa /sininen	grey /blue	γκρι /μπλε	szürke /kék	grigio /blu	grá/bíá	grijs /blauw	szaro/ niebieski	серый /голубой	grá/bíá
3 (31)		braun	hnědá	brun	marrón	marron	ruskea	brown	καφέ	barna	marrone	brun	bruin	brązowo	коричне Вый	Brun
4 (R)	Min. 5 W Max. 21 W	schwarz/ grün	černo zelená	sort/grøn	negro/ verde	noir/vert	musta/vi hreá	black/ green	μαύρο/ πράσινο	fekete/zö ld	nero/ verde	svart/ grønn	zwart/ groen	czarno/ zielony	черный/ зеленый	svart/ grön
5 (58R)	Min. 5 W Max. 20 W	grau/rot	šedo červená	grá/rød	gris/rojo	gris/ rouge	harmaa/ punainen	gray/ red	γκρι/ κόκκινο	szürke/pi ros	grigio/ rosso	grá/rød	grijs/ rood	szaro/ czerwon	серый/к расный	grá/ röd
6 (54)	Min. 5 W Max. 42 W	schwarz/ rot	černo červená	sort/rød	negro/ rojo	noir/ rouge	musta/pu nainen	black/ red	μαύρο/ κόκκινο	fekete/pir os	nero/ rosso	svart/ rød	zwart/ rood	czarno/ czerwon	черный/ красный	svart/ röd
7 (58L)	Min. 5 W Max. 20 W	grau/ schwarz	šedočern á	grá/sort	gris/ negro	gris/ noir	harmaa/ musta	gray/ black	γκρι/ μαύρο	szürke/fe kete	grigio/ nero	grá/ svart	grijs/ zwart	szaro/ czarny	серый/ч ерный	grá/ svart
8	Min. 5 W Max. 42 W	schwarz/ blau	Černo/ modrý	Sort/ blá	Negro/ azul	Noir/ bleu	Musta/ sininen	Black/ blue	Μαύρο/ μπλε	Fekete/ kék	Nero/ blu	Svart/ blá	Zwart/ blauw	Czarno/ niebieski	Черный/ голубой	Svart/ blá
9 (+30)		rot	červená	rød	rojo	rouge	punainen	red	κόκκινο	piros	rosso	rød	rood	czerwon	красный	röd
10 (+15)		gelb	žlutá	gul	amarillo	jaune	keltainen	yellow	κίτρινο	sárga	giallo	gul	geel	żółty	желтый	gul
11 (31)		braun/ weiß	hnědobílá	brun/hvid	marrón/ blanco	marron/ blanc	ruskea/v alkoinen	brown/ white	καφέ/ λευκό	barna/fe hér	marrone/ bianco	brun/hvit	bruin/ wit	brązowo/ biały	коричне Вый/бел ый	brun/ vit
12																--
13 (31)		braun	hnědá	brun	marrón	marron	ruskea	brown	καφέ	barna	marrone	brun	bruin	brązowo	коричне Вый	brun

	dark	light	bk	wh	bn	gn	gy	rd	ye	bu	or	pu	pi
D	dunkel	hell	schwarz	weiß	braun	grün	grau	rot	gelb	blau	orange	violett	rosa
CZ	tmový	bystrý	černo	bílá	hnědá	zelená	šedo	červená	žlutá	modrý	oranžový	fialový	růžová
DK	mørk	lyse	sort	hvid	brun	grøn	grå	rød	gul	blå	orange	violet	rosa
E	oscuro	claro	negro	blanco	marrón	verde	gris	rojo	amarillo	azul	anaranja-do	violeta	rosa
F	foncé	clair	noir	blanc	marron	vert	gris	rouge	jaune	bleu	orange	violet	rose
FIN	tumma	kirkas	musta	valkoinen	ruskea	vihreä	harmaa	punainen	keltainen	sininen	oranssi	violetti	rosa
GB	dark	light	black	white	brown	green	grey	red	yellow	blue	orange	purple	pink
GR	σκούρο	φωτεινό	μαύρο	λευκό	καφέ	πράσινο	γκρι	κόκκινο	κίτρινο	μπλε	πορτοκαλί	Μωβ	ροζ
H	sötét	fényes	fekete	fehér	barna	zöld	szürke	piros	sárga	kék	narancssárga	ibolyakék	rózsaszín
I	scuro	luminoso	nero	bianco	marrone	verde	grigio	rosso	giallo	blu	arancione	viola	rosa
N	mørk	lyse	svart	hvit	brun	grønn	grå	rød	gul	blå	oransje	fiolett	rosa
NL	donkere	heldere	zwart	wit	bruin	groen	grijs	rood	geel	blauw	oranje	violet	rosé
PL	ciemny	jasno	czarno	biały	brązowo	zielony	szaro	czerny	żółty	niebieski	pomarańczowe	fioletowe	różowa
RUS	темно	светло	черный	белый	коричневый	зеленый	серый	красный	желтый	голубой	оранжевый	пурпурный	розовый
S	mörk	ljus	svart	vit	brun	grön	grå	röd	gul	blå	orange	violett	rosa

																																																																																																																																																																																																																																																																																																																																																																										
---	---	---	---	---	---	---	---	---	---	---	---	---	---	---	---	---	---	---	---	---	---	---	---	---	---	---	---	---	---	---	---	---	---	---	---	---	---	---	---	---	---	---	---	---	---	---	---	---	---	---	---	---	---	---	---	---	---	---	---	---	---	---	---	---	---	---	---	---	---	---	---	---	---	---	---	---	---	---	---	---	---	---	---	---	---	---	---	---	---	---	---	---	---	---	---	---	---	---	---	---	---	---	--	--	--	--	--	--	--	--	--	--	--	--	--	--	--	--	--	--	--	--	--	--	--	--	--	--	--	--	--	--	--	--	--	--	--	--	--	--	--	--	--	--	--	--	--	--	--	--	--	--	--	--	--	--	--	--	--	--	--	--	--	--	--	--	--	--	--	--	--	--	--	--	--	--	--	--	--	--	--	--	--	--	--	--	--	--	--	--	--	--	--	--	--	--	--	--	--	--	--	--	--	--	--	--	--	--	--	--	--	--	--	--	--	--	--	--	--	--	--	--	--	--	--	--	--	--	--	--	--	--	--	--	--	--	--	--	--	--	--	--	--	--	--	--	--	--	--	--	--	--	--	--	--	--	--	--	--	--	--	--	--	--	--	--	--	--	--	--	--	--	--	--	--	--	--	--	--	--	--	--	--	--	--	--	--	--	--	--	--	--	--	--	--	--	--	--	--	--	--	--	--	--	--	--	--	--	--	--	--	--	--	--	--	--	--	--	--	--	--	--	--	--	--	--	--	--	--	--	--	--	--	--	--	--	--	--	--	--	--	--	--	--	--	--	--	--	--	--	--	--	--	--	--	--	--	--	--	--	--	--

	S	Cigarettanda re, 12 V uttag	RUS	Прикуриватель, розетка 12 В	PL	Zapalniczka, gniazdko 12V	NL	Sigarettenaansteker, 12V stopcontact	N	Sigarettenne r, 12 V stikkontakt	I	Accendisigari, presa da 12 V	HU	szivargyújtó, 12V-os dugalj	GR	Αναπτήρας, τριπόδι 12V	GB	cigarette lighter, 12V socket	FIN	Savukkeensytytin, 12V-pistoke	F	Prise allume-cigares 12V	E	Encendedor de cigarrillos, enchufe de 12V	DK	Cigaret tænder, 12V stikkåse	CZ	Zapalovač, 12V zásuvka	D	Zigarettenanzünder, 12V Steckdose	
		Fordon test/programeringsdon		Устройство тестирования программы автомобиля		Test pojazdu/luz. program.		Voertuig-test/programmeer-apparaat		Kjøretøy test/programmeringsenheter		Dispositivo di test/programmazione veicolo		járműteszt/programozó készülék		Συσκευή δοκιμής/πρωτ. οχήματος		vehicle testing/programming equipment		Ajoneuvo-testi/ohjelmointilaitte		Appareil de programmation automatique du véhicule		Aparato de prueba/programación de vehículo		Køretøj test/programmeringsenhed		Test vozidla / programova cí zařizení		Fahrzeug test/programmiergerät	
		Funktion kabel/färg mät upp/jämför		Измерить / сравнить функцию окраски кабеля		Funkcja pomiaru/por. kolorów kabli		Funcție cabeleur/ultrămen / vergelijken		Måle / sammenligne funksjon kabel/farge		Misurare / confrontare funtzione colore cavo		kábelszính mérési / összehasonlítósi funkció		Λειτουργία μέτρησης/ σύγκρισης χρώματος καλωδίου		measure / compare function cable colour		Kaapelivärin toiminto, mittaa ja vertaa		Mesurer/couler de câble de fonction.		Función Medir/color par color de cable		Funktion kabel/farve ud mål/ sammenligne		Zjistit/porovnat barvu kabelu		Funktion kabel/farbe ausmessen / vergleichen	
		Notera avvikande kabel/färg		Записать отклонение окраски кабеля		zauważać różniące się kolory		Afwijkende kabelkleur noteren		noter avvikende kabel/farge		Annotare colore cavo divergente		eltérő kábelszính feljegyzése		Επισημάνση απόκλισης χρώματος καλωδίου		note different cable colours		Merkitse poikkeava kaapeliväri muistiin		Noter différence de couleur câble		Anotar color de cable diferente		Noter afvigende kabel/farve		Zaznamena t odlišnou barvu kabelu		abweichende Kabel/farbe notieren	
		Trådlös nyckel/avläg snä chipcard 10 m från fordonet		Радиоключ / использовать чип-карту на расстоянии 10 м от автомобиля		Klucz zdalny/karta chipowa odległość pojazdu maks. 10 m!		Draadloze sleutel / Chipcard 10m van het voertuig verwijderen!		Radio-nøkkel / Chipcard 10 m unna kjøretøyet		Allontanare a 10 m dal colore la chiave con telecomando / la scheda chip!		A rádiófrekvenciás távirányító a járműben legyen/nem csipkártyát a járműnél 10m-re eltávolítani!		Απομακρύνετε το κλειδί της τηλεχειρ. ού. / την κάρτα chip 10 m από το όχημα!		remove remote key / chipcard to 10m away from the vehicle		Vie radiovaain / sirukortti / chipcard 10 m päähan ajoneuvosta		Eloigner de 10 m du véhicule la clé de radiocommande		Alejar llave inalámbrica / Chipcard 10m del vehículo!		Trådløs nøgle / chipcard 10 m væk fra køretøjet!		Vzdálit se s dálkovým ovládním nebo čipovou kartou 10 m od vozidla		Funktion schlüssel / chipcard 10m vom Fahrzeug entfernen!	
		Taster im Fahrzeug vorhanden ja / nej		Контактный щуп в автомобиле да / нет		Przyścis dostępny w pojeździe tak / nie		Knop in het voertuig aanwezig ja / neen		Knapp finnes i kjøretøyet ja / nei		Tasto presente nel veicolo sì / no		Nyomógomb a járműben igen/nem		Υπάρχει πλήκτρο στο όχημα ναι/όχι		switch available in vehicle yes / no		Painike ajoneuvossa kyllä/ei		Touche dans le véhicule oui / non		Existe pulsador en el vehículo sí / no		Finder der en knap i køretøjet ja / nej		Tlačítko je/není k dispozici ve vozidle		Taster im Fahrzeug vorhanden ja / nein	
		Anslut		Соединить		połączyć		Verbinden		koble til		collegare		összekapcsolás		Σύνδεση		connect		yhdistä		connecter		unir		tilslut		Spojít		verbinden	
		Frånskill		Разделить		rozłączyć		Onderbreken		koble fra		scollegare		szétválasztás		Αποσύνδεση		disconnect		erota		séparer		separar		adskil		Rozpojit		trennen	
		Signalgivare		Датчики сигналов		Nadajnik sygnatu		Signaalgever		Signalgiver		Indicatore di segnale		jeladó		Κοδικόσημα της σήμανσης		signal transmitter		Merkintö-laitte		Avertisseur		Emisor de señales		Signalgiver		Upozornění		Signalgeber	
		Observera/id entifiera		Следить / заметить		uwzględnić/rozpoznać		Opmerken / herkennen		overhold / registrer		rispettare / riconoscere		figyelembe venni / felismerni		Προσοχή / αναγνώριση		observe / recognize		huomaa / tunnista		observer / identifier		observar / reconocer		bemærk / registrere		Prohédnout /zhodnotit		beachten / erkennen	
		Signál släp/vagn identifierad		Сигнал прицепа распознан		Signal przycepy rozpoznany		Signaal aanhangwagen herkend		Signal tilhenger registrert		Segnale rimorchio riconosciuto		Ulfánutó jel felismerve		Αναγνώριση σήματος ρυμουγκου έσου		trailer signal recognized		Perävaunun signaali tunnistettu		Signal remorque identifié		Señal remolque detectada		Signal anhänger registreret		Rozpoznání signálu přívěsu		Signal Anhänger erkannt	

D

Nationale Richtlinien über die Anbauabnahmen sind zu beachten.

Jegliche Änderungen bzw. Umbauten an der Elektroanlage sind verboten. Sie führen zum Erlöschen der Betriebserlaubnis. Vor Arbeitsbeginn die Einbauanleitung lesen.

Wichtig: Prüfen Sie den Inhalt des Sets, bevor Sie mit der Installation beginnen und melden Sie gegebenenfalls Abweichungen. Beginnen Sie erst mit der Installation, wenn Sie über ein vollständiges Set verfügen.

Die Elektroanlage für Anhängervorrichtung darf nur von Fachunternehmen montiert werden. Bei falscher Montage besteht schwere Unfallgefahr!

Westfalia-Automotive haftet nicht für Personen- oder Sachschäden beziehungsweise Verluste, die durch die Installation oder eine fehlerhafte Montage oder Nutzung des Produkts verursacht werden.

Arbeiten an Airbags dürfen nur von entsprechend geschultem Personal durchgeführt werden.

Achtung – vor Arbeitsbeginn den Fehlerspeicher auslesen, ggf. Ruhestrom-Erhaltungsgerät verwenden, ansonsten können elektronisch gespeicherten Daten verloren gehen. Batterie abklemmen, um Beschädigungen der KFZ- Elektronik zu vermeiden.

Wichtiger Hinweis: Das Anhängermodul ist diagnosefähig. Wenn die Diagnoseprozesse des Herstellers oder softwareunterstützte Testmechanismen Fehlerberichte erzeugen, die direkt oder indirekt mit dem Betrieb des Anhängers in Zusammenhang stehen, muss das Anhängermodul vom Leitungsstrang des Anhänger Leitungssatzes getrennt werden und ein neuer Diagnoseprozess gestartet werden.

Für technische Änderungen, Software updates, die nach Erst- Inbetriebnahme z.B. durch den Fahrzeughersteller durchgeführt werden und zu Fehlfunktionen bei Anhängerbetrieb führen, kann keine Gewährleistung übernommen werden.

Leitungen dürfen weder eingeklemmt noch beschädigt sein. Alle Dichtungselemente ordnungsgemäß anbringen.

Bei Anhängerbetrieb wird die Nebelschlussleuchte des Zugfahrzeugs abgeschaltet.

Ein Steckdosenadapter darf nur im Anhängerbetrieb genutzt werden.

- Der Ausfall der Anhängerblinkleuchten wird durch die Erhöhung der Blinkfrequenz im Cockpit angezeigt.
- Durch eine zusätzliche Kontrollleuchte im Cockpit wird die Blinkfunktion am Anhänger angezeigt, ggf. Codierung erforderlich
- Der Ausfall der Anhängerblinkleuchten wird durch eine Kontrollleuchte (einen Signalgeber) im Cockpit angezeigt, ggf. Codierung erforderlich.

Die Prüfung der Anhängerfunktionen mit einem Anhänger oder einem Prüfgerät mit Belastungswiderständen durchführen.

Achtung! Es ist sicherzustellen das alle Anforderungen des Fahrzeughersteller zu Änderungen und Nachrüstungen am Fahrzeug und/oder Kühlsystem für den Betrieb mit Anhänger durchgeführt wurden.

Der deutsche Text dieser Anleitung ist bindend.

Änderungen vorbehalten.

CZ

Je nutné dodržovat místní směrnice o demontáži nástaveb.

Veškeré změny příp. přestavby elektrického zařízení jsou zakázány. Mají za následek zánik platnosti povolení k provozu.

Před zahájením práce si prostudujte návod k montáži.

Důležité: Před montáží zkontrolujte obsah soupravy a nahláste případné odlišnosti. S montáží začněte pouze v případě, že máte k dispozici kompletní soupravu.

Elektrické zařízení pro tažné zařízení smí montovat pouze odborné podniky. Při chybné montáži hrozí vážné nebezpečí nehody! Společnost Westfalia-Automotive není zodpovědná za případná zranění, škody na majetku nebo ztráty na zisku, které mohou být způsobeny chybnou montáží nebo nesprávném používáním výrobku.

Práce na airbagů by měl provádět pouze řádně vyškolení pracovníci.

Pozor – před zahájením práce načtěte paměť chyb, popř. použijte zařízení pro udržení klidového proudu, jinak můžete ztratit elektronicky uložená data. Odpojte akumulátorovou baterii, aby nedošlo k poškození elektronické soustavy vozidla.

Důležitá poznámka: Na jednotce přívěsu je možné provádět diagnostiku. Pokud diagnostika výrobce nebo softwarové testy vykazují chybové hlášky, které přímo či nepřímo souvisí s provozem přívěsu, je nutné odpojit kabely jednotky přívěsu ze zásuvky a spustit novou diagnostiku.

Neneseme žádnou zodpovědnost za technické změny a aktualizace softwaru provedené po prvním uvedení do provozu (např. výrobcem vozidla), které mohou způsobit nesprávnou funkci přívěsu.

Vodiče nesmí být sevřené ani poškozené. Všechny těsnicí prvky náležitě namontujte.

Při provozu s tažným zařízením se vypne koncové světlo do mlhy na tažném vozidle.

Adaptér zásuvky se smí používat jen při provozu s přívěsem.

- Výpadek směrových světel přívěsu je indikován ve vozidle zvýšenou frekvencí blikání.
- Přídavnou kontrolkou ve vozidle je indikována funkce blikání přívěsu, příp. je nutné kódování.
- Výpadek směrových světel přívěsu je indikován ve vozidle kontrolkou (signalizačním zařízením), příp. je nutné kódování.

Kontrolu funkcí přívěsu provádějte pomocí přívěsu nebo vhodného kontrolního přístroje se zatěžovacími odpory.

Pozor! Ujistěte se, zda jsou splněny všechny podmínky provozu přívěsu stanovené výrobcem vozidla a zda byly provedeny všechny úpravy a dodatečné vybavení vozidla či chladicího systému.

Německý text tohoto návodu je závazný.

Změny vyhrazeny.

De nationale direktiver for montering af tilbehør skal overholdes.

Enhver ændring eller ombygning på el-anlægget er forbudt. Dette medfører, at typegodkendelsen ikke er gældende. Læs monteringsvejledningen inden påbegyndelse af arbejdet.

Vigtigt: Kontrollér sættets indhold inden du begynder med installationen og meddel i givet fald afvigelser. Begynd først installationen, når du har et komplet sæt.

Elsættet til anhængertrækket må kun monteres af kvalificeret personel. Ved forkert montering er der fare for alvorlige fejlfunktioner!

Westfalia-Automotive overtaget ikke ansvaret for person- eller tingskader henholdsvis for tab, der er forårsaget af en forkert installation, montage eller anvendelse af produktet.

Arbejdet med airbags bør kun udføres af dertil uddannet personale.

Bemærk – udlæs fejlloggen inden påbegyndelse af arbejdet, anvend evt. apparat til opretholdelse af hvilestrøm, ellers kan elektronisk lagrede data gå tabt. Frakobl batteriet for at undgå beskadigelse af personbilens elektronik.

Vigtig information: Anhængermodul er diagnosekompatibelt. Hvis producentens diagnoseprocesser eller softwareunderstøttede testmekanismer genererer fejlrapporter, som hænger direkte eller indirekte sammen med anhængerens drift, skal anhængermodul adskilles fra kablerne til anhængerbøsningen og der skal startes en ny diagnoseproces.

For tekniske ændringer, software-updates, der gennemføres efter den første ibrugtagning, f.eks. af køretøjsproducenten og som medfører fejlfunktioner i anhængerdriften, kan der ikke overtages noget ansvar.

Ledningerne må ikke hverken blive klemt eller beskadiget. Alle tætningselementerne skal anbringes efter forskrifterne.

Ved brug af anhængerens elstik frakobles trækkøretøjets tågebaglygte.

En stikdåseadapter må udelukkende anvendes ved drift med anhængerens.

- Svigt af anhængerens blinklys vises via en forhøjet blinkfrekvens i instrumentpanelet.
- Blinkefunktionen på anhængerens vises via et yderligere kontrollys i instrumentpanelet, kodning er evt. nødvendig
- Svigt af anhængerblinklysene vises via et kontrollys (en signalgiver) i instrumentpanelet, kodning er evt. nødvendig.

Kontrol af anhængerfunktionerne skal foretages med en anhænger eller et kontrolapparat med belastningsmodstand.

OBS! Kontrollér, at alle køretøjsproducentens krav til ændringer og eftermonteringer på køretøj og/eller kølesystem til brug med anhænger er blevet gennemført.

Den tyske tekst i denne vejledning er bindende.

Ret til ændringer forbeholdes.

Deben respetarse las directivas nacionales referentes a controles de enganches.

Está prohibido modificar o remodelar la instalación eléctrica. La consecuencia sería la invalidación del permiso de circulación. Antes de iniciar la tarea, lea las instrucciones de montaje.

Importante: Verifique el contenido del juego antes de comenzar con la instalación y notifique las diferencias si las hubiera. Comience con la instalación recién cuando disponga de un juego completo.

La instalación eléctrica para el dispositivo de remolque sólo debe montarla personal cualificado. ¡En caso de montaje erróneo existe peligro de accidentes graves!

Westfalia-Automotive no asume ninguna responsabilidad por daños personales o materiales, respectivamente pérdidas, que sean causados por la instalación o por un montaje o uso del producto deficientes.

Trabajo sobre las bolsas de aire sólo debe ser realizada por personal debidamente capacitado.

Atención – antes de iniciar la tarea, leer la memoria de fallos, si es necesario utilizar un dispositivo de mantenimiento de corriente de reposo, de lo contrario podría perder los datos memorizados electrónicamente. Desconecte la batería para evitar daños en la instalación eléctrica del vehículo.

Nota importante: El módulo de remolque posee capacidad de diagnóstico. Si los procesos de diagnóstico del fabricante o mecanismos de prueba soportados por software generan informes de falla, que están relacionados directa o indirectamente con la operación del remolque, se debe desconectar el módulo de remolque de los cables que llevan al terminal de enchufe del remolque y se debe iniciar un nuevo proceso de diagnóstico.

No puede asumirse ninguna garantía por modificaciones técnicas o actualizaciones de software que hayan sido realizadas después de la primera puesta en servicio, p. ej. por el fabricante del vehículo, y que causen funcionamientos defectuosos en la operación del remolque.

Se debe evitar dañar o aprisionar los cables. Instalar correctamente todas las juntas.

Al circular con remolque se desconecta la luz antiniebla trasera del vehículo de tiro.

Sólo se puede usar un adaptador de caja de enchufe cuando se circule con remolque.

- Un error de los intermitentes del remolque se indicará aumentando la frecuencia de parpadeo en el cuadro de mando.
- Mediante un chivato luminoso adicional en el cuadro de mandos se señala el funcionamiento de los intermitentes del remolque (puede requerir codificación)
- Un error de los intermitentes del remolque se indicará mediante un chivato luminoso (emisor) en el cuadro de mando (puede requerir codificación).

La comprobación de las funciones del remolque debe efectuarse con un remolque o bien con un equipo de comprobación con resistores reguladores de carga.

¡Atención! Se debe asegurar que se ha cumplido con todos los requerimientos del fabricante del vehículo en lo que respecta a modificaciones y reequipamiento en el vehículo y/o sistema de refrigeración para la operación con remolque.

Es vinculante el texto alemán de estas instrucciones.

Nos reservamos el derecho a efectuar modificaciones.

Les dispositions nationales concernant la réception à titre isolé doivent être respectées.

Toute modification ou transformation de l'installation électrique est interdite. Elle entraînerait l'annulation de la réception.

Lire impérativement la notice de montage avant de commencer le travail.

Important : Vérifier le contenu de l'ensemble avant de commencer l'installation et mentionner le cas échéant les anomalies. Ne commencer l'installation que lorsque vous disposez d'un ensemble complet.

Seules des entreprises spécialisées sont autorisées à monter le faisceau électrique du dispositif d'attelage. Un montage incorrect représente un risque élevé d'accident !

Westfalia-Automotive n'est pas tenu responsable des dommages aux personnes ou matériels ou bien de pertes qui seraient causés par l'installation ou un montage défectueux ou une mauvaise utilisation du produit.

Travail sur les airbags ne doivent être effectuées que par du personnel formé.

Attention – Avant de commencer le travail, éliminer l'ensemble des défauts présents dans la mémoire de l'ordinateur de bord ou utiliser un générateur de courant de veille pour éviter que des données enregistrées sur support électroniques ne soient perdues. Débrancher la batterie afin d'éviter tout endommagement de l'installation électronique du véhicule.

Information importante : Le module de remorque peut faire l'objet d'un diagnostic. Si les procédures de diagnostic du fabricant ou les mécanismes de contrôle informatisés produisent des rapports de défauts en rapport direct ou indirect avec l'utilisation de la remorque, le module de remorque doit être séparé des câbles allant à la prise de remorque et une nouvelle procédure de diagnostic doit être lancée.

Aucune garantie ne peut être prise en charge eu égard aux modifications techniques, aux mises à jours de logiciel qui sont effectuées après la première mise en marche, par ex. : par le fabricant du véhicule et qui conduisent à des fonctionnements défectueux de la remorque.

Les fils électriques ne doivent être ni endommagés ni coincés. Mettre en place tous les éléments d'étanchéité conformément à la notice.

Lorsqu'une remorque/caravane est attelée, le fonctionnement du feu de brouillard arrière du véhicule tracteur est interrompu.

Un adaptateur pour prise de courant ne doit être utilisé que si une remorque/caravane est tractée.

- a) Une panne des clignotants de la remorque/caravane est signalée par l'augmentation de la fréquence de clignotement dans l'habitacle.
- b) Un voyant supplémentaire situé dans l'habitacle contrôle le bon fonctionnement des clignotants sur la remorque, un codage (valise constructeur) peut être nécessaire.
- c) Une panne des clignotants de la remorque/caravane est signalée via un voyant (transmetteur de signal) situé dans l'habitacle, un codage (valise constructeur) peut être nécessaire.

Le contrôle des fonctions de l'attelage doit s'effectuer avec une remorque ou avec un appareil de contrôle muni d'ampoules classiques.

Attention ! Il convient de s'assurer que toutes les consignes imposées du fabricant du véhicule ont été respectées concernant les modifications et les équipements ultérieurs réalisés sur le véhicule et/ou le système de refroidissement pour l'utilisation avec la remorque.

Le texte allemand de cette notice fait foi.

Sous réserve de modifications.

Kansallisia suuntaviivoja, mitä tulee asennukseen, on noudatettava.

Kaikki sähköjärjestelmään tehtävät muutokset tai jälkiasennukset ovat kiellettyjä. Nämä johtavat käyttöluvan raukeamiseen.

Lue asennusohjeet ennen työskentelyn aloittamista.

Tärkeää: Tarkasta sarjan sisältö, ennen kuin aloitat asennuksen ja ilmoita mahdollisista poikkeamista. Aloita asennus vasta, kun olet varma, että sarja on täydellinen.

Vetolaitteen sähköjärjestelmän saa asentaa vain alan erikoisliike. Virheellinen asennus voi aiheuttaa vakavan onnettomuuden!

Westfalia-Automotive ei vastaa henkilö- tai esinevahingoista tai muistakaan vahingoista, jotka ovat seurausta tuotteen virheellisestä asennuksesta tai käytöstä.

Työ turvattuun saa suorittaa vain asianmukaisesti koulutettu henkilöstö.

Huomio: lue vikamuisti ennen työskentelyn aloittamista. Käytä tarvittaessa lepovirran säilymistä varmistavaa laitetta, jotta elektronisesti tallentuneet tiedot eivät katoa muistista. Irrota akun navat, jotta ajoneuvon elektroniikka ei vaurioidu.

Tärkeä ohje: Perävaunumoduuli on diagnoosikykyinen. Jos valmistajan diagnoosiprosessit tai ohjelmistotuetut testimekanismit antavat tulokset virheraportteja, jotka ovat suorassa tai epäsuorassa yhteydessä perävaunun käytön kanssa, on perävaunumoduuli erotettava perävaunuliitännän kaapeleista ja uusi diagnoosiprosessi käynnistettävä.

Valmistaja ei vastaa teknisistä muutoksista tai ohjelmistopäivityksistä, jotka toteutetaan ensimmäisen käyttöönoton jälkeen tai ajoneuvon valmistajan toimesta ja joista on seurauksena perävaunun käyttöön virhetoimintoja.

Johdot eivät saa jäädä puristuksiin eivätkä vaurioitua. Kiinnitä kaikki tiiviste-elementit asianmukaisesti.

Vetoajoneuvon takasumuvalot eivät toimi vetolaitteen käytön aikana.

Pistorasia-adapteria saa käyttää ainoastaan perävaunun yhteydessä.

- a) Perävaunun suuntavilkujen toimintahäiriön ilmaisee merkkivalon vilkkumistaajuuden kasvu ohjaamossa.
- b) Perävaunun suuntavilkun toiminnan ilmaisee lisämerkkivalo ohjaamossa. Merkkivalo saattaa vaatia koodausta.
- c) Perävaunun suuntavilkujen toimintahäiriön ilmaisee ohjaamossa oleva merkkivalo (signaalianturi). Merkkivalo saattaa edellyttää koodausta.

Perävaunuun liittyvät toiminnot on testattava joko perävaunun kanssa tai kuormitusvastuksilla varustetulla testauslaitteella.

Huomio! On varmistettava, että kaikkia ajoneuvon valmistajan ajoneuvoon ja/tai jäähdytysjärjestelmään tehtäviin muutoksiin ja jälkivarusteluihin, jotka koskevat perävaunun käyttöä, liittyviä vaatimuksia noudatetaan.

Tämän ohjeen saksankielinen teksti on sitova.

Oikeudet muutoksiin pidätetään.

Observe national guidelines on the approval of accessories.

Any alteration or modification of the electrical system is prohibited and voids the operating licence.

Read the installation manual before beginning to work.

Important: Check contents of kit before commencing installation and report any discrepancies. Do not commence installation unless you have a complete kit.

Only qualified companies may install the electrical system for the trailer hitch. Improper assembly may result in a serious accident hazard!

Westfalia-Automotive is not liable for personal injury, damage or loss caused by the installation or improper assembly or use of the product.

Work on airbags should only be performed by properly trained personnel.

Attention – before starting to work, read out the errors stored in the memory. If required, use a power supply to prevent electronically saved data from being erased. Disconnect the battery to prevent damage to the vehicle electronics.

Important: The trailer module is diagnostic capable. If the manufacturer's diagnostic processes or software supported test mechanisms generate error reports directly or indirectly linked with the trailer operation, the trailer module must be disconnected from the leads to the trailer socket and a new diagnostic process initiated.

No guarantee can be given for the malfunctioning of the trailer operation caused by technical changes, software updates, carried out by the vehicle manufacturer, for example, after the initial commissioning.

Verify that no cables are squeezed or damaged. Properly install all seals.

When towing a trailer, the rear fog light of the pulling vehicle is switched off.

An electrical socket adapter may only be used when towing a trailer.

- a) A failure of the trailer turn signal lamps is indicated by an increased flashing rate of the pilot lamp in the cockpit.
- b) An additional pilot lamp in the cockpit indicates the function of the trailer's turn signal; possibly requires programming.
- c) A failure of the trailer turn signal lamps is indicated by a pilot lamp (indicator) in the cockpit; possibly requires programming.

Check the trailer functions with a trailer or a testing instrument with load resistors.

Warning! It must be ensured that all the requirements of the vehicle manufacturer for changes to and retro-fitting on the vehicle and / or cooling system for the operation with a trailer are carried out.

The German text of this instruction is binding.

Subject to change.

Πρέπει να τηρούνται οι κρατικοί κανονισμοί σχετικά με τον έλεγχο προσθηκών στα αμαξώματα.

Απαγορεύονται οι αλλαγές και οι μετατροπές στην ηλεκτρική εγκατάσταση. Συναπάγονται την ακύρωση της άδειας λειτουργίας.

Πριν από την έναρξη των εργασιών μελετήστε τις οδηγίες τοποθέτησης.

Σημαντικό: Ελέγξτε το περιεχόμενο του σετ προτού αρχίσετε τις εργασίες εγκατάστασης, και αναφέρετε τυχόν αποκλίσεις. Αρχίστε την εγκατάσταση μόνο εφόσον το σετ που διαθέτετε είναι πλήρες.

Το ηλεκτρικό σύστημα για διατάξεις ρυμούλκησης επιτρέπεται να τοποθετείται μόνο από ειδικά συνεργεία. Σε περίπτωση λάθους τοποθέτησης υπάρχει κίνδυνος σοβαρών ατυχημάτων!

Η Westfalia-Automotive δεν φέρει ευθύνη για τραυματισμούς, ζημιές ή απώλειες που προκαλούνται από την εγκατάσταση ή από τυχόν εσφαλμένη τοποθέτηση ή χρήση του προϊόντος.

Οι εργασίες σχετικά με τους αερόσακους θα πρέπει να εκτελείται μόνο από κατάλληλα εκπαιδευμένο προσωπικό.

Προσοχή – Πριν από την έναρξη των εργασιών διαβάστε τη μνήμη σφαλμάτων ή αντίστοιχα χρησιμοποιήστε μία συσκευή διατήρησης ρεύματος. Διαφορετικά μπορεί να χαθούν τα ηλεκτρικά αποθηκευμένα δεδομένα. Αποσυνδέστε την μπαταρία ώστε να αποφευχθούν οι ζημιές στα ηλεκτρονικά του οχήματος.

Σημαντική υπόδειξη: Η μονάδα ρυμουλκούμενου διαθέτει δυνατότητες διάγνωσης. Όταν οι διαγνωστικές διαδικασίες του κατασκευαστή ή οι υποστηριζόμενοι από λογισμικό μηχανισμοί δοκιμής εμφανίζουν αναφορές σφάλματος που σχετίζονται άμεσα ή έμμεσα με τη λειτουργία του ρυμουλκούμενου, η μονάδα ρυμουλκούμενου πρέπει αποσυνδεθεί από τα καλώδια που τη συνδέουν με την υποδοχή σύνδεσης ρυμουλκούμενου και στη συνέχεια να ξεκινήσει μια νέα διαδικασία διάγνωσης.

Για τεχνικές αλλαγές και ενημερώσεις λογισμικού μετά την πρώτη θέση σε λειτουργία που εκτελούνται π.χ. από τον κατασκευαστή του οχήματος και οδηγούν σε σφάλματα λειτουργίας του συστήματος ρυμούλκησης, δεν αναλαμβάνεται ευθύνη.

Τα καλώδια δεν πρέπει ούτε να μαγκώνονται ούτε να είναι χαλασμένα. Τοποθετήστε σωστά όλα τα στοιχεία στεγανοποίησης.

Κατά την οδήγηση με τρέιλερ το πίσω φανάρι ομίχλης του έλκοντος οχήματος απενεργοποιείται.

Ένας προσαρμογέας πρίζας επιτρέπεται να χρησιμοποιηθεί μόνο κατά την οδήγηση με τρέιλερ.

- a) Η τυχόν βλάβη των φώτων της διάταξης ρυμούλκησης εμφανίζεται στο ταμπλό με αύξηση της συχνότητας αναβοσβήσματος.
- b) Με τη βοήθεια μιας πρόσθετης λυχνίας ελέγχου στο ταμπλό εμφανίζεται η λειτουργία αναβοσβήσματος στη ρυμούλκα. Μπορεί να χρειάζεται κωδικοποίηση.
- c) Η βλάβη των φώτων αναβοσβήσματος της ρυμούλκας εμφανίζεται με μία λυχνία ελέγχου (έναν κωδικοποιητή σήματος) στο ταμπλό. Μπορεί να χρειάζεται κωδικοποίηση.

Ο έλεγχος των λειτουργιών της ρυμούλκας πρέπει να γίνεται ή με μία ρυμούλκα ή με μια συσκευή μετρήσεων με αντιστάσεις καταπόνησης.

Προσοχή! Θα πρέπει να διασφαλιστεί ότι έχουν υλοποιηθεί όλες οι απαιτήσεις του κατασκευαστή του οχήματος για μετατροπές και προσθήκες εξοπλισμού στο όχημα ή/και το σύστημα ψύξης, οι οποίες σχετίζονται με τη λειτουργία με ρυμουλκούμενο.

Το γερμανικό κείμενο αυτών των οδηγιών είναι δεσμευτικό.

Διατηρούμε το δικαίωμα αλλαγών.

Figyelembe kell venni a műszaki átvételre vonatkozó nemzeti irányelveket.

Az elektromos felszerelésen tilos bármiféle átalakítást végezni. A szerkezet megváltoztatása vagy átalakítása a forgalmi engedély megszűnését vonja maga után.

A munka megkezdése előtt olvassa el a szerelési útmutatót.

Fontos: A beépítés megkezdése előtt ellenőrizze a garnitúra tartalmát és adott esetben jelentse az eltéréseket. Csak akkor kezdje meg a beépítést, ha teljes garnitúra rendelkezésére áll.

A vonószerkezet elektromos részét csak szaküzem szerelheti be. Helytelen szerelés súlyos balesethez vezethet!

A Westfalia-Automotive nem vállal felelősséget a beépítés vagy hibás szerelés vagy a termék használata által okozott személyi sérülésekért vagy dologi károkért.

Végzett munka légszákok csak akkor kell elvégezni a megfelelően képzett személyzet.

Figyelem– a munka megkezdése előtt olvassa ki a hibatárolót, adott esetben használjon nyugalmi áramot fenntartó készüléket, máskülönben elveszhetnek az elektronikusan tárolt adatok. Kösse le az akkumulátort, hogy megelőzze a gépjármű elektronikájának megrongálódását.

Fontos tájékoztatás: Az utánfutó modul diagnózisképes. Ha a gyártó diagnózis folyamatai vagy szoftverrel támogatott tesztmechanizmusok az utánfutó működésével közvetlenül vagy közvetve összefüggő hibajelentéseket generálnak, akkor az utánfutó modult le kell választani az utánfutó dugaszhüvelyhez menő kábelekről és új diagnózis folyamatot kell indítani.

Az első üzembe helyezés után pl. a járműgyártó által elvégzett és az utánfutó hibás működéséhez vezető műszaki változtatásokért, szoftverfrissítésekért jótállás nem vállalható.

A vezetékek nem lehetnek becsípődve vagy megrongálódva. Minden szigetelő elemet a rendeltetésének megfelelően szereljen.

Utánfutóüzemben ki lesz kapcsolva a vonatójármű hátsó ködlámpája.

Dugóaljzat adaptert csak vonatatóüzemben szabad használni.

- Az utánfutó indexlámpáinak kiesését a műszerfalon a villogás gyorsulása jelzi.
- A műszerfalon egy külön ellenőrzőlámpa jelzi az utánfutó index működését. Adott esetben kódolásra van szükség.
- Az utánfutó indexlámpáinak kiesését a műszerfalon egy ellenőrző lámpa (jeladó) jelzi. Adott esetben kódolásra van szükség.

Ellenőrizze az utánfutó funkciók működését egy utánfutóval vagy egy terhelő ellenállásokkal ellátott ellenőrzőkészülékkel.

Figyelem! Biztosítani kell, hogy a járműgyártónak az utánfutóval történő működtetés érdekében a járművön és/vagy a hűtőrendszeren elvégzendő változtatásokra vonatkozó minden követelménye teljesüljön.

A német szerelési utasítás betartása kötelező.

Változtatások jogát fenntartjuk.

Devono essere osservate le normative nazionali sui collaudi.

È vietato modificare o montare diversamente l'impianto elettrico. Ciò comporta l'annullamento del permesso di circolazione.

Prima di iniziare i lavori, leggere le istruzioni di montaggio.

Importante: Controllare il contenuto del kit, prima di iniziare l'installazione e segnalare eventuali divergenze. Iniziare l'installazione soltanto quando il kit di cui si dispone è completo.

L'impianto elettrico per il gancio di traino deve essere montato solo da personale specializzato. In caso di montaggio errato sussiste il pericolo di incidenti gravi!

Westfalia-Automotive non è responsabile per danni a cose o persone o nello specifico di perdite verificatesi in seguito all'installazione, al montaggio o all'uso difettoso del prodotto.

Il lavoro sul airbag deve essere eseguita solo da personale addestrato.

Attenzione – prima di iniziare i lavori, leggere la memoria errori, se necessario utilizzare un dispositivo di mantenimento della corrente di riposo per non perdere i dati memorizzati. Scollegare la batteria al fine di evitare danni all'impianto elettronico del veicolo.

Informazione importante: Il modulo del rimorchio può essere sottoposto a diagnosi. Se i processi di diagnosi del costruttore o i meccanismi di test su base software evidenziano degli errori, che sono in rapporto diretto o indiretto con l'esercizio del rimorchio, il modulo del rimorchio deve essere scollegato dai cavi che conducono al connettore femmina per il rimorchio e si deve avviare un nuovo processo di diagnosi.

Non si assume responsabilità alcuna per modifiche tecniche e aggiornamenti software che vengono effettuati dopo la prima messa in funzione dal costruttore del veicolo e che possono provocare il funzionamento difettoso del rimorchio.

I cavi non devono essere schiacciati né danneggiati. Installare correttamente gli elementi di tenuta.

Durante il funzionamento con rimorchio la luce antinebbia posteriore della motrice viene spenta.

Utilizzare un adattatore per prese esclusivamente per il funzionamento con rimorchio.

- Un guasto agli indicatori di direzione del rimorchio viene segnalato da una frequenza di lampeggio più veloce sul quadro comandi.
- Un'ulteriore spia luminosa sul quadro comandi segnala il funzionamento degli indicatori di direzione del rimorchio (può richiedere la codifica)
- Un guasto agli indicatori di direzione del rimorchio viene segnalato da una spia di controllo (segnalatore) sul quadro comandi (può richiedere la codifica).

Il controllo delle funzioni del rimorchio deve essere eseguito con un rimorchio o con un apparecchio di controllo con resistenza di carico.

Attenzione! Occorre controllare che vengano rispettati tutti i requisiti del costruttore del veicolo relativi alle modifiche e agli accessori sul veicolo e/o sull'impianto del raffreddamento per l'esercizio del rimorchio.

È vincolante il testo tedesco di queste istruzioni.

Con riserva di modifiche.

Nasjonale retningslinjer om godkjenning av monteringer skal overholdes.

Enhver endring hhv. ombygging av det elektriske anlegget er forbudt. Dette vil ødelegge brukeropplevelsen.

Les montasjeveiledningen før man begynner arbeidet.

Viktig: Kontroller innholdet i settet før du starter installasjonen og meld fra om eventuelle avvik. Start installasjonen først når du har et fullstendig sett.

Det elektriske anlegget til tilhengerfestet må kun monteres av fagbedrift. Det er stor fare for at det kan oppstå ulykker ved feil montering!

Westfalia-Automotive er ikke ansvarlig for personskader eller materielle skader hhv. tap som skyldes installasjon eller feil montering eller bruk av produktet.

Arbeid på kollisjonsputer bør kun utføres av personell med tilstrekkelig opplæring.

OBS – før arbeidet starter må man lese av feilminnet hhv. benytte hvilestrøms-måleapparat for å unngå at elektronisk lagrede data går tapt. Koble fra batteriet for å unngå at kjøretøyelektronikken skades.

Viktig henvisning: Tilhengermodulen kan diagnostiseres. Hvis diagnoseprosessen til produsenten eller programvarestøttede testmekanismer genererer feilrapporter som er direkte eller indirekte knyttet til driften av tilhengeren, må tilhengermodulen kobles fra kablene til tilhengerkontakten og en ny diagnoseprosess på startes.

Det blir ikke gitt noen garanti for tekniske endringer, programvareoppdateringer som utføres etter første igangkjøring f.eks. av kjøretøyprodusenten, og som fører til funksjonsfeil ved bruk av tilhengeren.

Ledninger må verken klemmes fast eller skades. Alle tettningselementer må monteres på plass i riktig posisjon.

Ved bruk av tilhenger blir baklysene til trekkvognen koblet ut.

Stikkontaktadapteret må kun brukes i kombinasjon med tilhenger.

- a) Hvis blinklysene på tilhengeren faller ut, indikeres dette i førerhuset ved at blinkfrekvensen øker.
- b) Blinkfunksjonen til tilhengeren indikeres via en ekstra varsellampe i førerhuset. Koding evt. nødvendig
- c) Hvis blinklysene på tilhengeren faller ut, indikeres dette med en varsellampe i førerhuset (signalgiver). Koding er evt. nødvendig.

Kontrollen av tilhengerfunksjonen foretas med en tilhenger eller et kontrollinstrument med belastningsmotstander.

Obs! Man må forsikre seg om at alle kravene til kjøretøyprodusenten vedrørende endringer og etterutrustninger på kjøretøyet og/eller kjølesystemet ble gjennomført for drift med tilhenger.

Den tyske teksten i denne veiledningen er bindende.

Med forbehold om endringer.

Nationale richtlijnen betreffende de montagegoedkeuring moeten in acht worden genomen.

Elke wijziging van de elektrische installatie is verboden. Wijziging leidt tot verval van de gebruikstoestemming.

Voor montage eerst de inbouwhandleiding lezen.

Belangrijk: controleer de inhoud van de set voor u met de installatie begint en meld eventuele afwijkingen. Begin pas met de installatie wanneer u over een volledige set beschikt.

De elektrische installatie voor aanhanger mag alleen door vakkundig personeel worden gemonteerd. Bij verkeerde montage bestaat ernstig gevaar voor ongevallen!

Westfalia-Automotive kan niet verantwoordelijk worden gesteld voor materiële schade, lichamelijke letsels of voor mogelijk verlies dat door de installatie, foutieve montage of verkeerd gebruik van het product werd veroorzaakt.

Werkzaamheden aan airbags mag alleen worden uitgevoerd door goed opgeleid personeel.

Attentie – voor montage het foutgeheugen aflezen, eventueel ruststroomapparaat gebruiken, anders kunnen elektrisch opgeslagen gegevens verloren gaan. Los de accu klemmen om beschadiging van de voertuigelektroniek te vermijden.

Belangrijk: de aanhangwagenmodule kan worden gediagnosticeerd. Als de diagnoseprocessen van de fabrikant of software-ondersteunde testmechanismen foutmeldingen genereren die rechtstreeks of onrechtstreeks in verband staan met de werking van de aanhangwagen, moet de aanhangwagenmodule van de kabels tot de aanhangwagenbus losgemaakt worden en een nieuw diagnoseproces worden gestart.

Voor technische wijzigingen, software-updates die na de eerste ingebruikneming (bijv. door de fabrikant van het voertuig) worden uitgevoerd en bij het gebruik van de aanhangwagen tot storingen leiden, kan Westfalia niet verantwoordelijk worden gesteld.

Leidingen mogen niet klemmen of beschadigd zijn. Alle afdichtelementen volgens voorschrift aanbrengen.

Bij gebruik van de aanhanger wordt het mistachterlicht van het voertuig uitgeschakeld.

Een contactdoosadapter mag uitsluitend bij het rijden met aanhangwagen worden gebruikt.

- a) Uitvallen van de aanhangerknipperlichten wordt door een verhoogde knipperfrequentie in de het instrumenten paneel aangegeven.
- b) Door een extra controlelamp in de het instrumenten paneel wordt de knipperfunctie op de aanhanger aangegeven, eventueel codering vereist.
- c) Uitvallen van de aanhangerknipperlichten wordt door een controlelamp (een signaalgever) in de cockpit aangegeven, eventueel codering vereist.

De controle van de aanhangerfuncties met een aanhanger of een testapparaat met belastingsweerstand uitvoeren.

Opgelet! Zorg ervoor dat voor de werking met aanhangwagen aan alle eisen van de voertuigfabrikant i.v.m. veranderingen en wijzigingen aan het voertuig en/of koelsysteem werd voldaan.

De Duitse tekst van deze handleiding is bindend.

Wijzigingen voorbehouden.

Proszę przestrzegać krajowych wytycznych dotyczących odbioru technicznego.

Wszelkie zmiany lub przebudowy instalacji elektrycznej są zabronione. Spowodują one utratę ważności świadectwa homologacji. Przed rozpoczęciem pracy należy przeczytać instrukcję montażu.

Ważne: Sprawdzić zawartość zestawu przed rozpoczęciem instalacji i zgłosić ewentualne odchylenia. Rozpocząć instalację jeżeli zestaw jest kompletny.

Instalacja elektryczna do haka holowniczego może zostać zamontowana wyłącznie przez firmę specjalistyczną. W przypadku nieprawidłowego montażu istnieje poważne ryzyko wypadku!

Firma Westfalia-Automotive nie ponosi odpowiedzialności za obrażenia oraz szkody materialne, wzgl. straty spowodowane instalacją lub nieprawidłowym montażem bądź użytkowaniem produktu.

Prace na poduszki powietrzne powinny być wykonywane wyłącznie przez odpowiednio przeszkolony personel.

Uwaga! Przed rozpoczęciem pracy należy sprawdzić pamięć błędów i w razie potrzeby zastosować urządzenie utrzymujące prąd ciągły. W przeciwnym razie może dojść do utraty danych elektronicznych. Odłączyć akumulator w celu uniknięcia uszkodzeń w instalacji elektrycznej pojazdu.

Ważna wskazówka: Moduł przyczepty jest przystosowany do przeprowadzania diagnozy. W przypadku gdy procesy diagnostyczne przeprowadzane przez producenta lub mechanizmy kontrolne wspomagane przez oprogramowanie doprowadzają do generowania protokołów błędów mających związek pośredni lub bezpośredni z trybem przyczepty, z kompletu przewodów gniazda przyczepty odłączyć należy moduł przyczepty, a następnie powtórnie przeprowadzić procedurę diagnostyczną.

Nie przejmuje się żadnej odpowiedzialności z tytułu wprowadzania technicznych zmian i aktualizacji oprogramowania, które zostały dokonane np. przez producenta pojazdu od chwili pierwszego uruchomienia i które generują błędy podczas eksploatacji przyczepty.

Przewody nie mogą być zaciśnięte ani uszkodzone. Prawidłowo zamontować wszystkie elementy uszczelniające.

Podczas holowania przyczepty odłączone jest tylne światło przeciwmgielne.

Adapter gniazda może być używany tylko podczas holowania przyczepty.

- Awaria kierunkowskazów przyczepty sygnalizowana jest na desce rozdzielczej przez szybciej migającą kontrolkę.
- Miganie kierunkowskazów przyczepty sygnalizowane jest przez dodatkową kontrolkę na desce rozdzielczej (może wymagać kodowania).
- Awaria kierunkowskazów przyczepty sygnalizowana jest przez kontrolkę (sygnalizator) na desce rozdzielczej (może wymagać kodowania).

Funkcje przyczepty należy sprawdzić z podłączoną przycycy lub za pomocą przyrządu kontrolnego z opornością obciążenia.

Uwaga! Należy się upewnić, że zostały spełnione wszystkie wymagania producenta pojazdu dotyczące zmian i doposażania pojazdu i/lub systemu chłodzenia w celu eksploatacji z przycycy.

Tekst niniejszej instrukcji w języku niemieckim jest wiążący.

Zmiany zastrzeżone.

Подлежат соблюдение национальные директивы о порядке приемки навесного/встраиваемого оборудования.

Какие-либо изменения и переделки на электрооборудовании недопустимы. Они делают недействительным разрешение на эксплуатацию.

Перед началом работы прочтите инструкцию по монтажу.

Важно: Проверить содержимое набора перед началом установки и сообщить в случае отклонений. Начинать установку только при наличии полного набора.

К монтажу электрооборудованию сцепного устройства допускаются только специализированные фирмы. При неправильном монтаже грозит опасность тяжелых травм!

Westfalia-Automotive не несет ответственности за ущерб, причиненный людям или имуществу, и соотв. за убытки, причиной которых стали ошибки при установке, монтаже или использовании продукта.

Работа над подушками безопасности должны выполняться только надлежащим образом обученным персоналом.

Внимание – перед началом работы прочтите содержимое накопителя сбоев, при необходимости воспользоваться источником бесперебойного питания во избежание потери сохраненных данных в электронных устройствах. Отсоединить батарею, чтобы предотвратить повреждение электроники автомобиля.

Важное указание: Модуль прицепа имеет функцию диагностики. Если в ходе процессов диагностики производителя или при использовании программных тестовых механизмов составляются протоколы ошибок, которые прямо или косвенно связаны с эксплуатацией прицепа, модуль прицепа необходимо отсоединить от кабелей блока прицепа и запустить новый процесс диагностики.

Гарантийные претензии не принимаются в случае технических изменений, обновлений ПО, которые были произведены после первичной приёмки в эксплуатацию, например, производителем автомобиля и привели к неправильной работе прицепа.

Не допускать заземления и повреждения электропроводки. Все уплотнения устанавливать как положено.

При использовании прицепом отключать на тягаче заднюю противотуманную фару.

Пользоваться розеточным переходником только при работе с прицепом.

- Отказ мигалок прицепа отображается в кабине учащенным миганием.
- Дополнительная контрольная лампочка на пульте салона отображает работу мигалок на прицепе; если нужно, использовать кодирование.
- Отказ мигалок прицепа отображается на пульте в кабине сигнальной лампочкой (сигнализатором) мигалок на прицепе; если нужно, использовать кодирование.

Проверку работы прицепа вести с самим прицепом или пробником с нагрузочными сопротивлениями.

Внимание! Необходимо удостовериться, что выполнены все требования производителя автомобиля по изменениям и дополнительному оснащению автомобиля и/или системы охлаждения для эксплуатации с прицепом.

Обязательным является немецкий текст данной инструкции.

Право на внесение изменений сохраняется.

Nationella riktlinjer beträffande monteringen skall beaktas.

All form av ändring respektive ombyggnad på elsystemet är förbjuden. Förändringar resulterar i att körtillståndet upphör att gälla. Läs igenom monteringsanvisningarna innan arbetet påbörjas.

Viktigt: Kontrollera setets innehåll innan du börjar med installationen och rapportera i förekommande fall avvikelser. Börja med installationen först när du har ett komplett set.

Elsystemet för dragkroken får endast monteras av kvalificerade tekniker. Vid felaktig montering föreligger risk för allvarliga olyckor!

Westfalia-Automotive tar inte ansvar för personskador eller materiella skador resp. förluster, som förorsakats av installationen eller en felaktig montering eller användning av produkten.

Arbete på krockkuddar bör endast utföras av utbildad personal.

Obs – innan arbetet påbörjas, läs av felminnet och använd vid behov enheten för bibehållning av vilostrom, annars kan elektroniskt sparade data gå förlorade. Frånkoppla batteriet för att undvika skador på fordonselektroniken.

Viktigt anvisning: Släpvagnsmodulen kan diagnosticeras. Om tillverkarens diagnosprocesser eller programstödda testmekanismer genererar felrapporter, som direkt eller indirekt står i samband med driften av släpet skall släpvagnsmodulen skiljas från kablarna till släpvagnsdosan och en ny diagnosprocess skall startas.

Ingen garanti ges för tekniska ändringar, programuppdateringar, som genomförs efter idrifttagningen för första gången, t.ex. av fordonstillverkaren och som leder till felfunktioner vid användningen av släpet.

Ledningarna får inte vara klämda eller skadade. Montera alla tätningselement korrekt.

När släpvagnen är påhängd släcks dragfordonets dimbakljus.

Stickdosadaptern får bara användas i kombination med släpvagn.

- Om blinkerljusen på släpvagnen är ur funktion, visas detta genom att lampan i instrumentpanel blinkar snabbare än normalt.
- Med en extra kontrollampa i instrumentpanel visas släpvagnens blinkfunktion, eventuellt krävs kodning
- Om blinkerljusen på släpvagnen är ur funktion, visas detta med en kontrollampa (en signalgivare) i cockpiten, eventuellt krävs kodning.

Släpvagnsfunktionerna ska kontrolleras med hjälp av en påhängd släpvagn eller en provningsutrustning med belastningsmotstånd.

Observera! Det skall säkerställas att samtliga krav från fordonstillverkaren gällande ändringar på och kompletteringsutrustning av fordonet och/eller kylsystemet för användning med släp har genomförts.

Den tyska texten i denna anvisning är bindande.

Ändringar förbehålls.

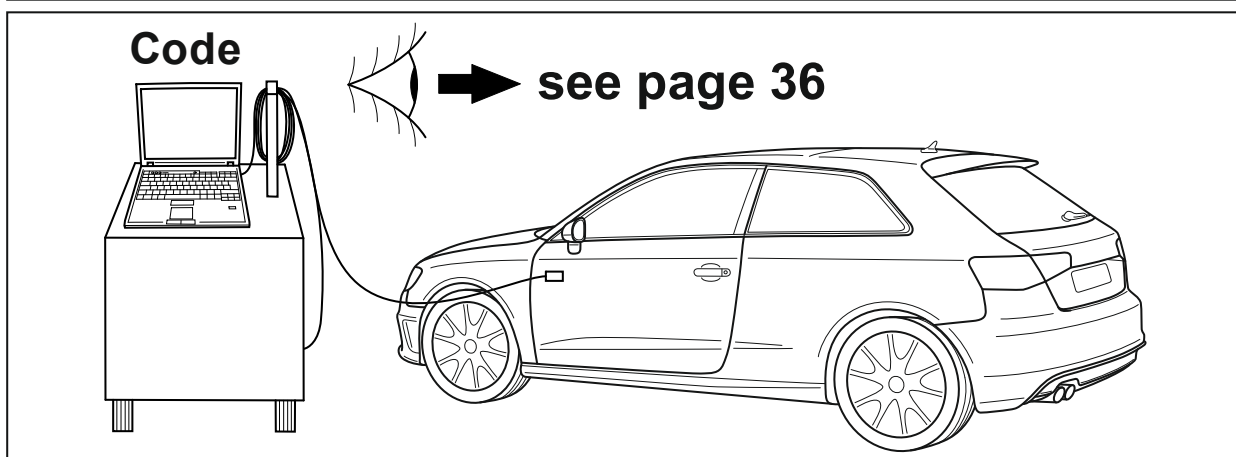
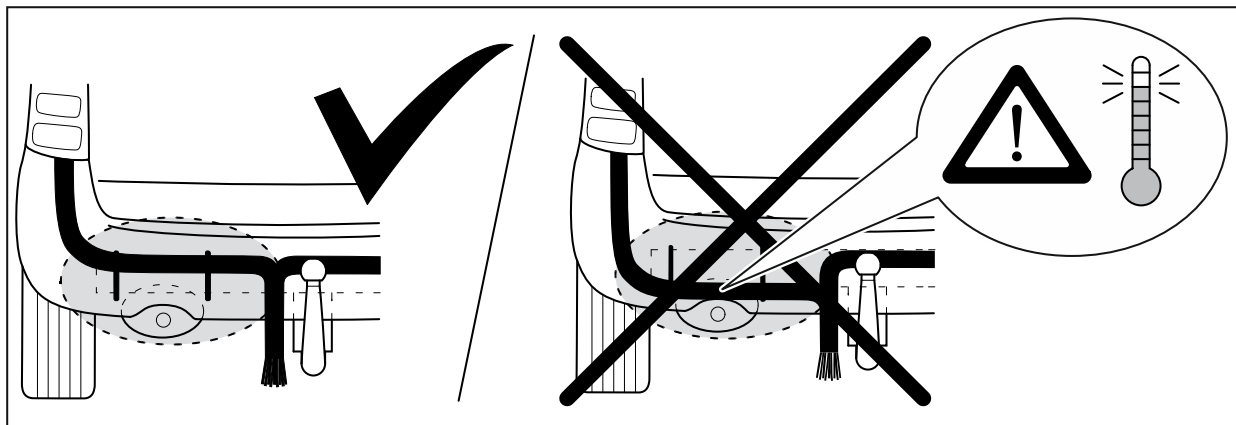
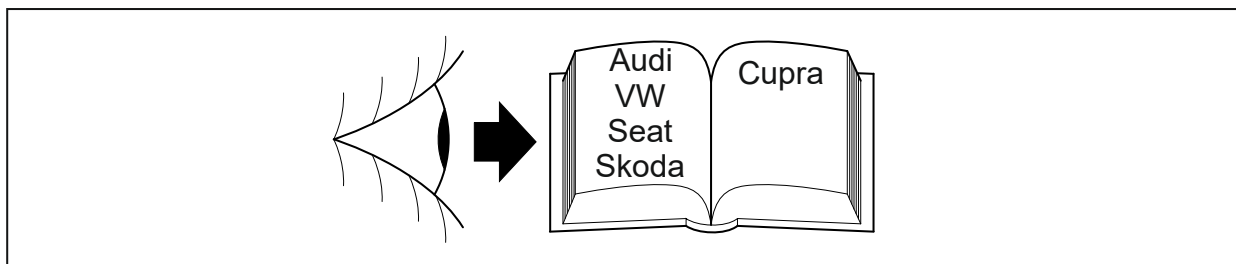

1

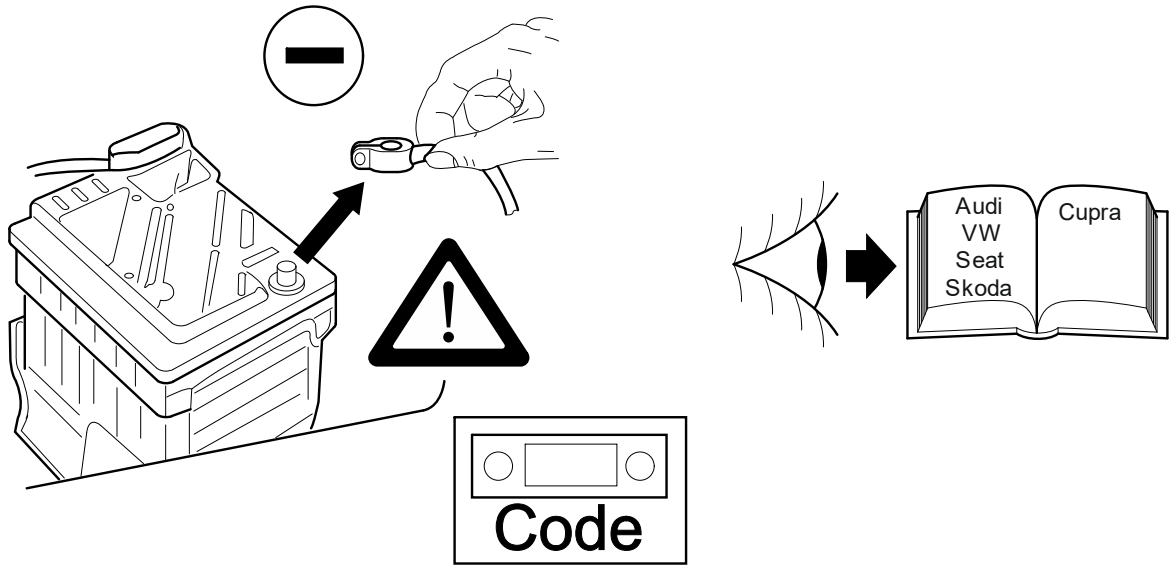

2

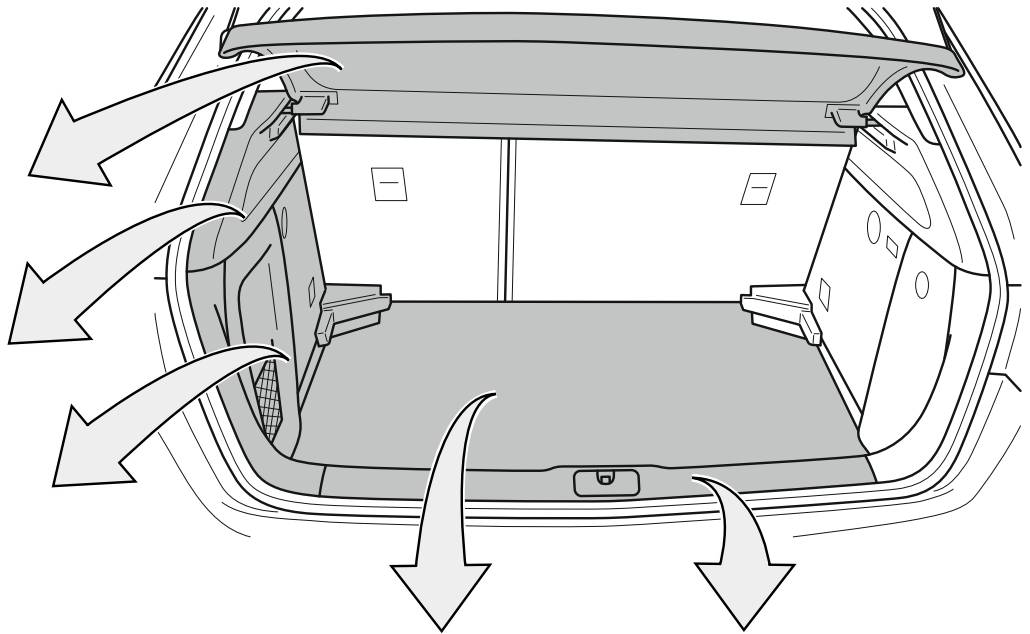
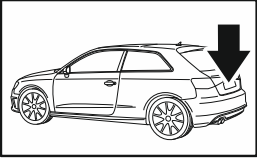

3a

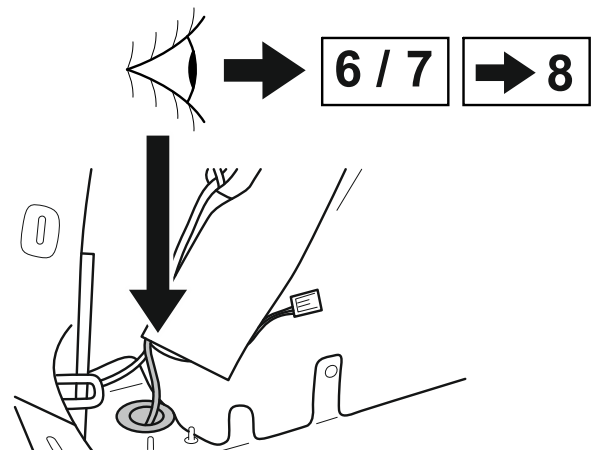
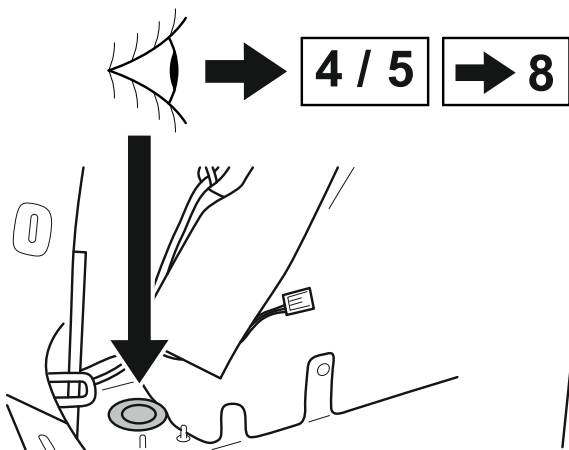
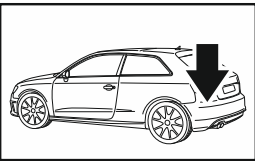

3b

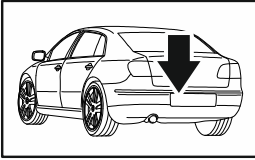

Passat B8 Superb III Octavia

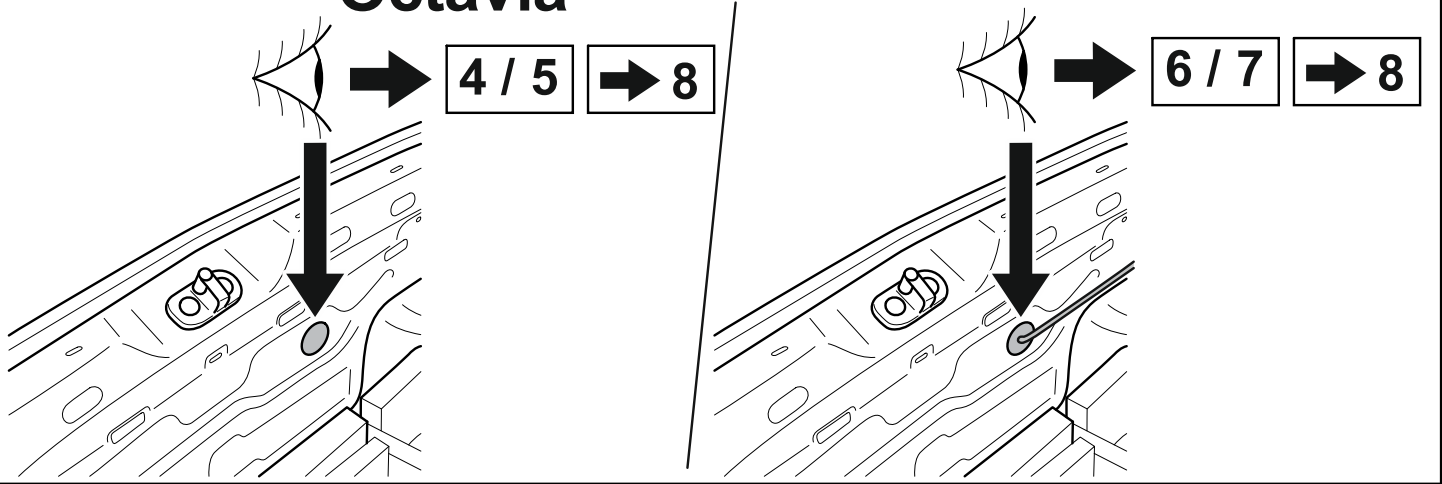

4

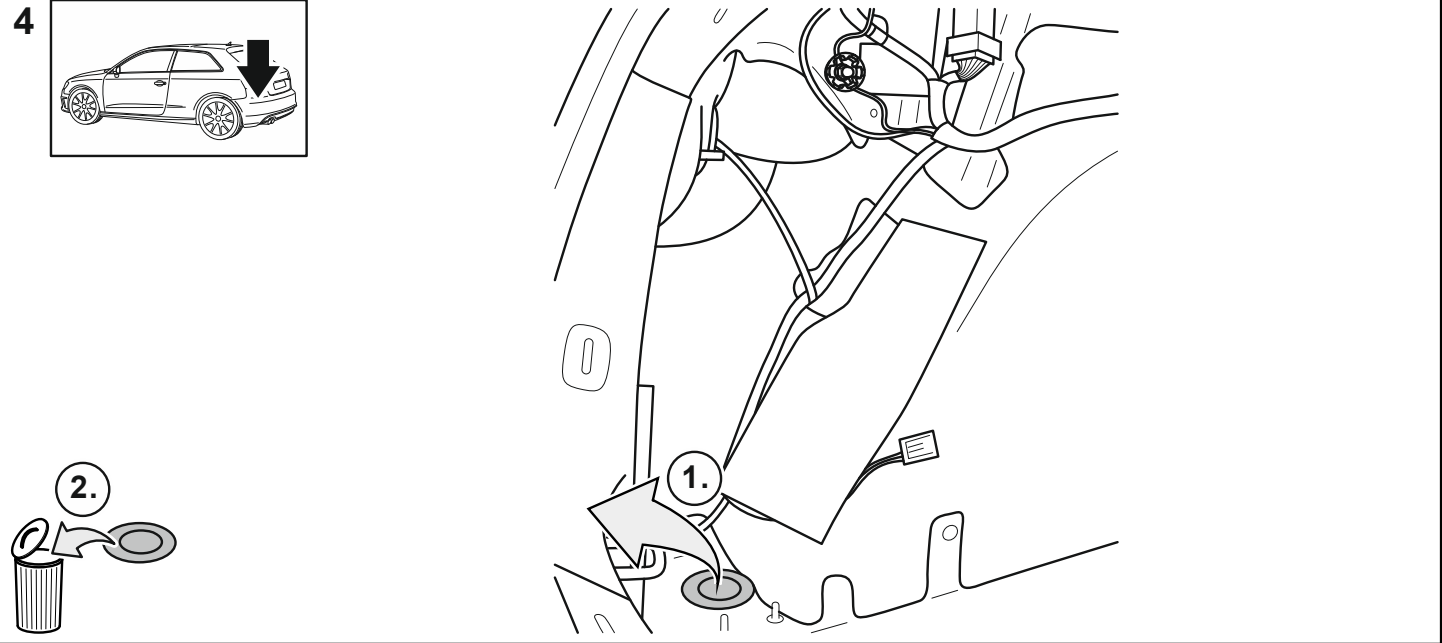
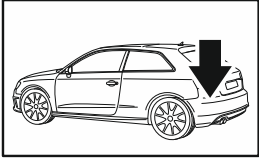

5

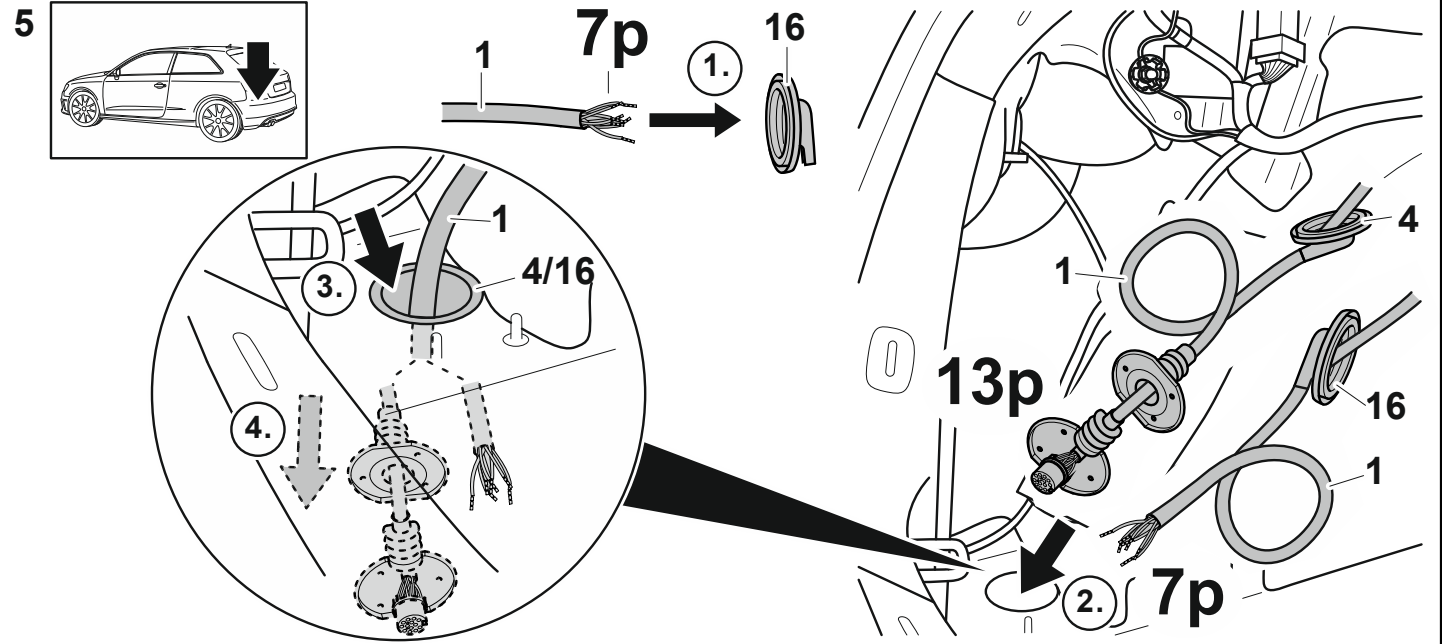
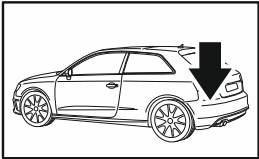

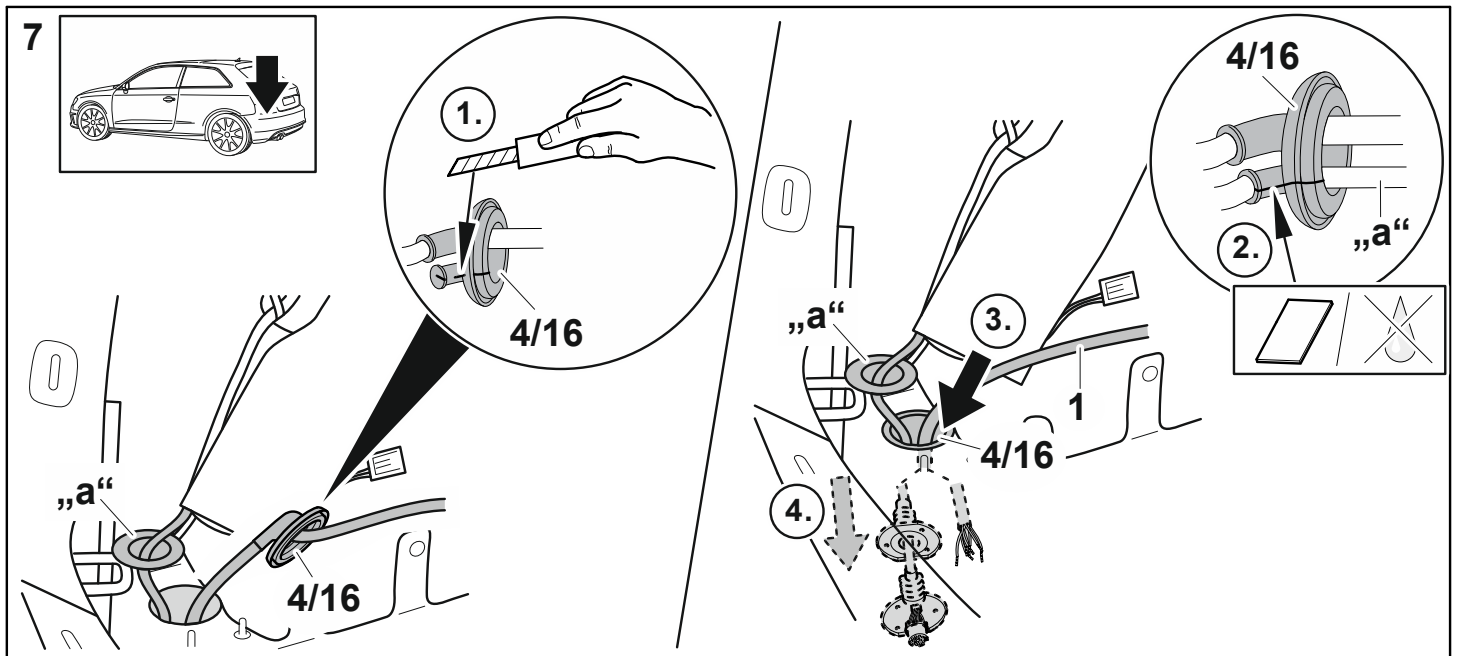
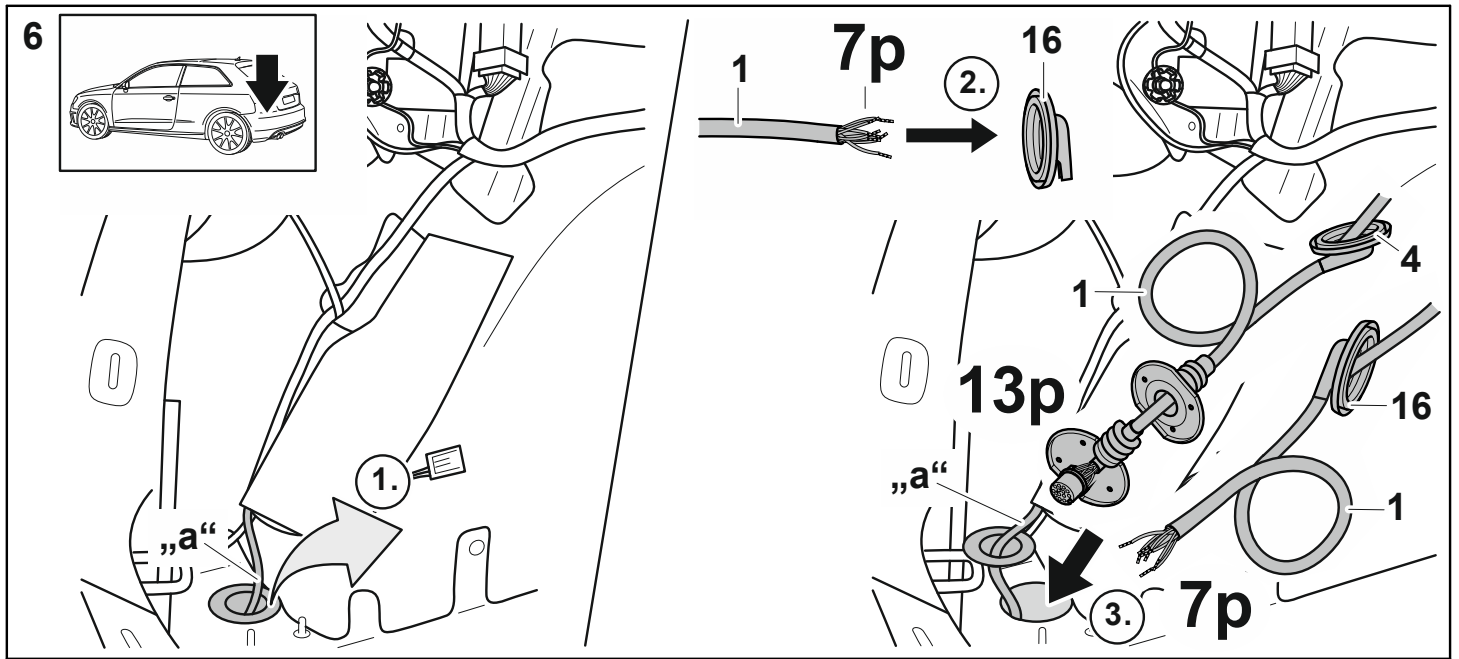

8a

7p

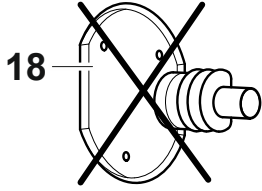

- 3x M5x25
- 3x M5
- 3x B5

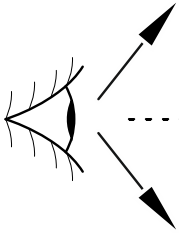
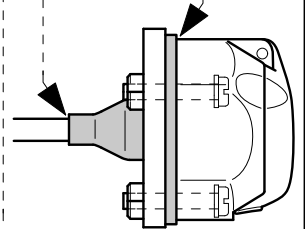
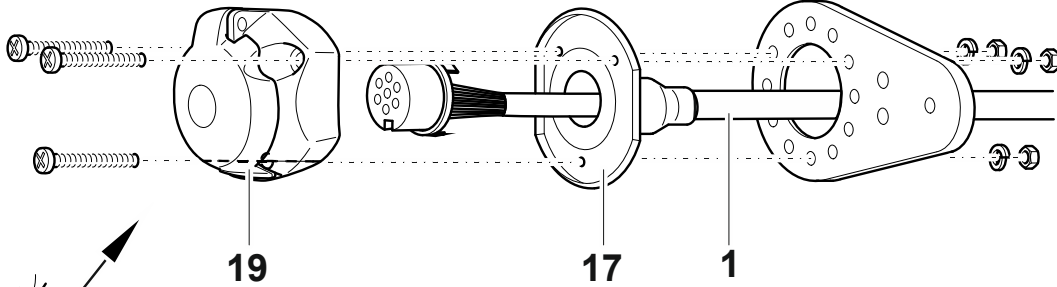
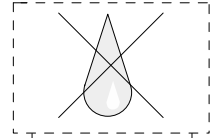

7p

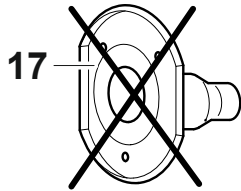

- 3x M5x25
- 3x M5
- 3x B5

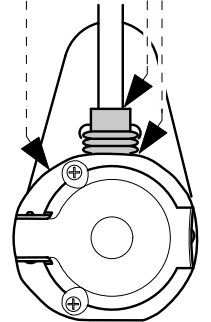
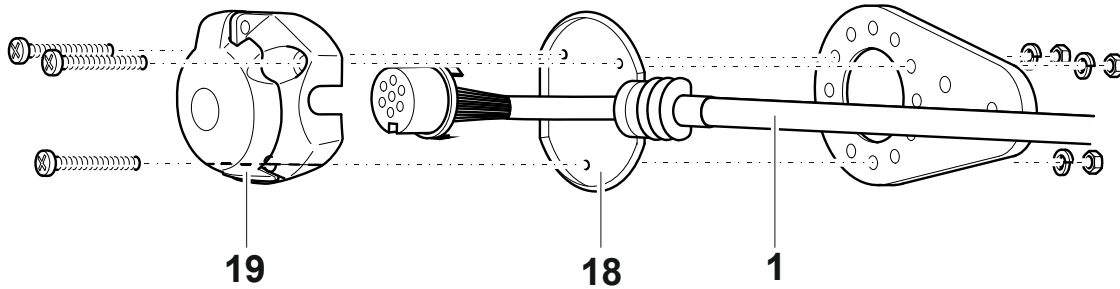
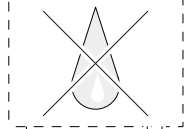

8b

13p

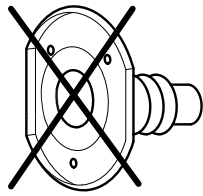

3x M5x35

3x M5

3x B5

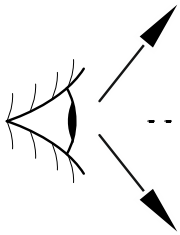
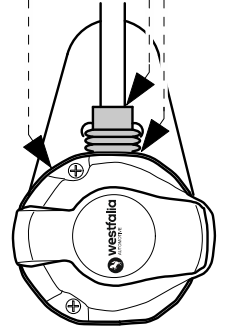
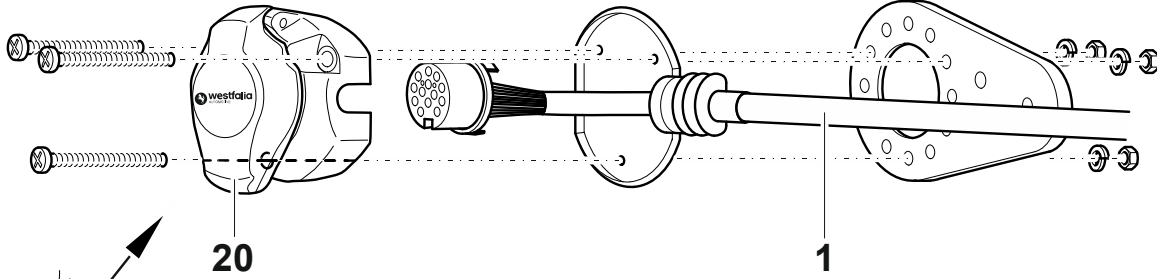

13p

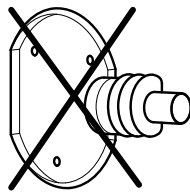

3x M5x35

3x M5

3x B5

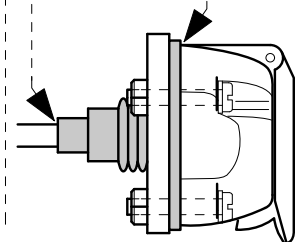
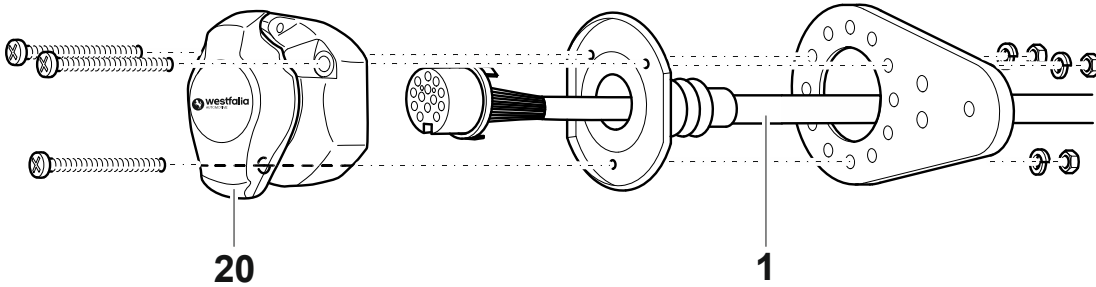

9

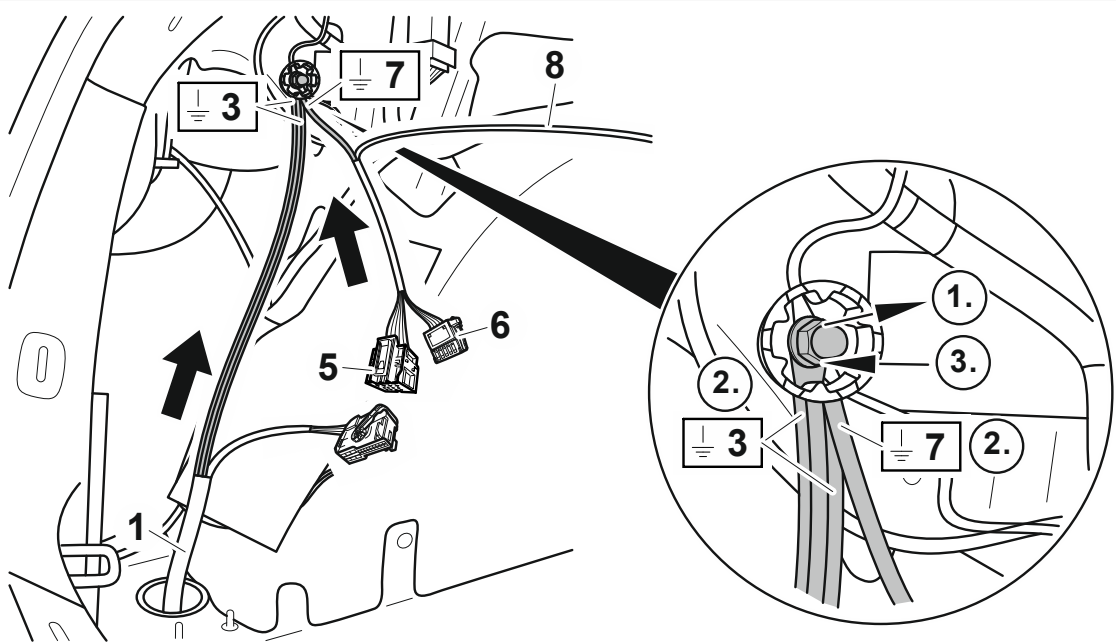
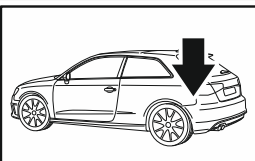

10

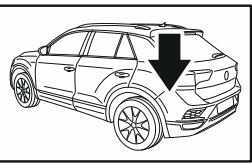
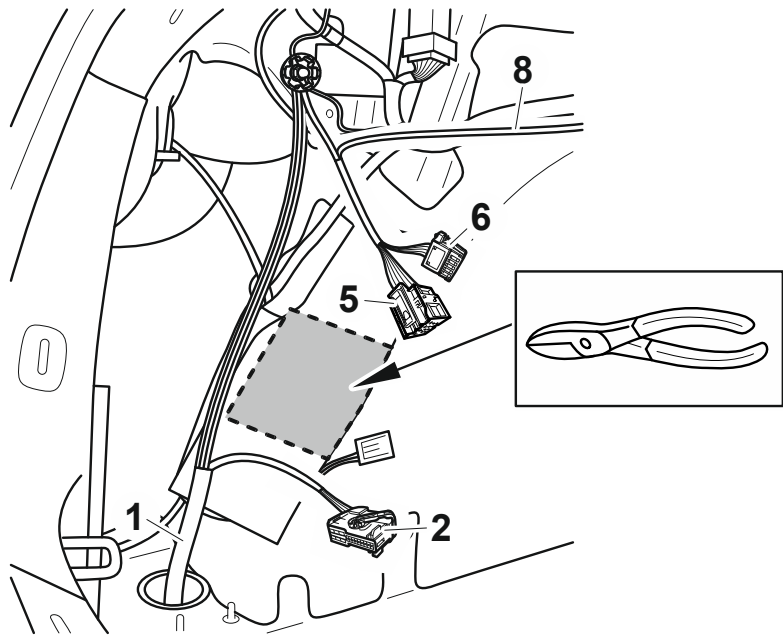
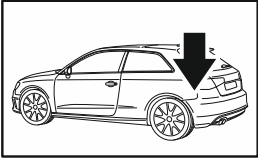

**T-Roc
Karoq
Ateca**

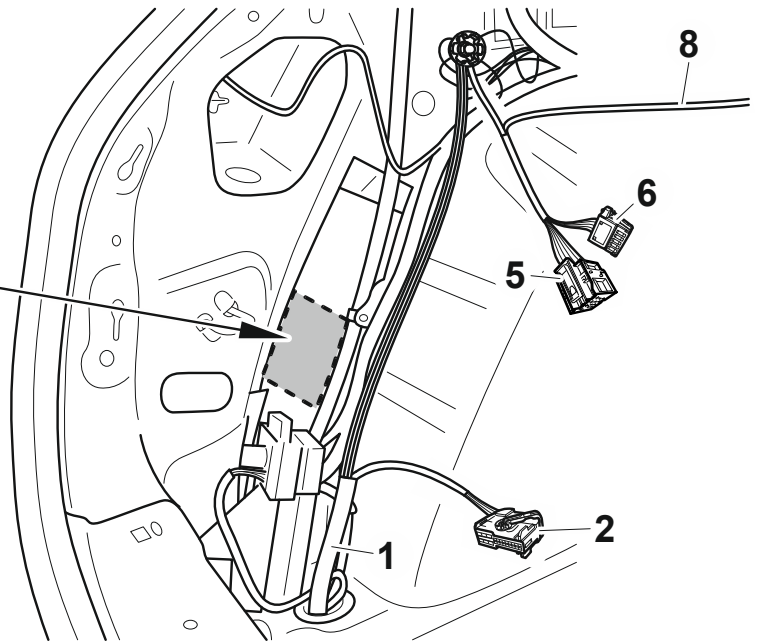
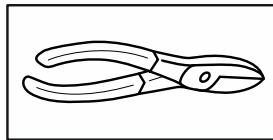

11

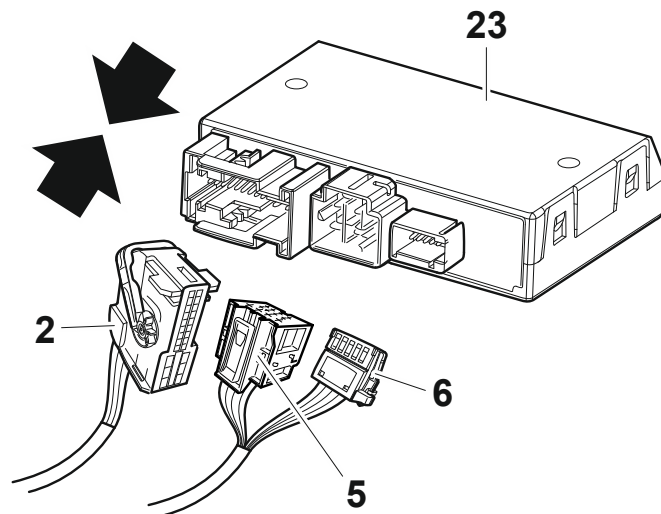
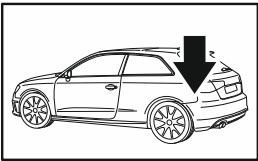

12

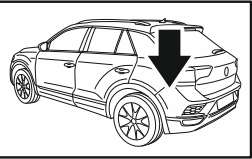
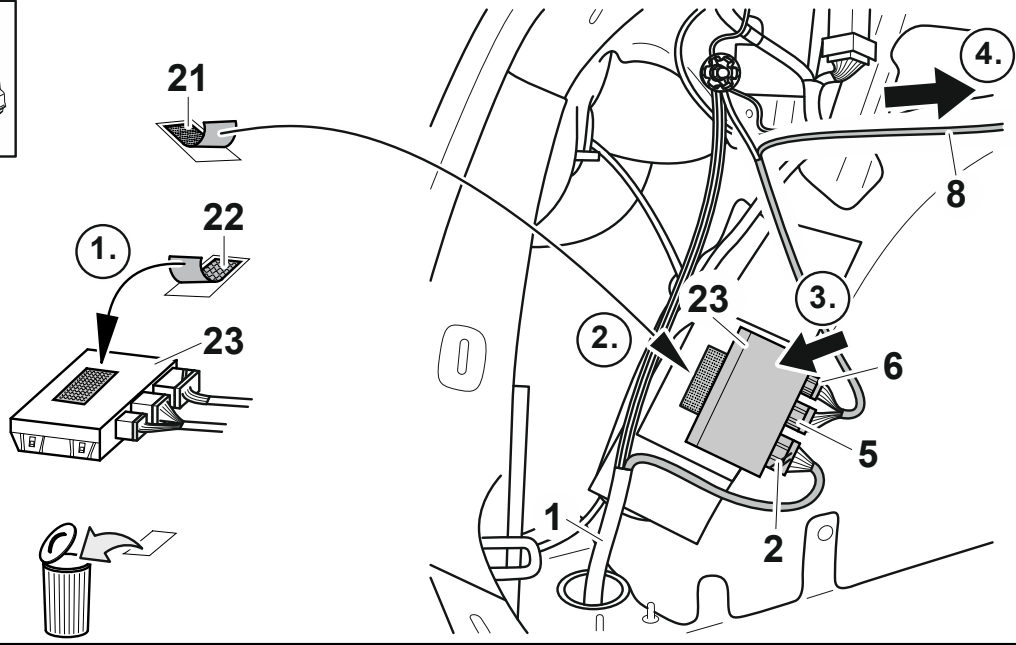
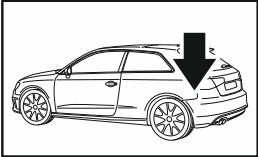

**T-Roc
Karoq
Ateca**

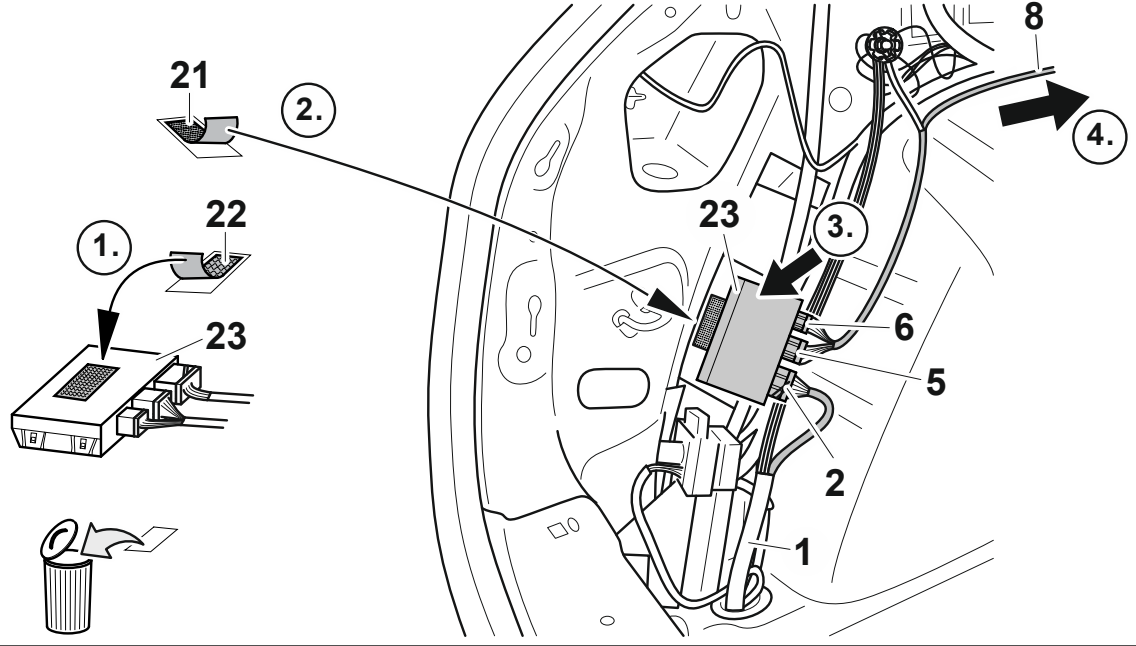

13

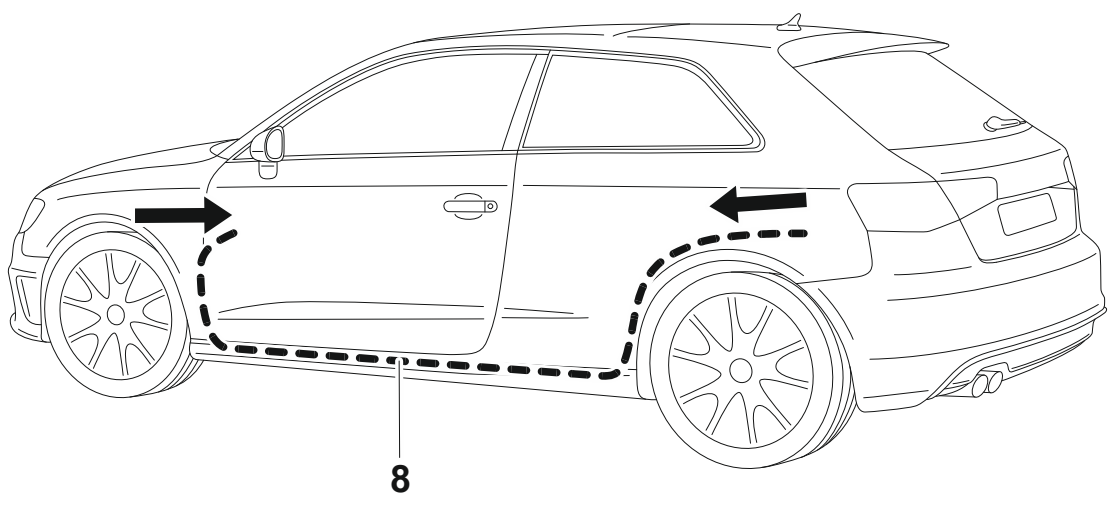

14

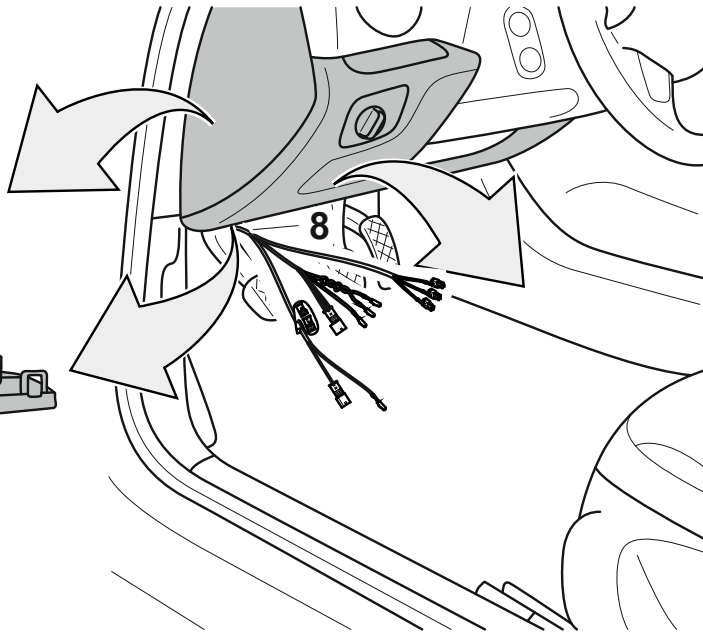
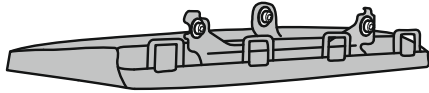
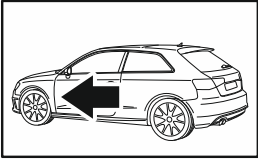

15

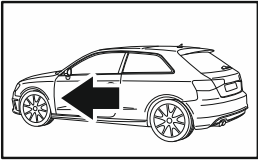

BCM

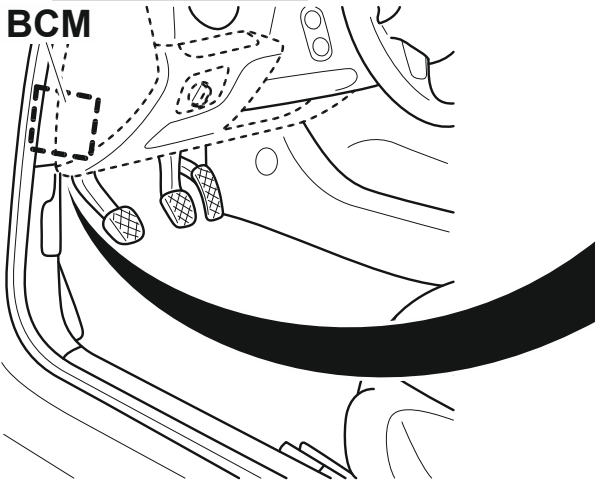

BCM

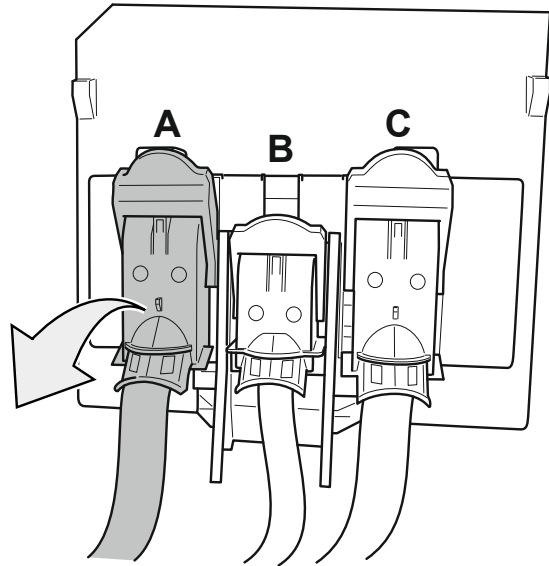

16

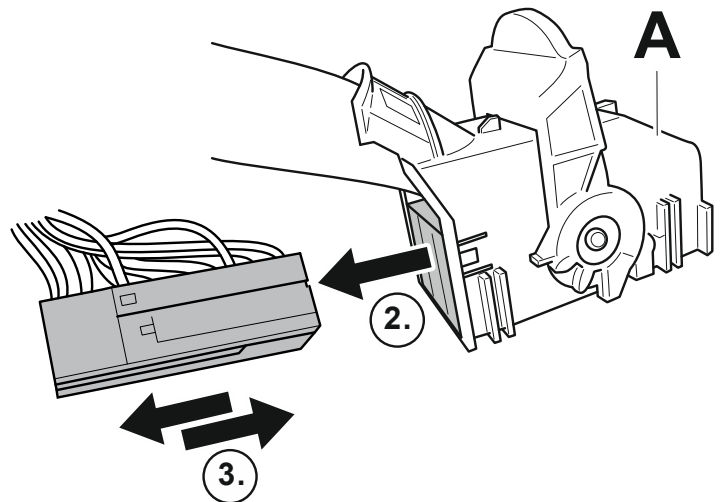
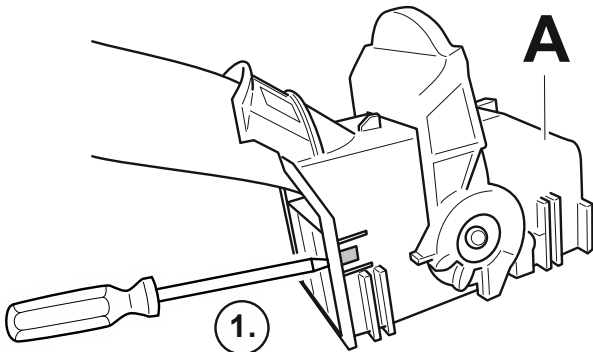

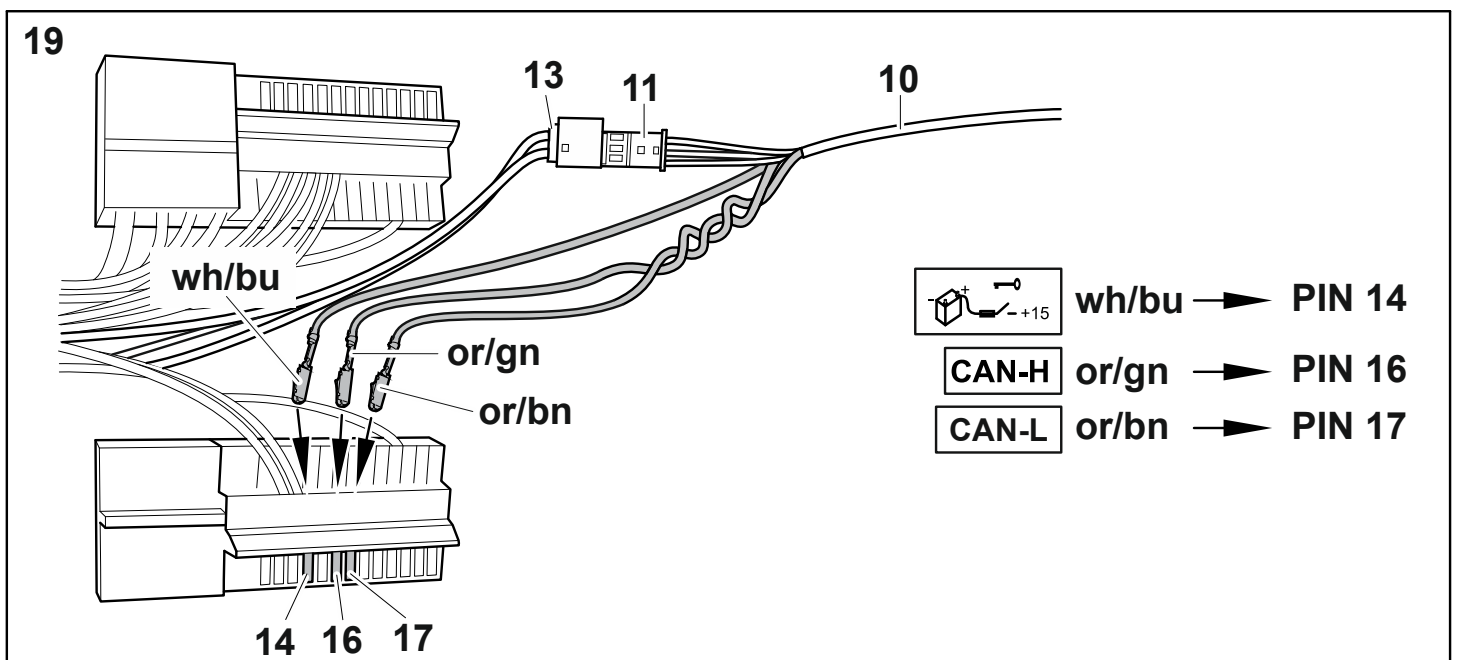
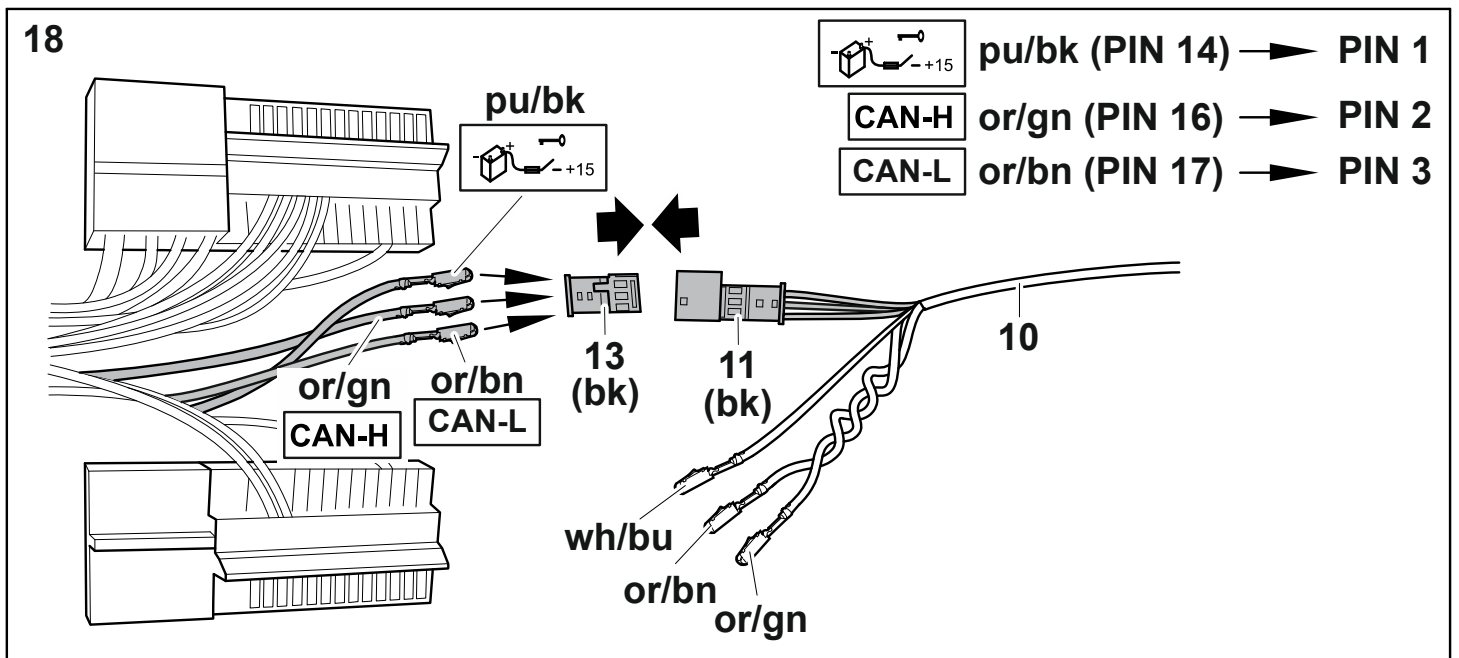
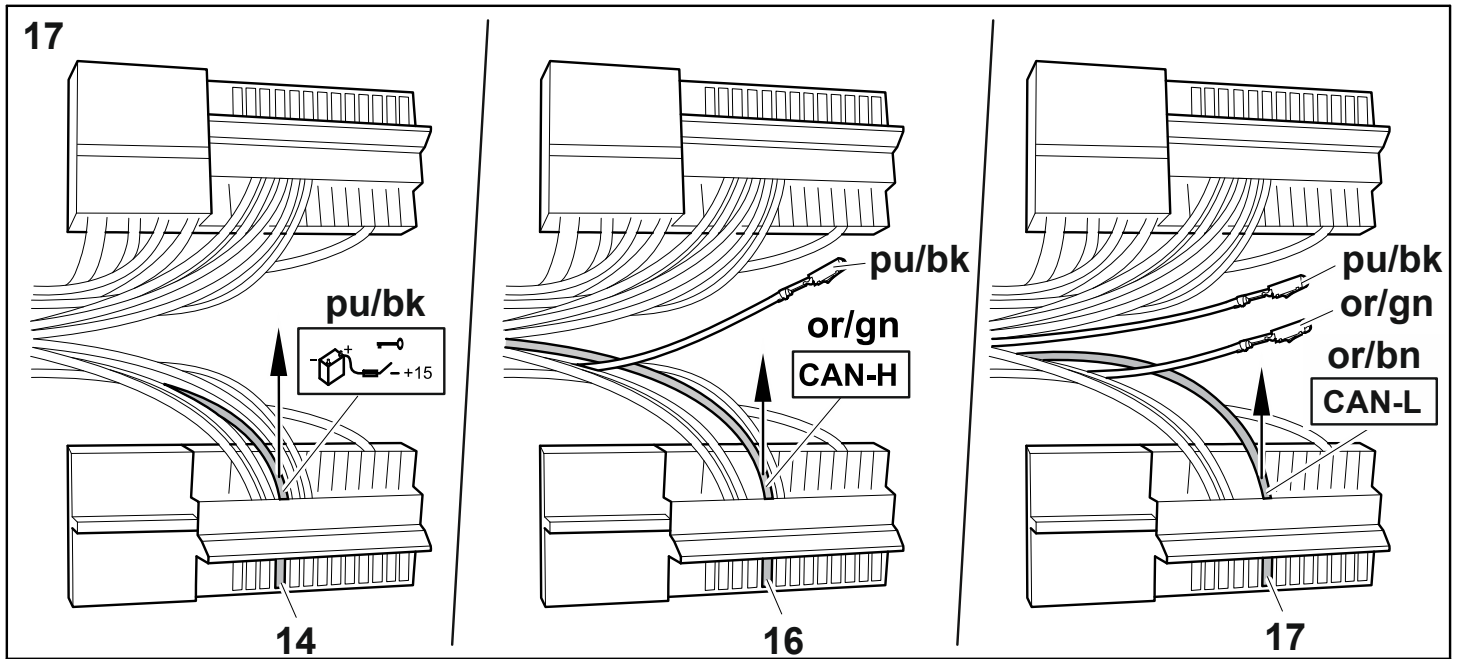

20

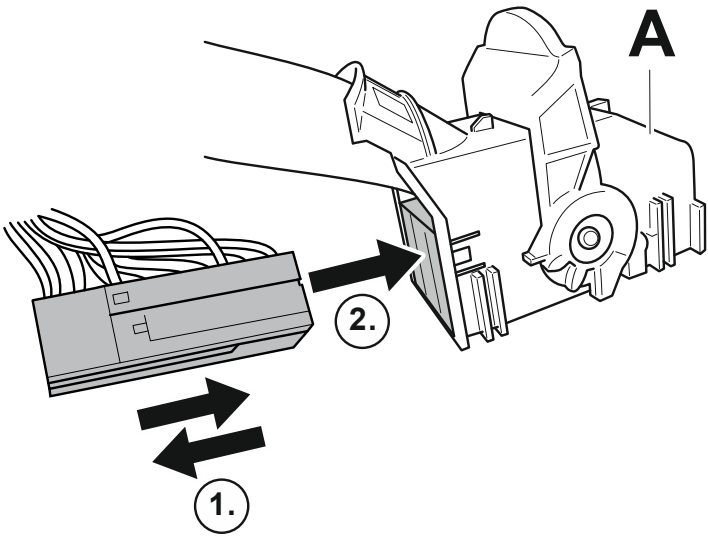

1x 150mm

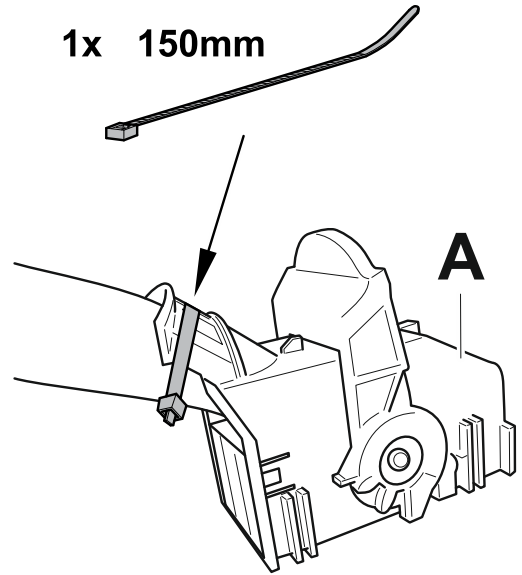

21

BCM

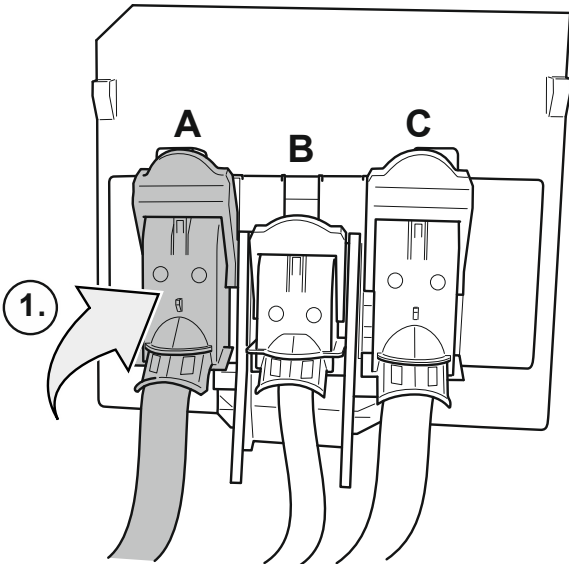

BCM

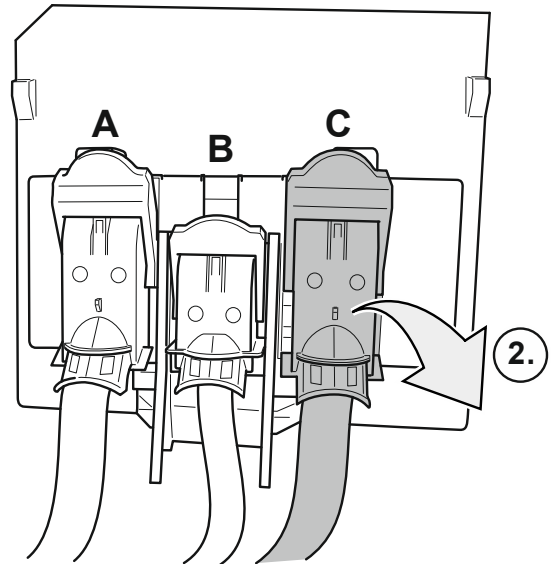

22

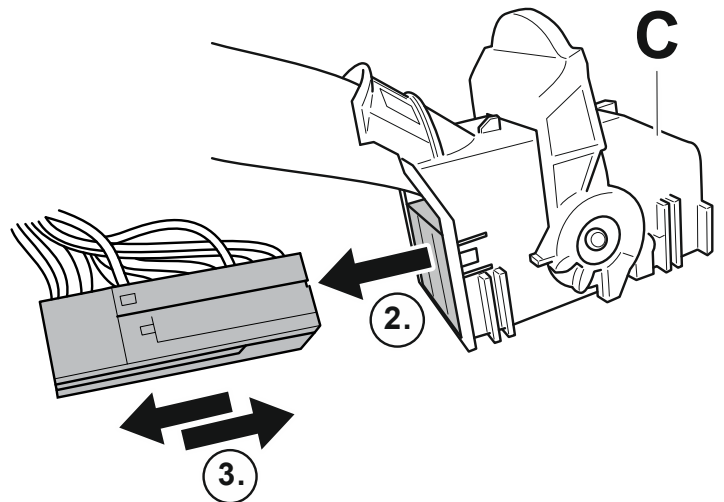
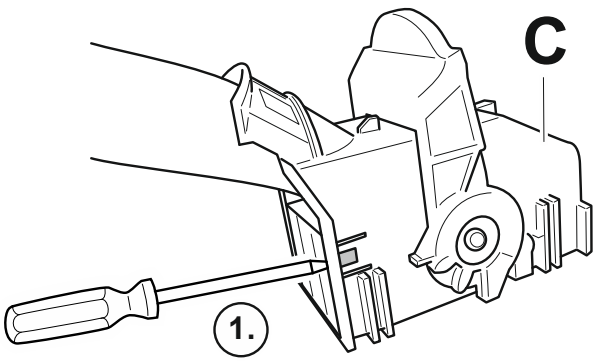

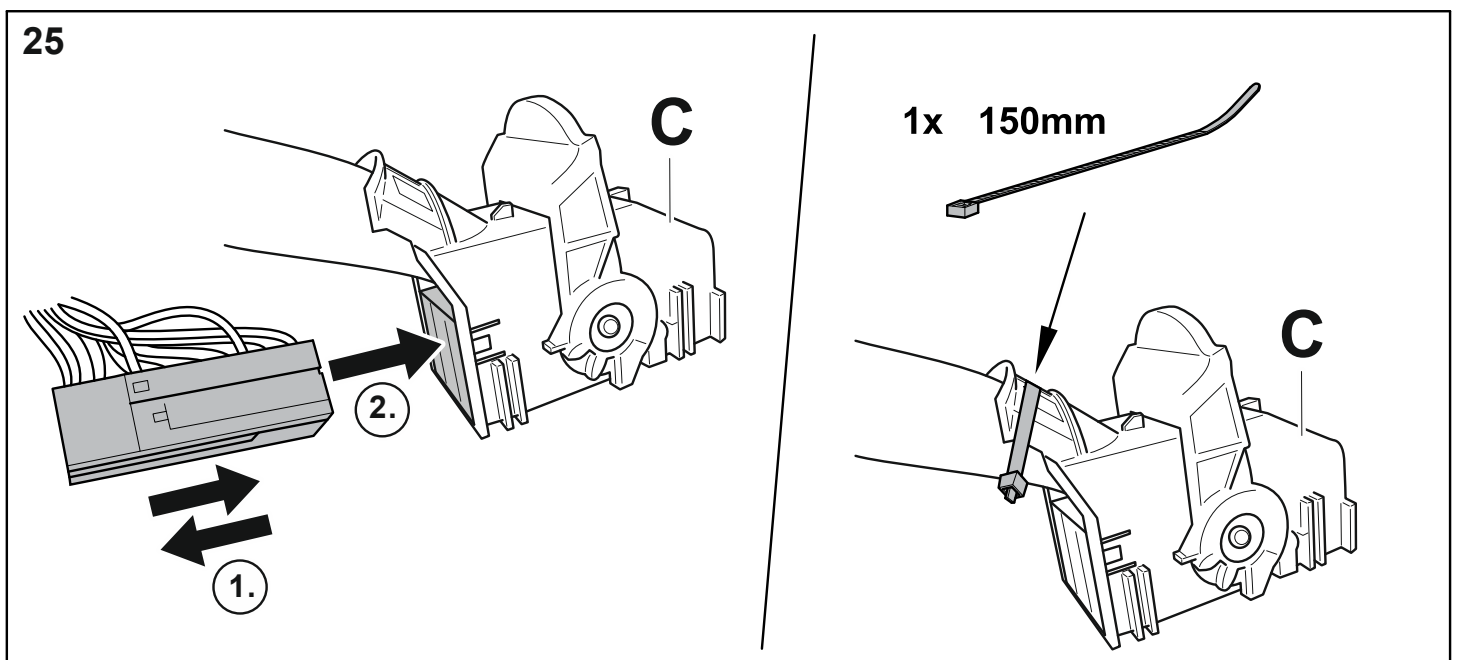
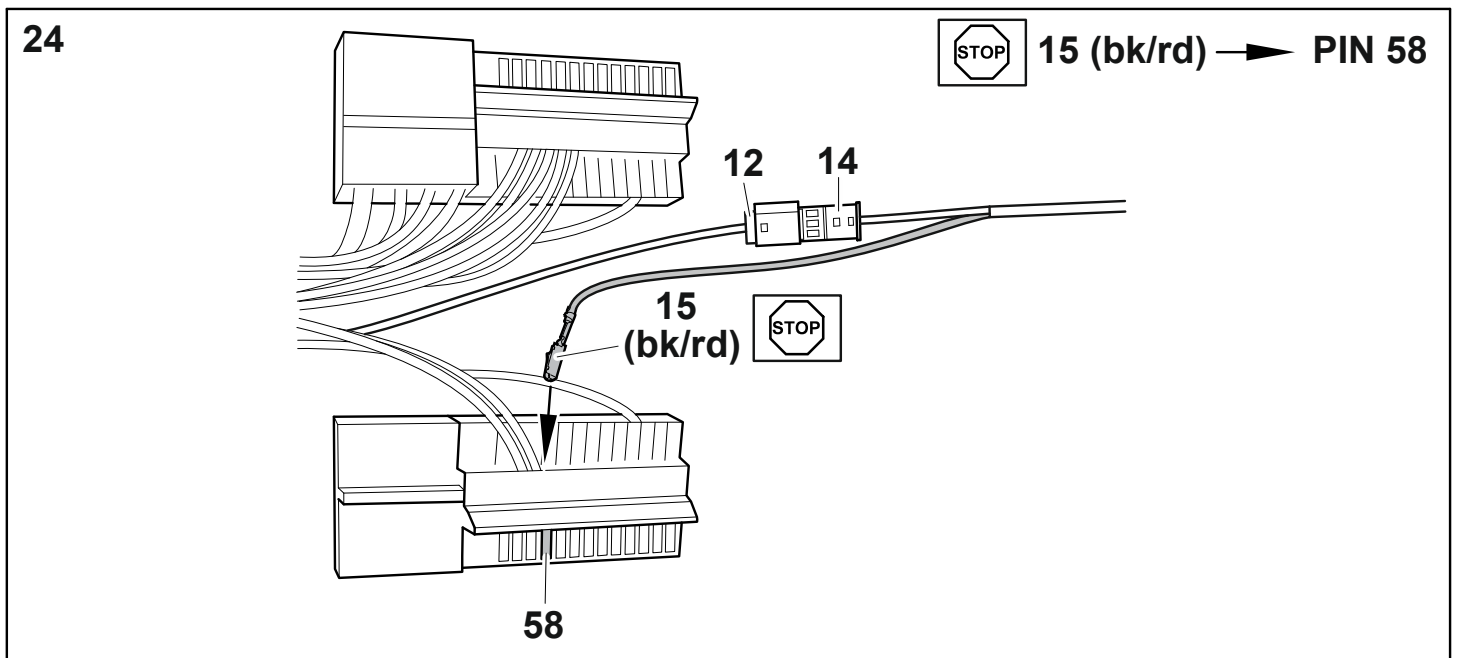
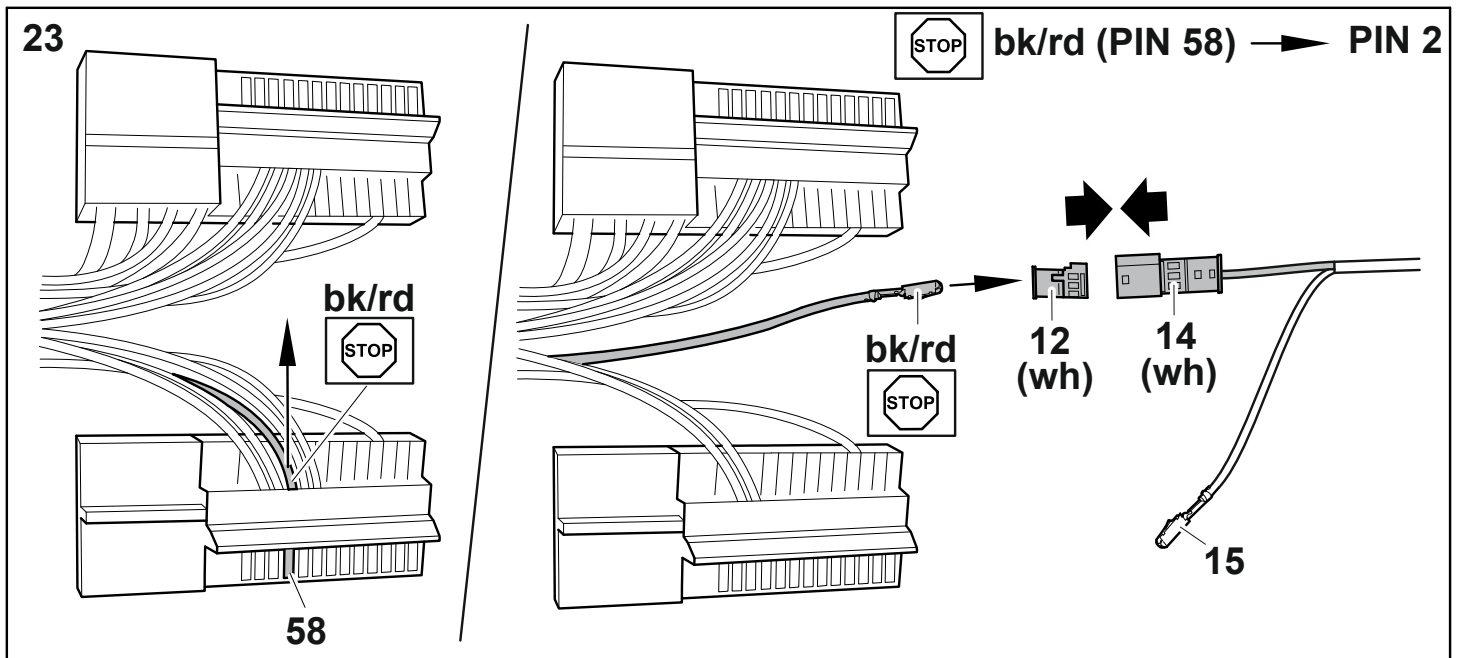

26

BCM

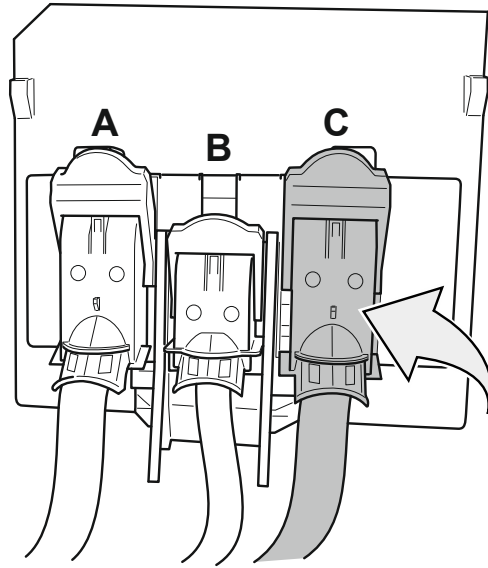

27

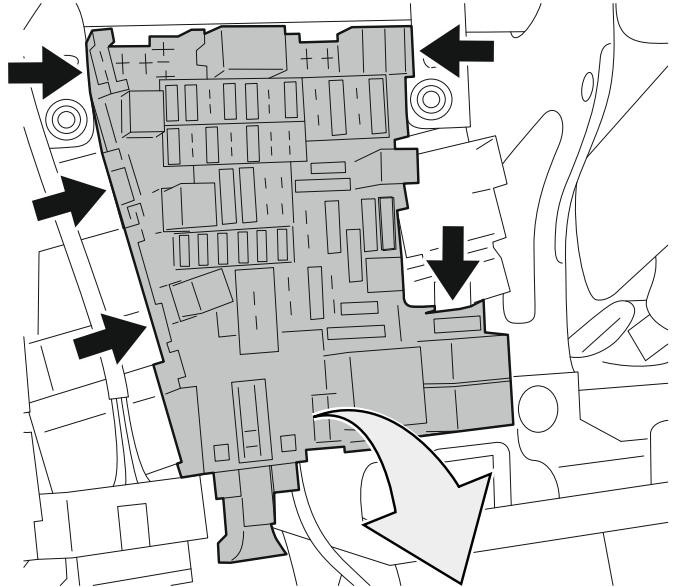
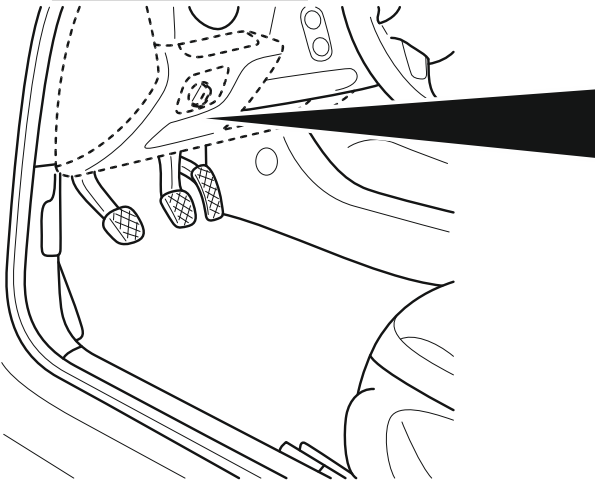
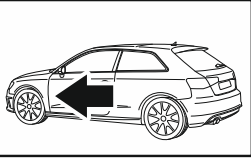

28

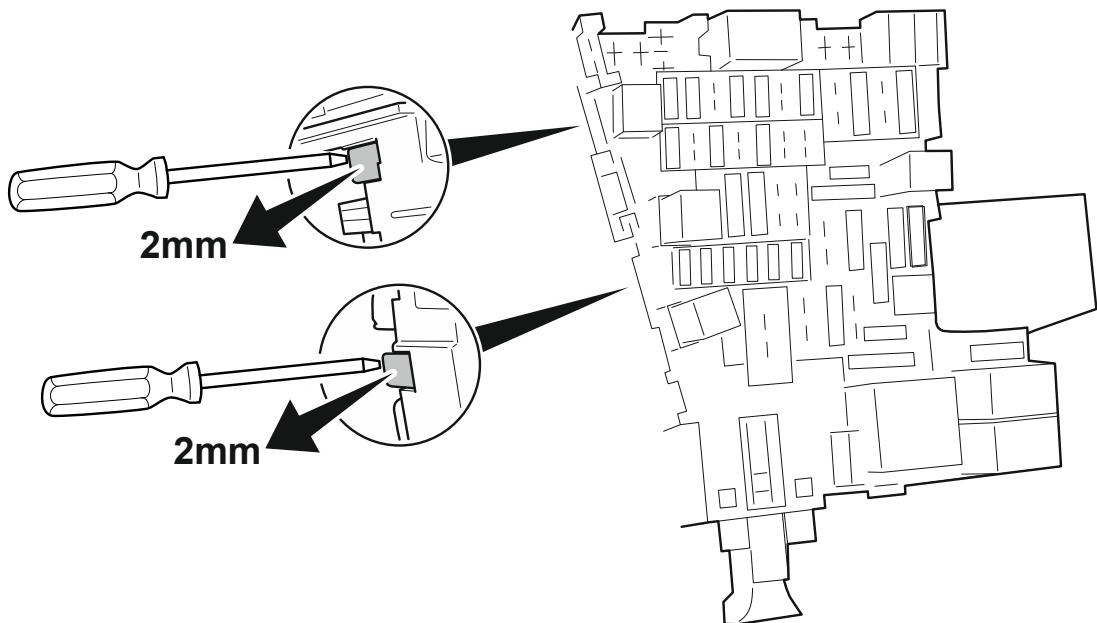

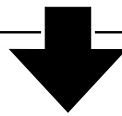
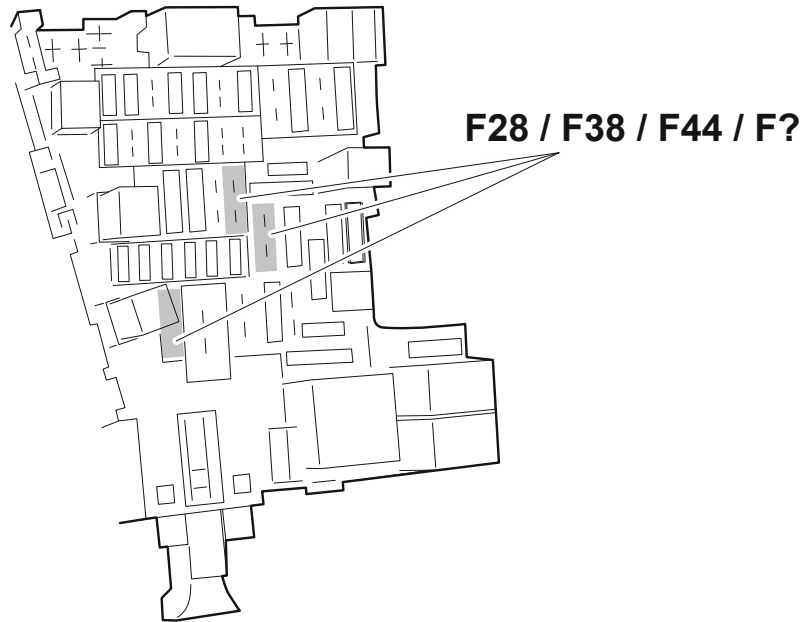

VW
Seat
Cupra
Skoda

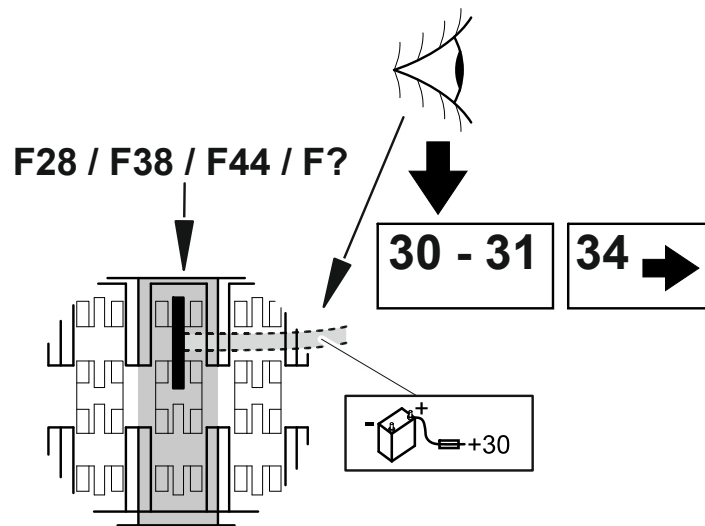

30 **VW
Seat
Cupra
Skoda**

7p/13p

24 — 25A

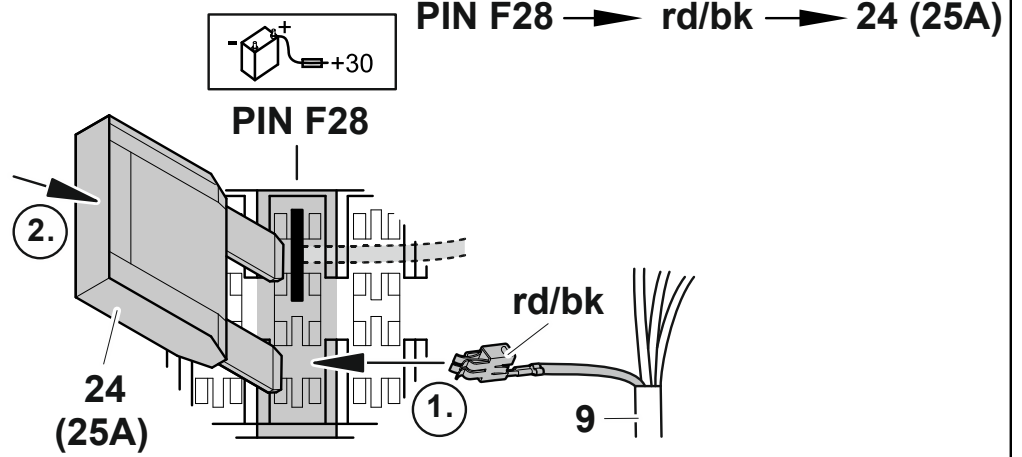

7p/13p

24 — 25A

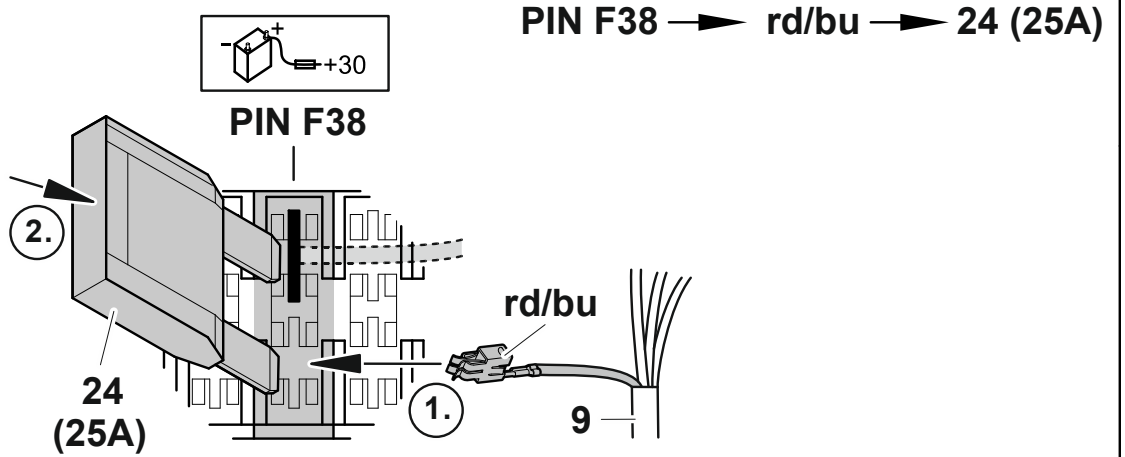

13p

25 — 15A

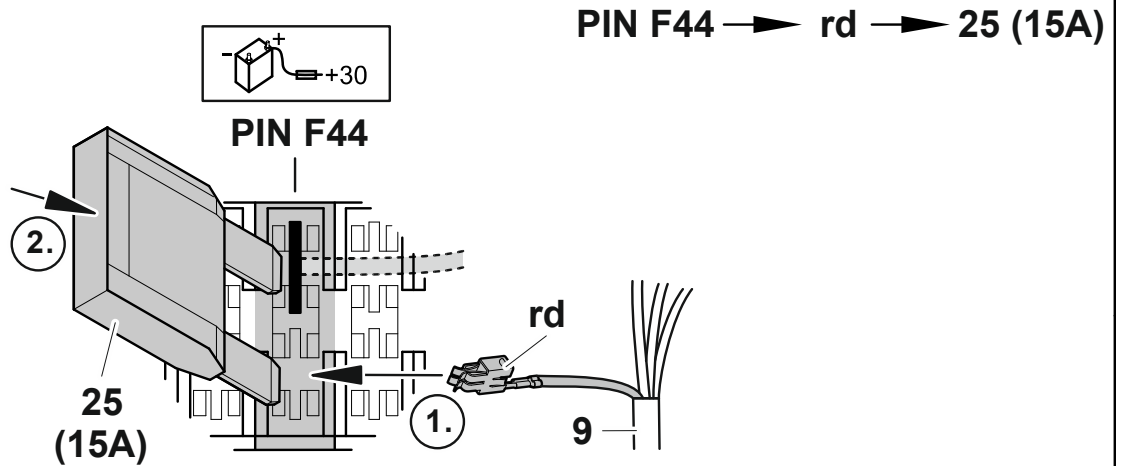

13p

25 — 15A

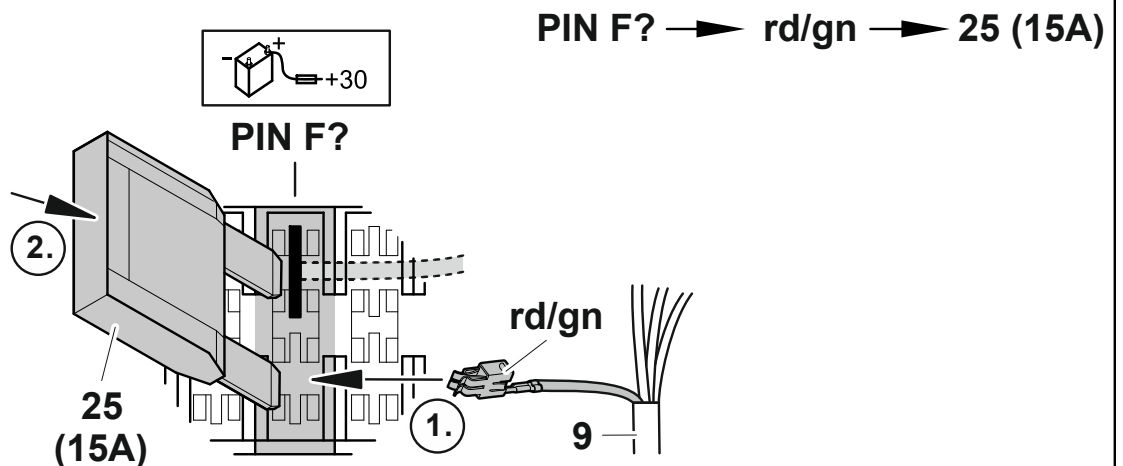

31

VW Seat Cupra Skoda

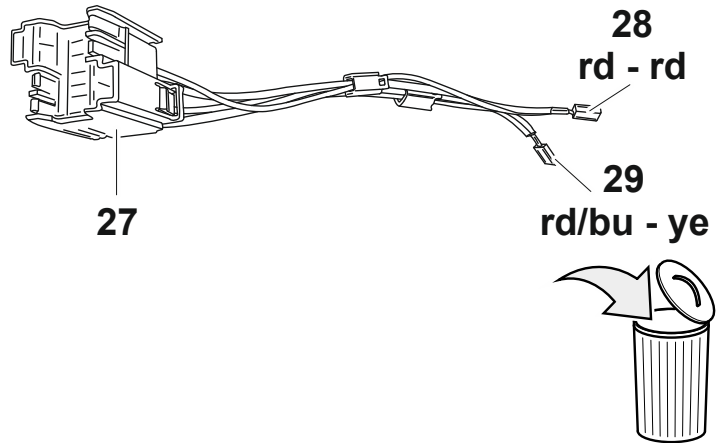

32a Audi A3 Audi Q2

- (7p/13p) PIN 1 → rd/bk → 25A
- (13p) PIN 2 → rd → 15A
- (7p/13p) PIN 3 → rd/bu → 25A
- (13p) PIN 4 → rd/gn → 15A

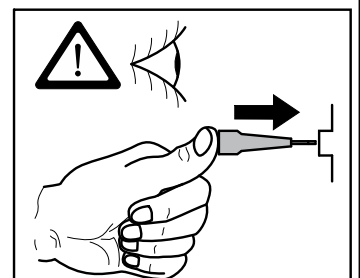
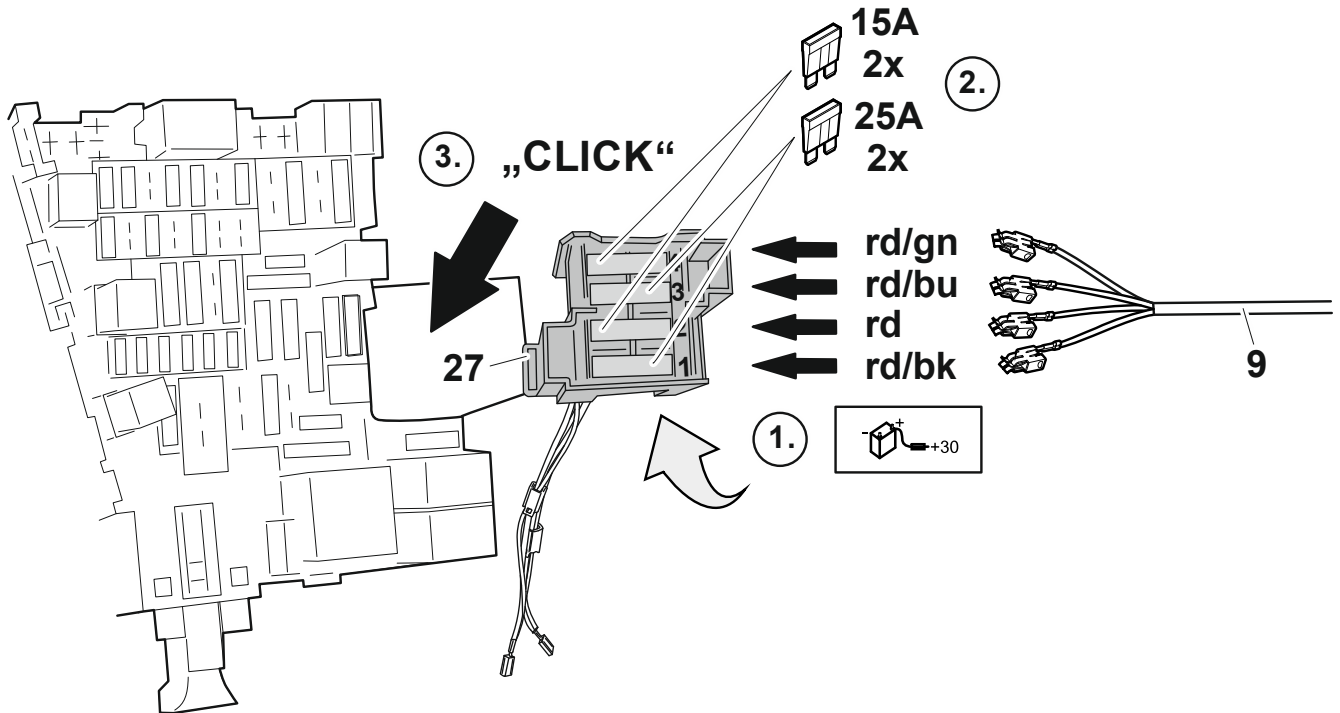

32b Audi Q3 Audi Q3 Sportback

- (7p/13p) PIN 1 → rd/bk → 25A
- (13p) PIN 2 → rd → 15A
- (7p/13p) PIN 3 → rd/bu → 25A
- (13p) PIN 4 → rd/gn → 15A

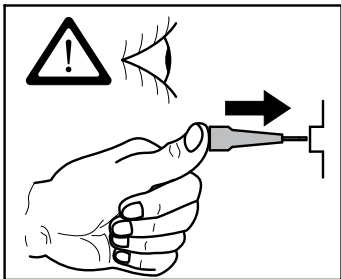
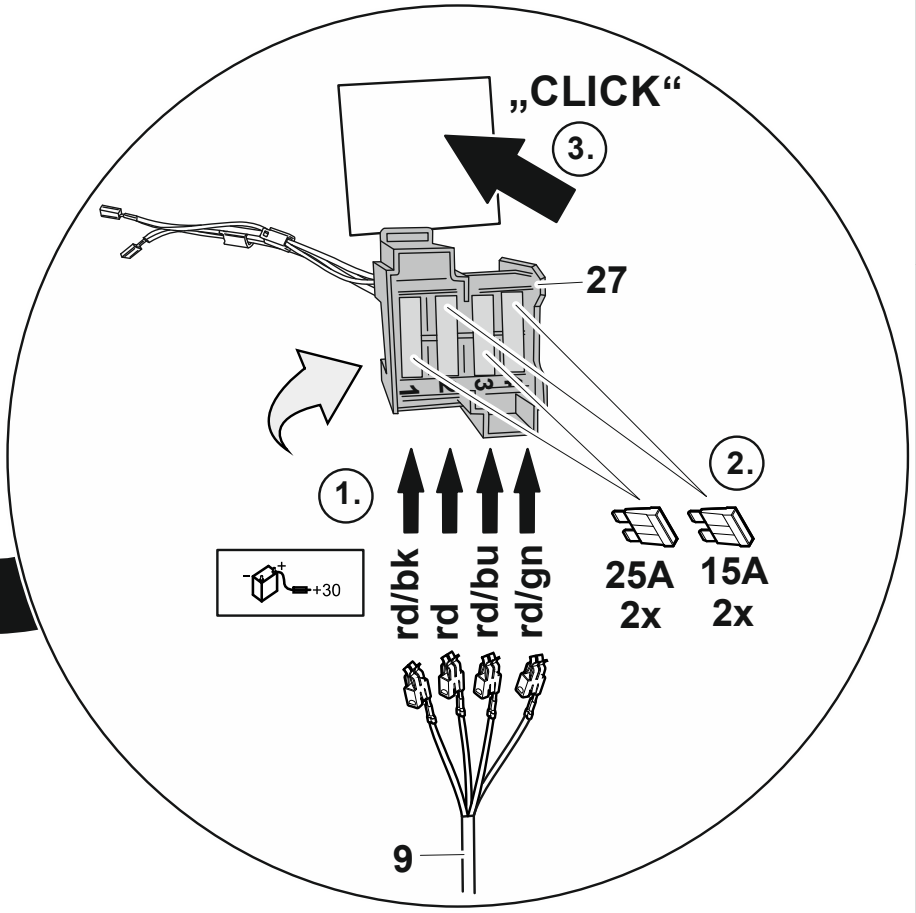

33a Audi A3 Audi Q2

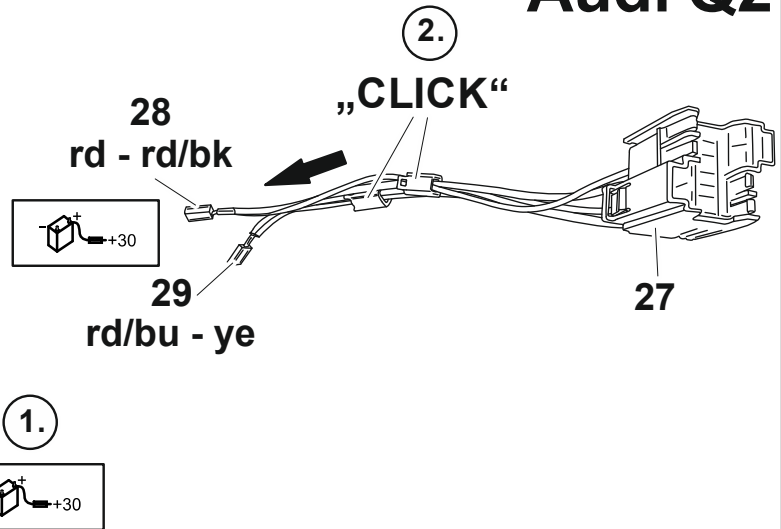
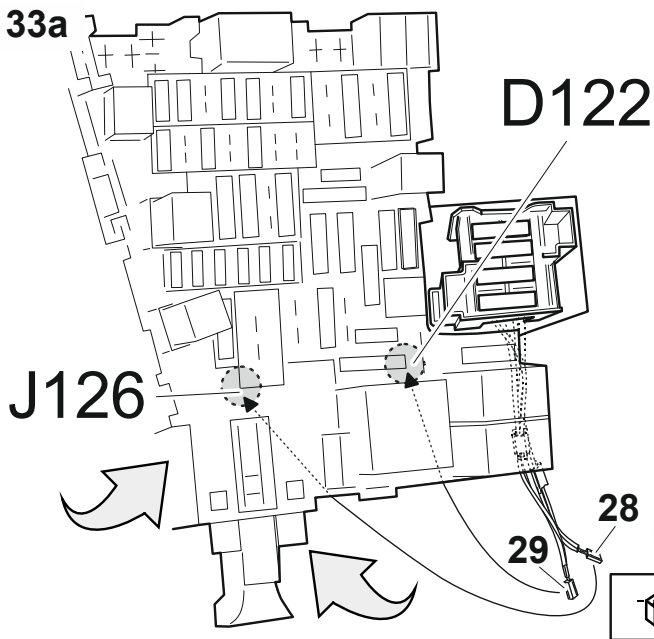

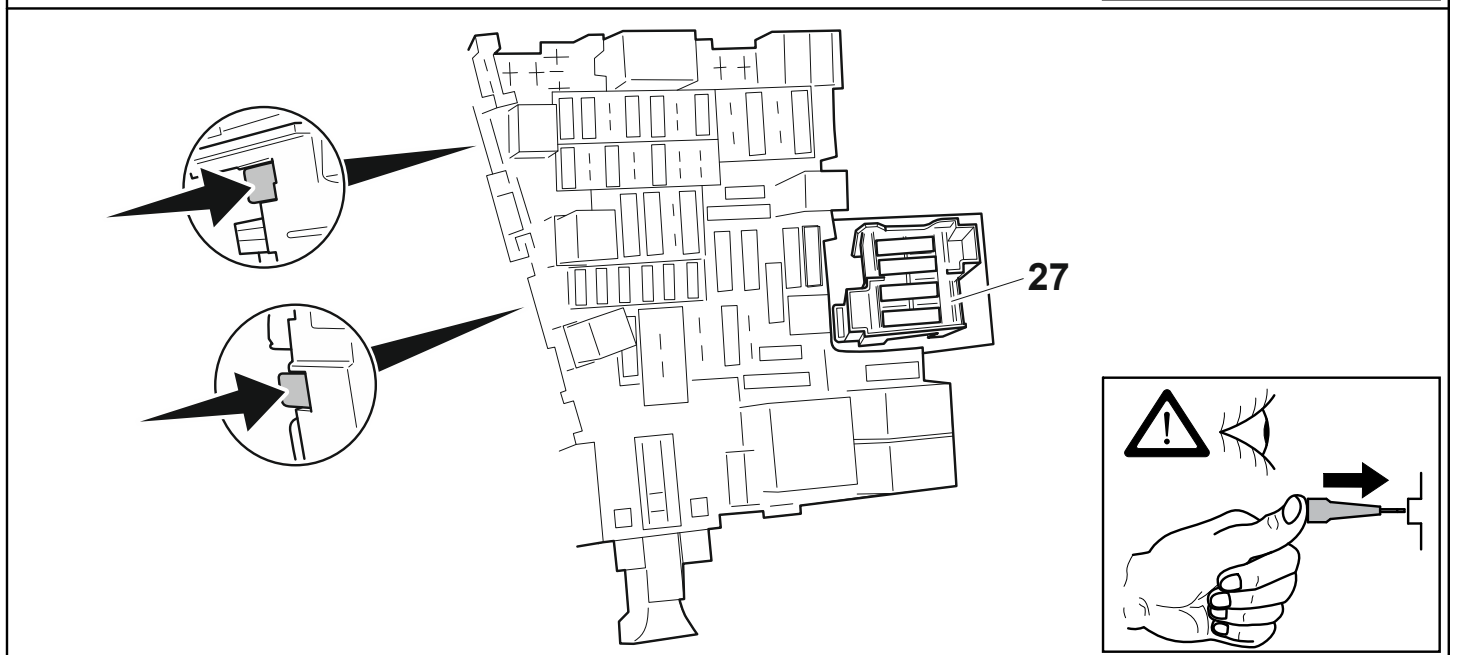
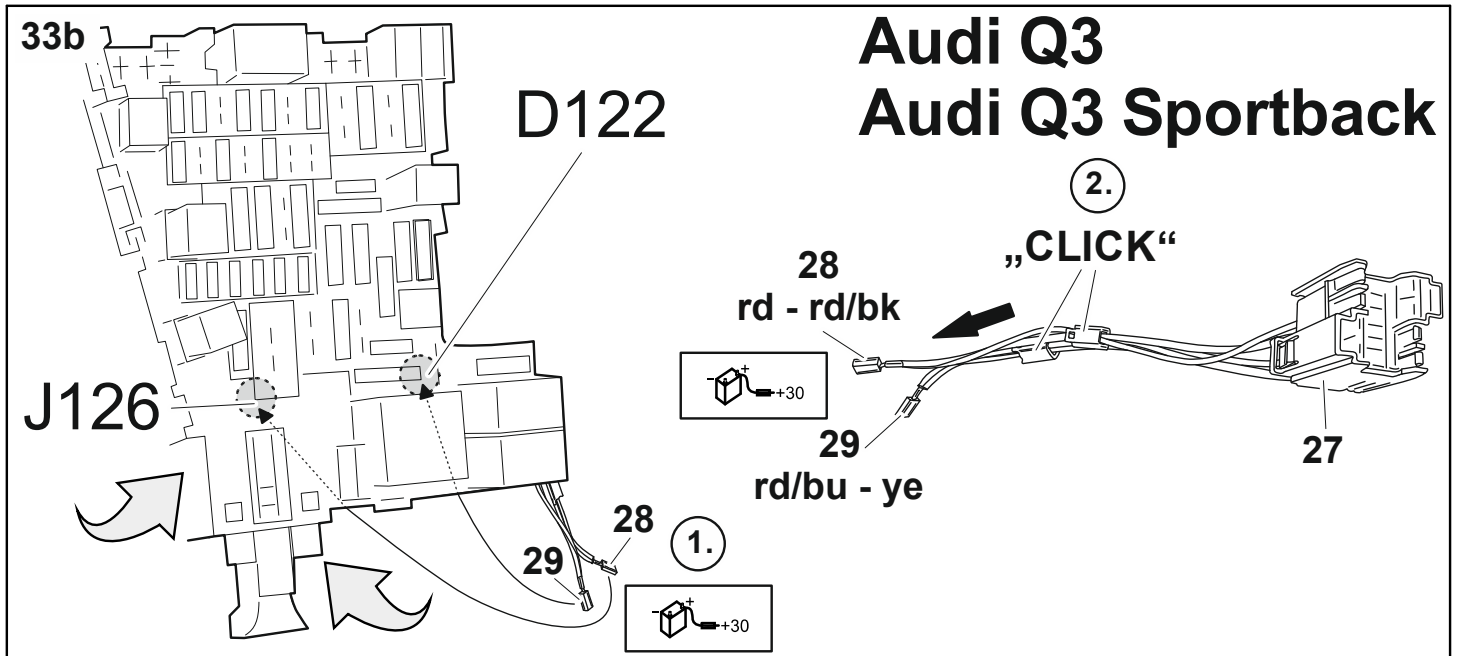

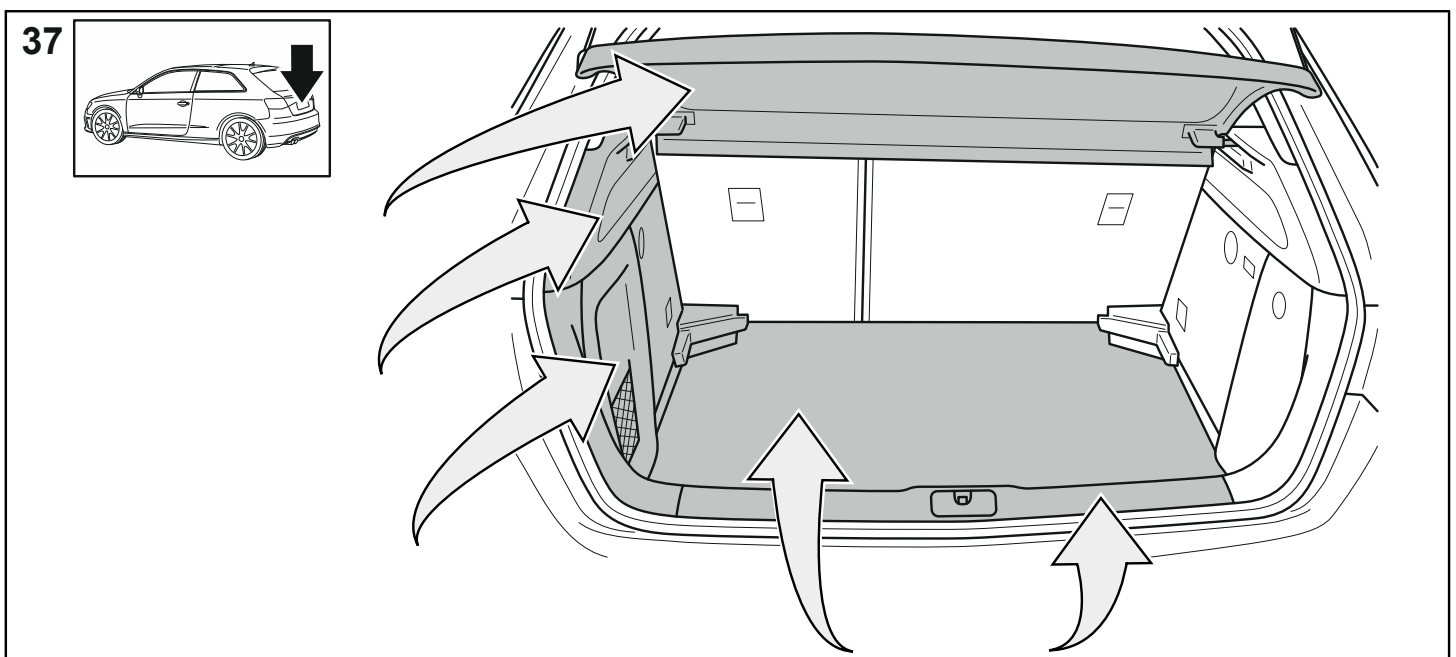
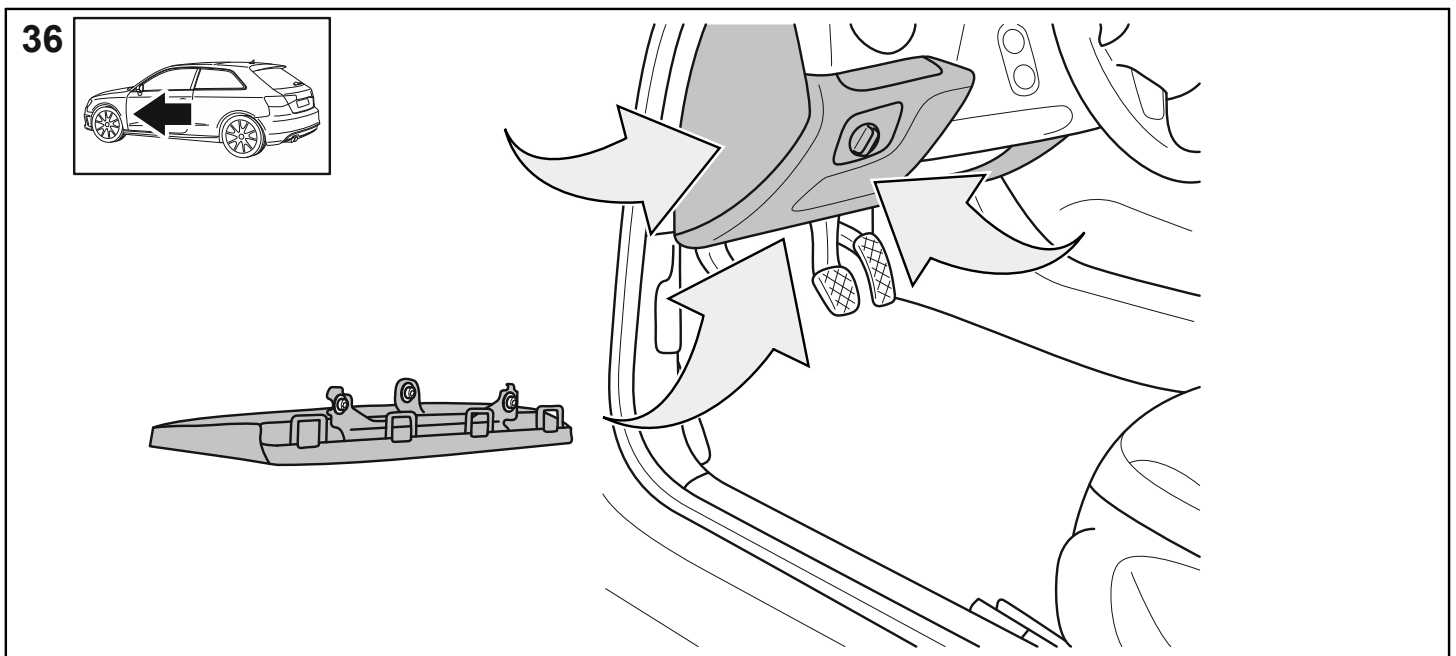
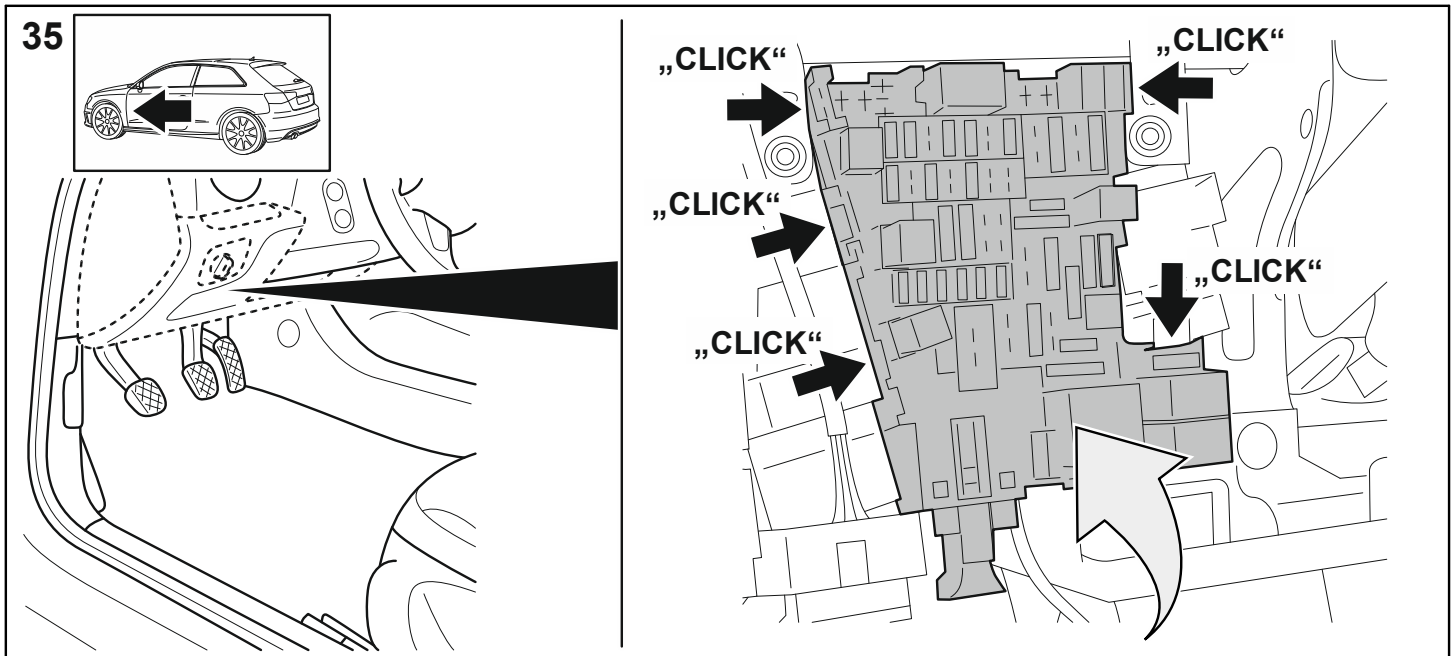

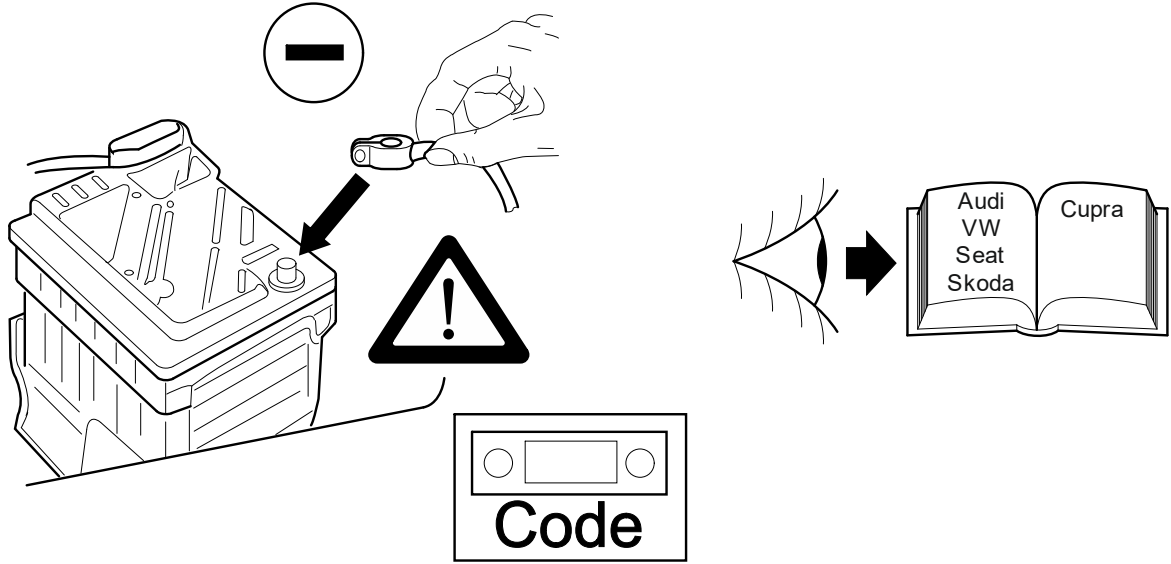

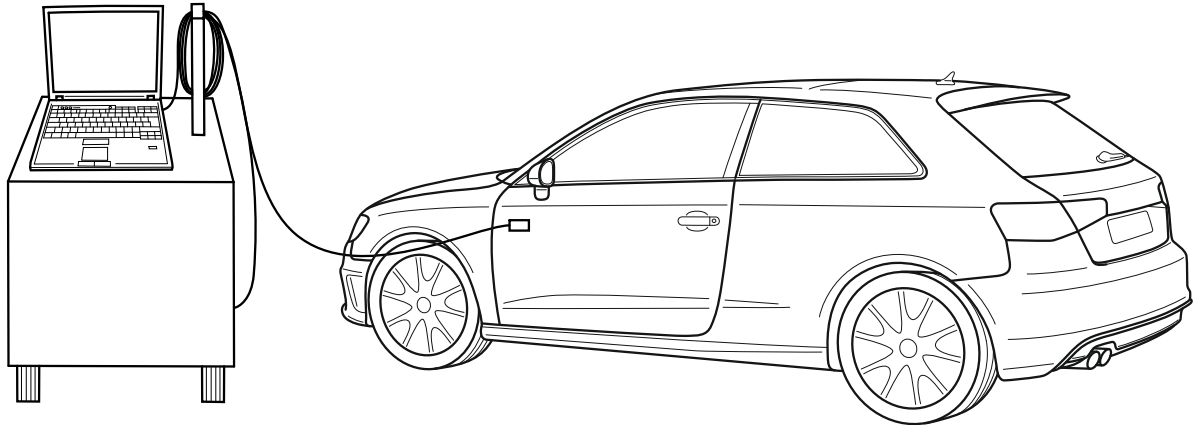

Code



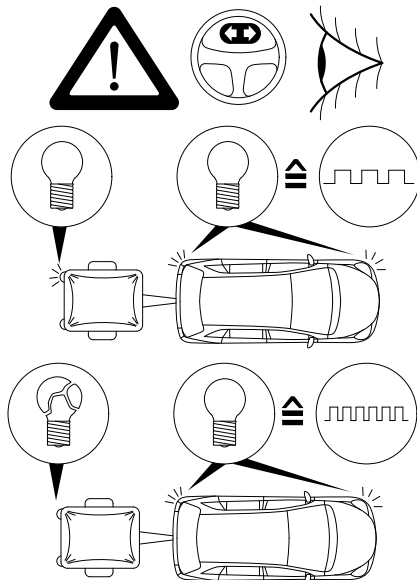
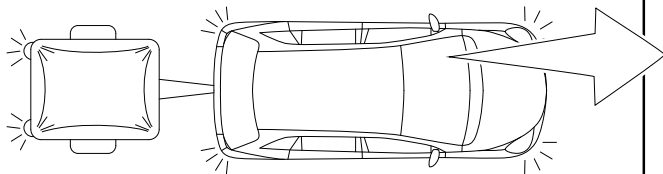

- D** Das Fahrzeug benötigt eine Codierung, jedoch eine online-Kodierung mit dem Maßnahmencode ist nicht mehr möglich.
- CZ** Vozidlo potřebuje kódování, nicméně On-line-kódování s akčním kódem již není možné.
- DK** Køretøjet har brug for en kodning, dog Online-kodning med handlingskode ikke længere er mulig.
- E** El vehículo necesita una codificación, sin embargo La codificación en línea con el código de la acción ya no es posible.
- F** Le véhicule a besoin d'un code, cependant La ligne-codage avec le code d'action est plus possible.
- FIN** Ajoneuvo tarvitsee koodauksen, kuitenkin Online-koodaus toiminnan kanssa koodi ei ole enää mahdollista.
- GB** The vehicle needs a coding, however Online-coding with the action code is no longer possible.
- GR** Το όχημα χρειάζεται κωδικοποίηση, ωστόσο Η σύνδεση-κωδικοποίηση με τον κωδικό δράση δεν είναι πλέον δυνατή.
- HU** A járműnek kódolásra van szüksége, viszont Az online-kódolás a műveleti kód már nem lehetséges.
- I** Il veicolo ha bisogno di una codifica, tuttavia La linea-codifica con il codice di azione non è più possibile
- N** Kjøretøyet trenger en koding, men Den elektroniske-koding med handlingen koden er ikke lenger mulig.
- NL** Het voertuig heeft een codering nodig, echter De online-codering met de actie code niet meer mogelijk.
- PL** Pojazd potrzebuje kodu, jednak Kodowanie online z kodem działania nie jest już możliwe.
- RUS** Автомобилу требуется кодирование, однако Онлайн-кодирование с кодом действий больше не возможно.
- S** Fordonet behöver en kodning, emellertid Online-kodning med åtgärds-koden inte längre är möjlig.

LED  ✓

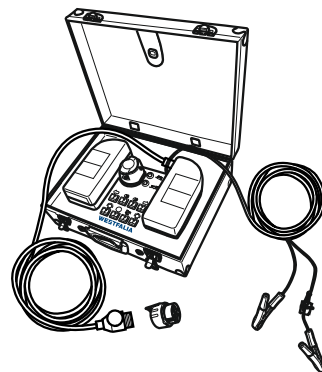

Trailer simulation for carcheck 7-pin and 13-pin
WA no.: 900 001 300 198



LED  ✓

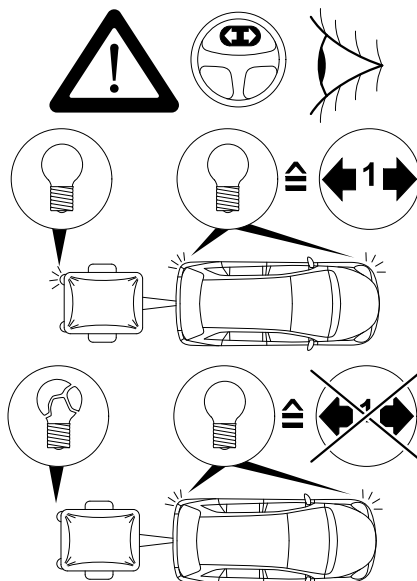
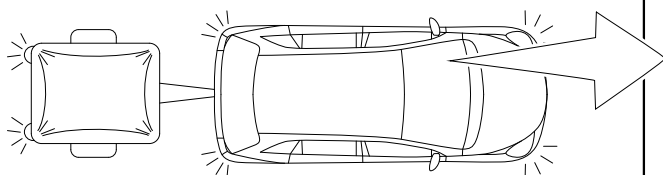

Trailer simulation for carcheck 7-pin and 13-pin
WA no.: 900 001 300 198

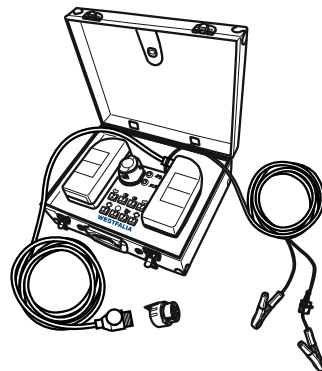

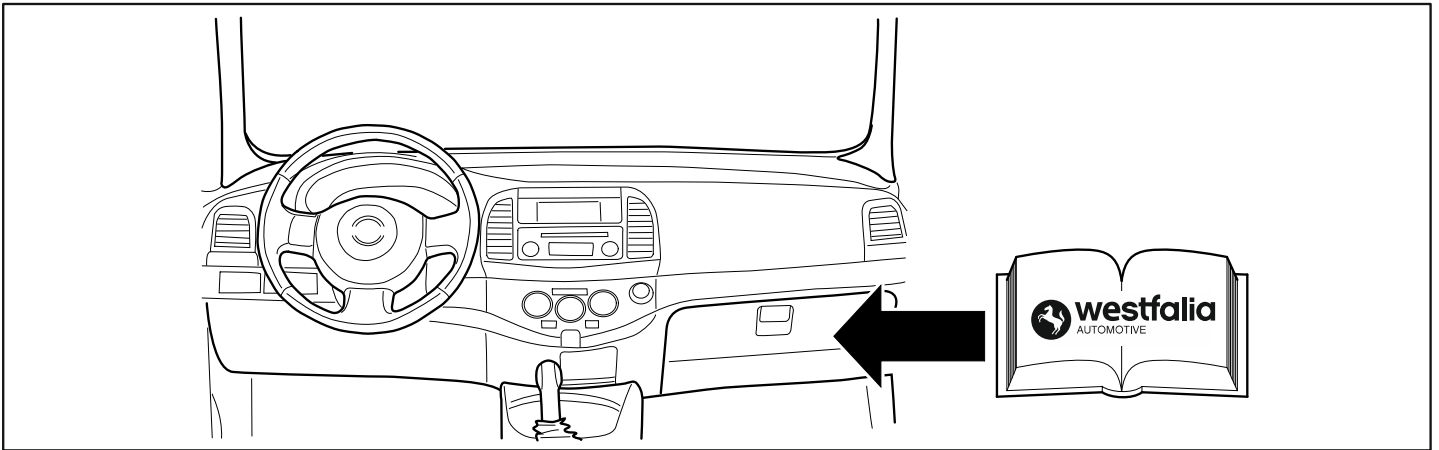





westfalia
AUTOMOTIVE

Optional:
Adapter socket

13-pin 7-pin WA no.: 300 100 320 113

7-pin 13-pin WA no.: 300 100 310 107

<p>7p</p> <p>WA no. 900 001 506 424</p> 	<p>13p</p> <p>WA no. 900 001 506 607</p> 	<p>WA no. 900 001 507 014</p> 	<p>WA no. 900 001 503 924</p> 
--	---	--	---

westfalia
AUTOMOTIVE

Westfalia Cycle Carrier
WA no.: 350 050 600 001

Box
WA no.: 350 002 600 001