



Инструкция по установке  
**RENAULT SANDERO**  
 (2009-2014)



Арт.: F.4714.001





1200 kg

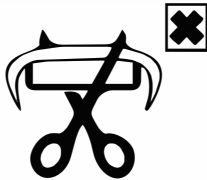

75 kg

D = 6,58 kN

$$D \text{ (kN)} = \frac{\text{MAX kg} \times \text{MAX kg}}{\text{MAX kg} + \text{MAX kg}} \times 0,00981$$



Вкрутить/выкрутить используя инструмент

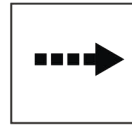

Движение

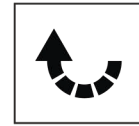

Поворот



Вкрутить/выкрутить не затягивая

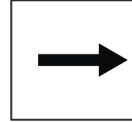





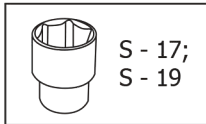
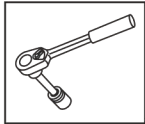



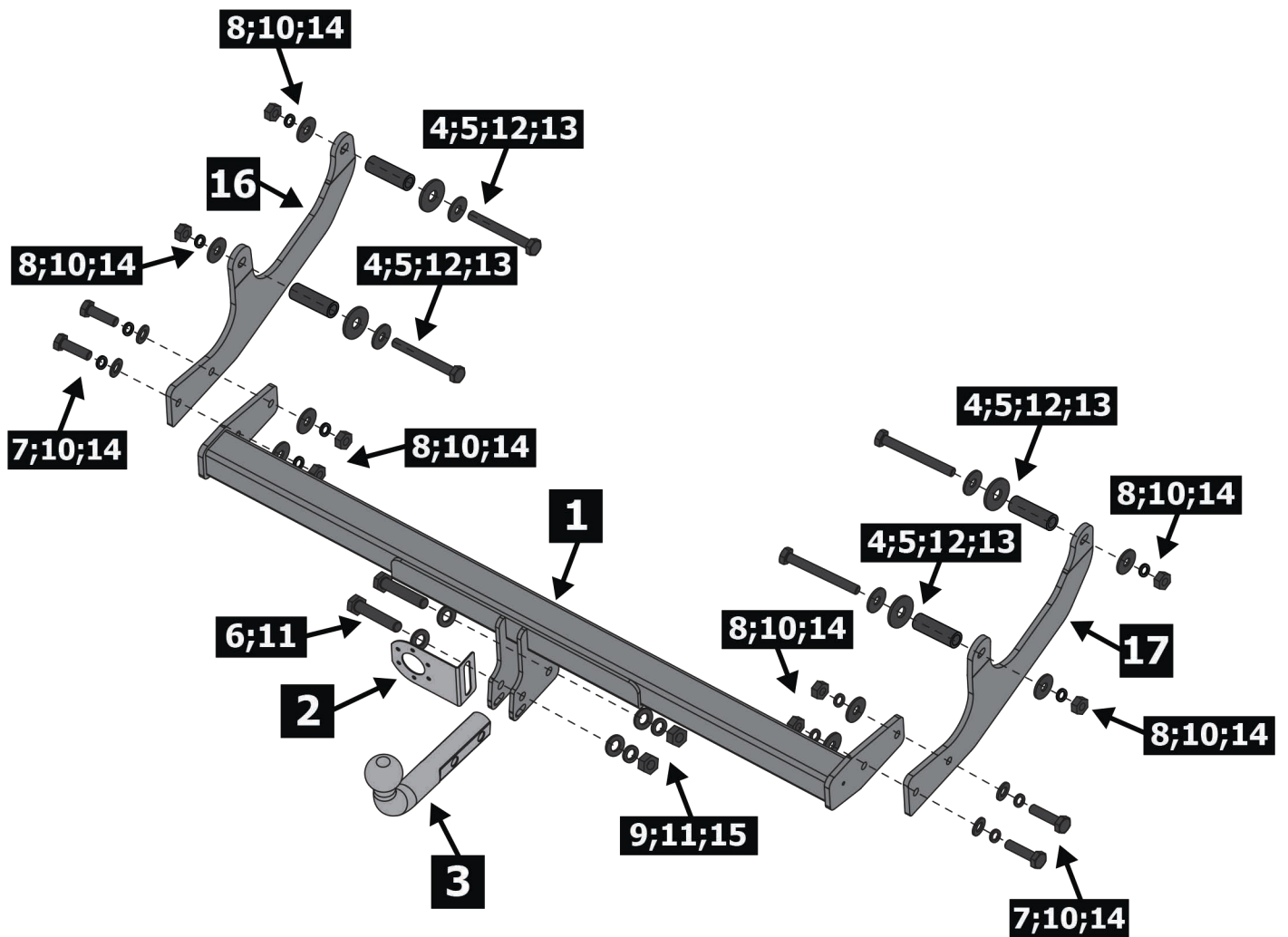

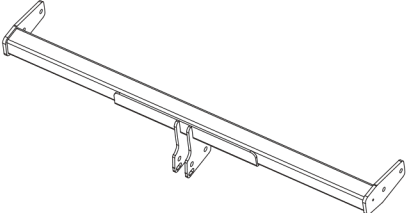
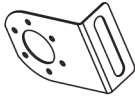
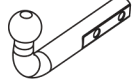

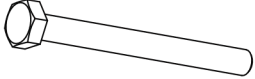

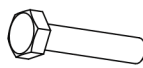
Расположение

## Используемый инструмент:

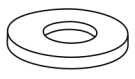
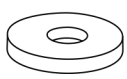

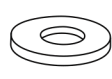
S - 17;  
S - 19



<b>1</b>	x1	Балка	
<b>2</b>	x1	Подрозетник	
<b>3</b>	x1	Крюк	
<b>4</b>	x4	Втулка	
<b>5</b>	x4	M10x90	
<b>6</b>	x2	M12x1.25x70	
<b>7</b>	x4	M10x35	
<b>8</b>	x8	M10	
<b>9</b>	x2	∅ 12	
<b>10</b>	x8	∅ 10	
<b>11</b>	x4	∅ 12	
<b>12</b>	x8	∅ 10	
<b>13</b>	x4	∅ 12	
<b>14</b>	x10	∅ 10	
<b>15</b>	x2	M12x1.25	
<b>16</b>	x1	Кронштейн левый	
<b>17</b>	x1	Кронштейн правый	

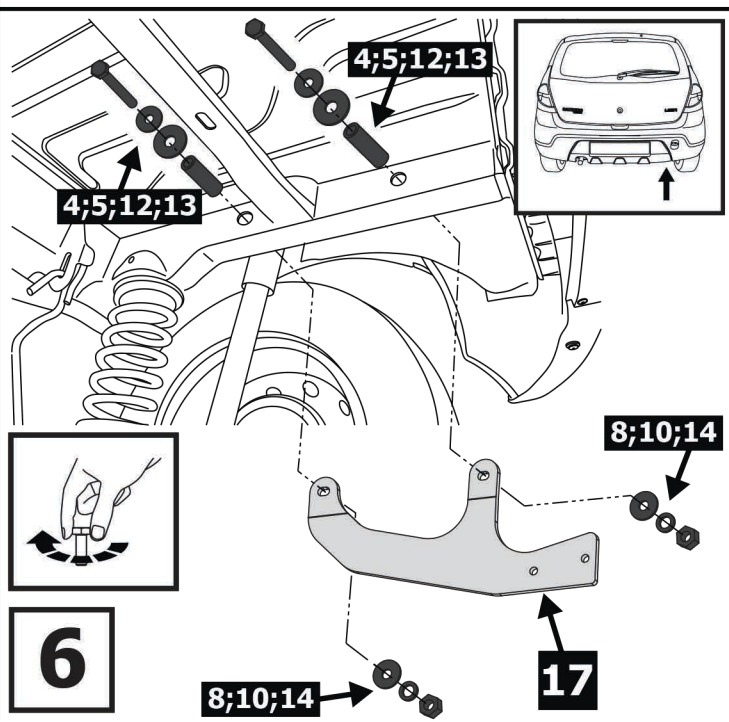
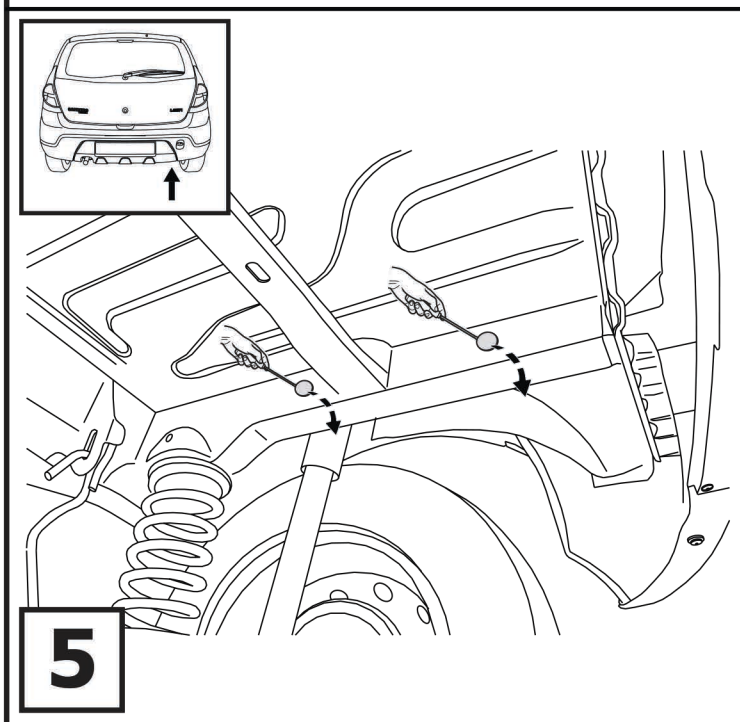
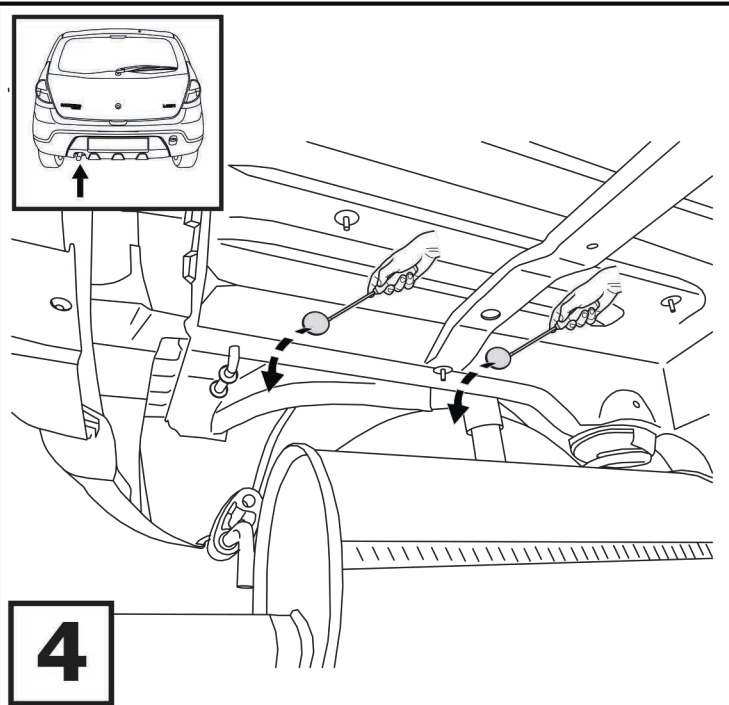
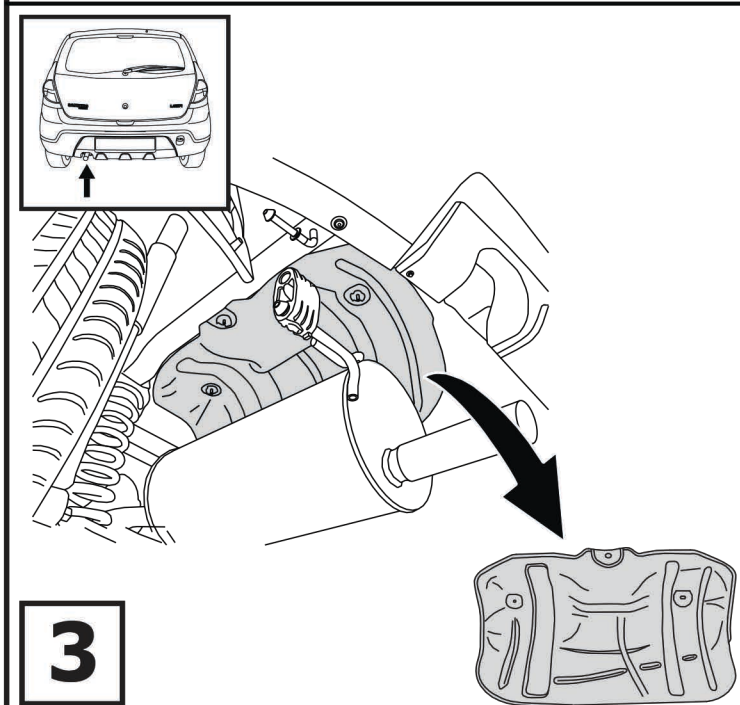
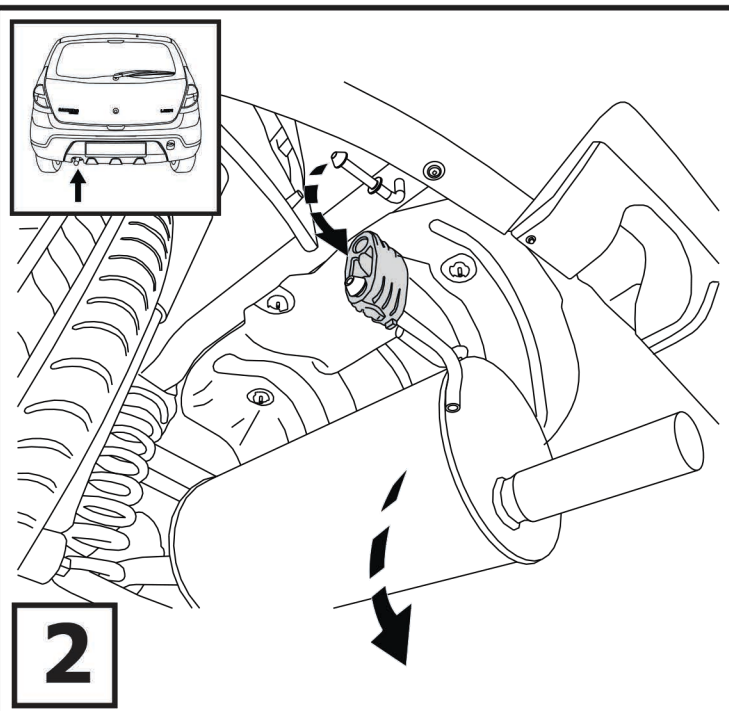
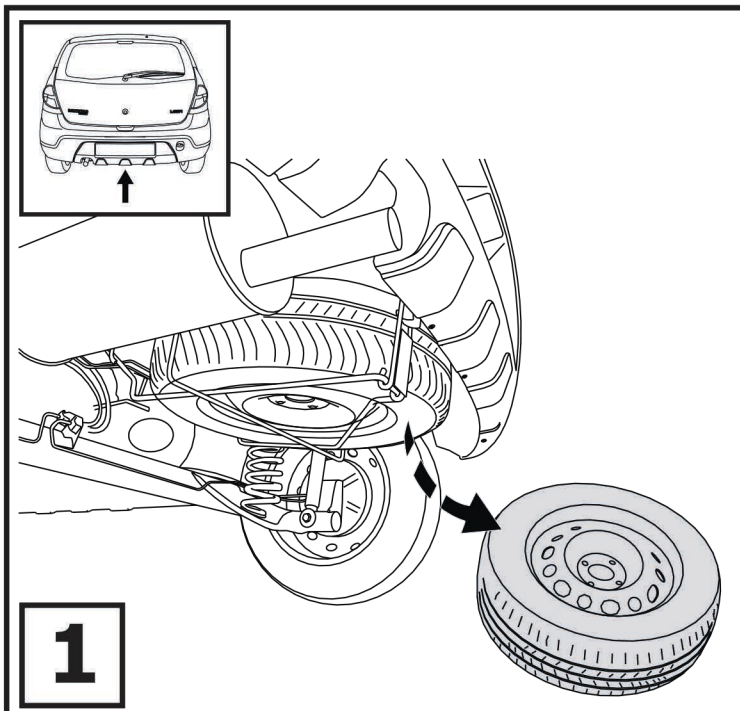



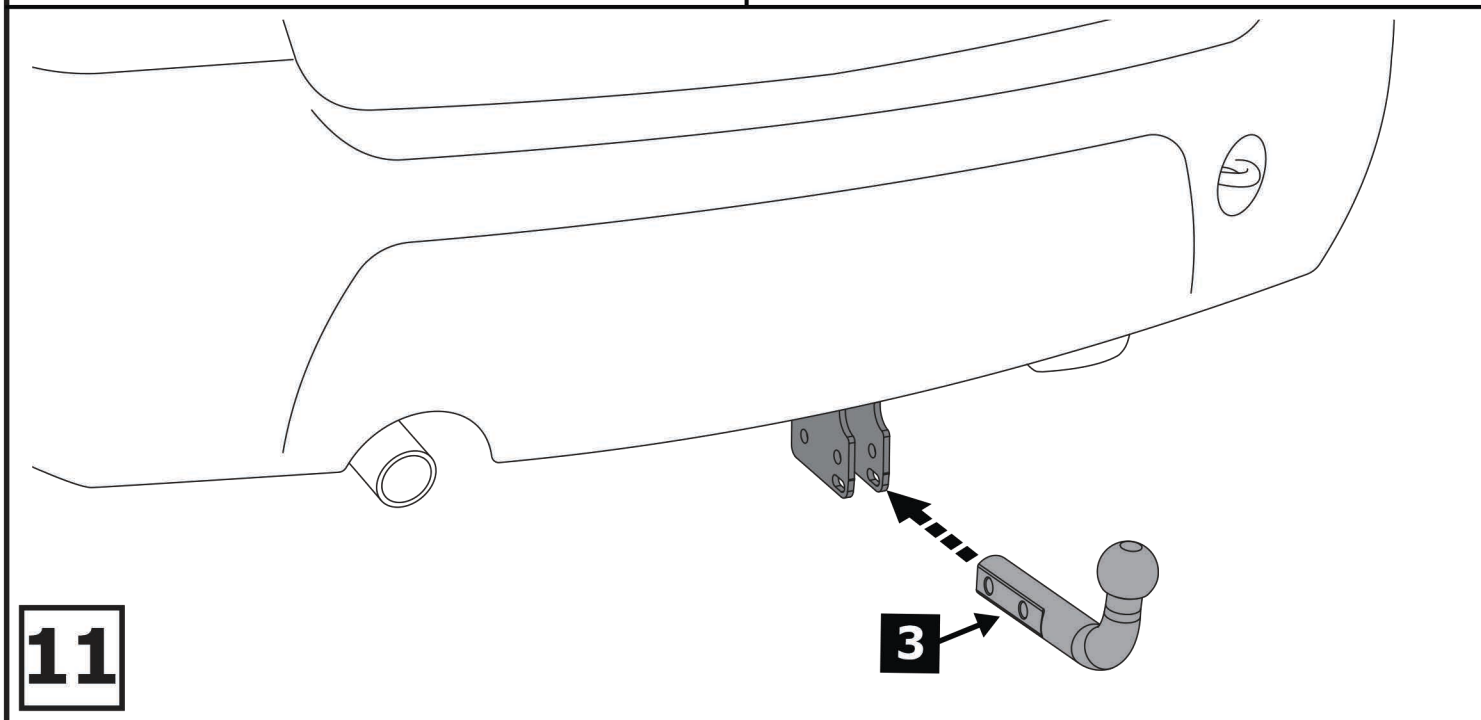
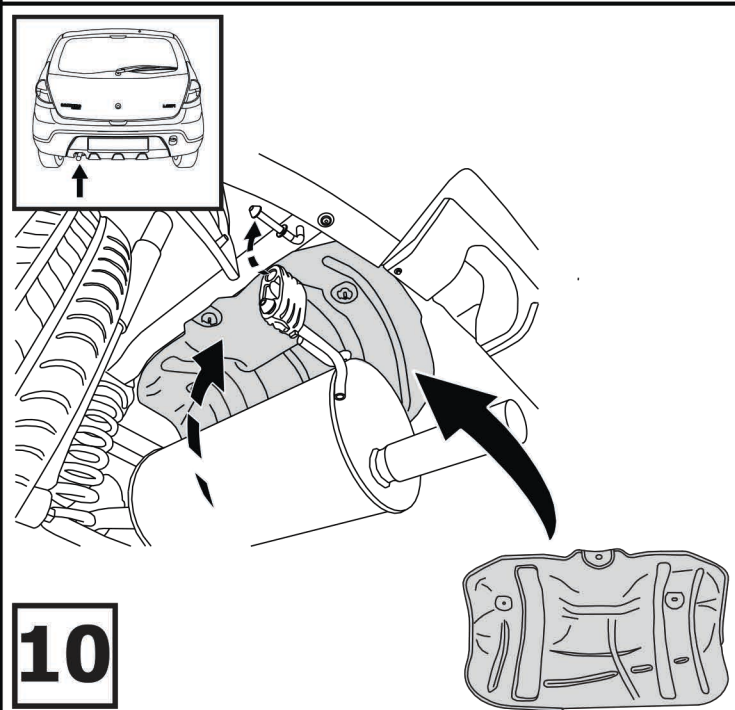
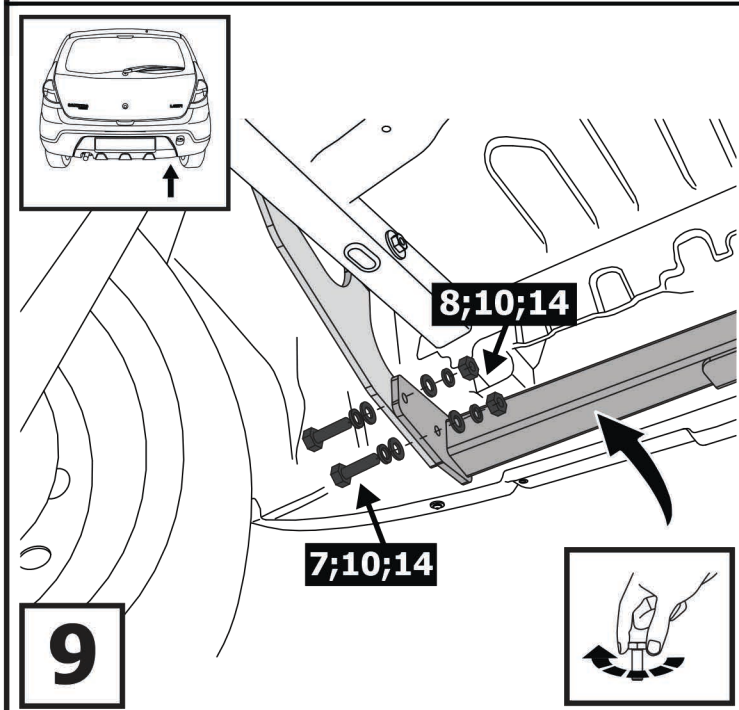
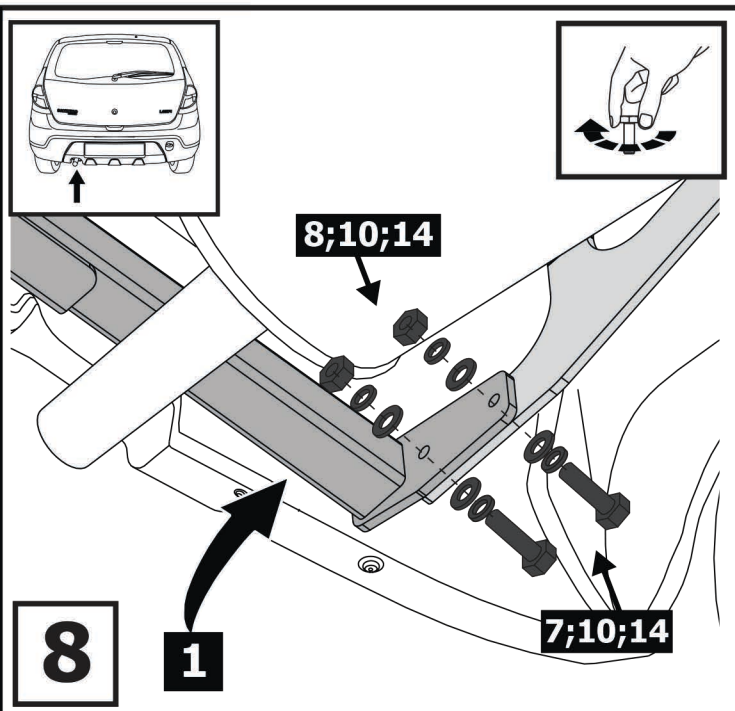
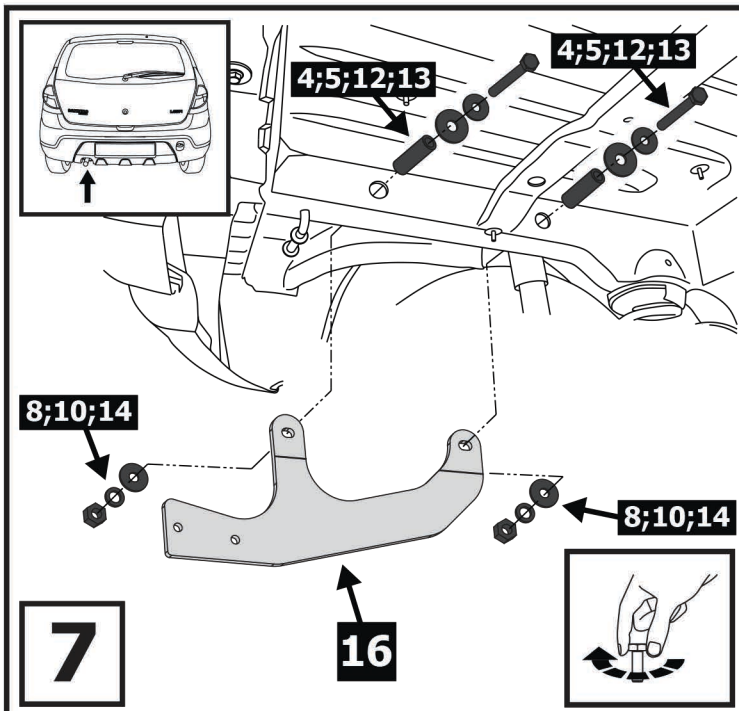



**12**

**6;11**

**2**

**9;11;15**

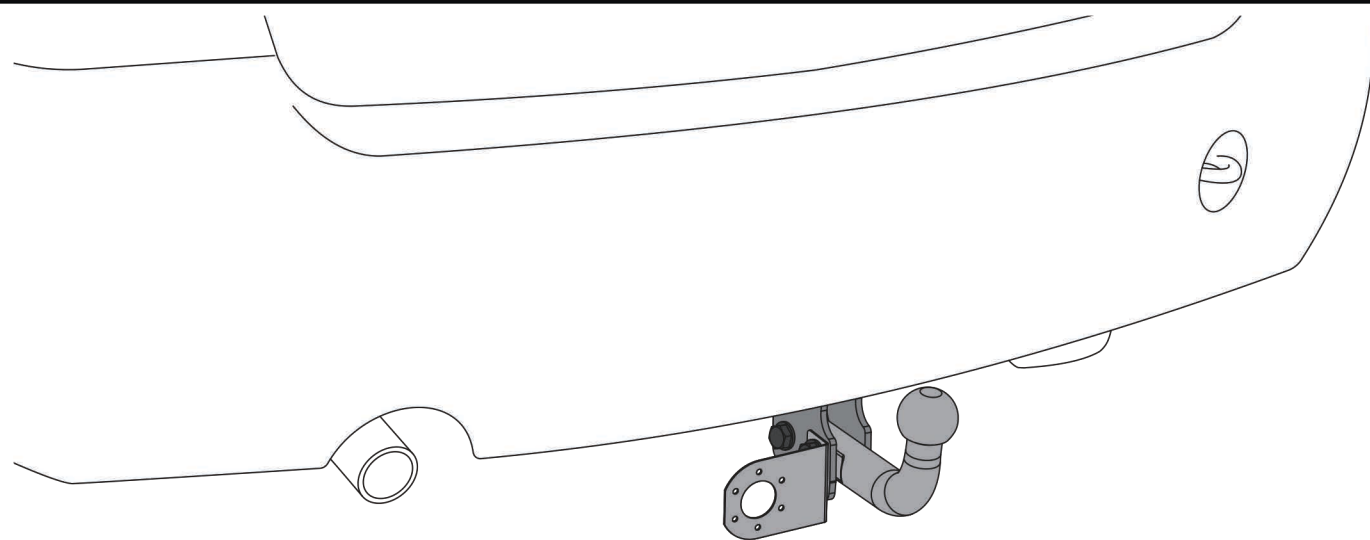

**13**

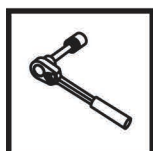

**Затянуть все резьбовые соединения**  
**M10 = 47 Nm    M12 = 84 Nm**