

No. 26250519C TOYOTA

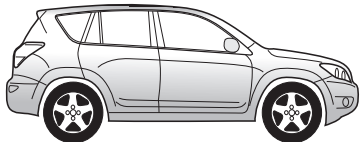

RAV4 5-Türer 02/06 → 03/13
RAV4 5-Door 02/06 → 03/13

ConWys AG

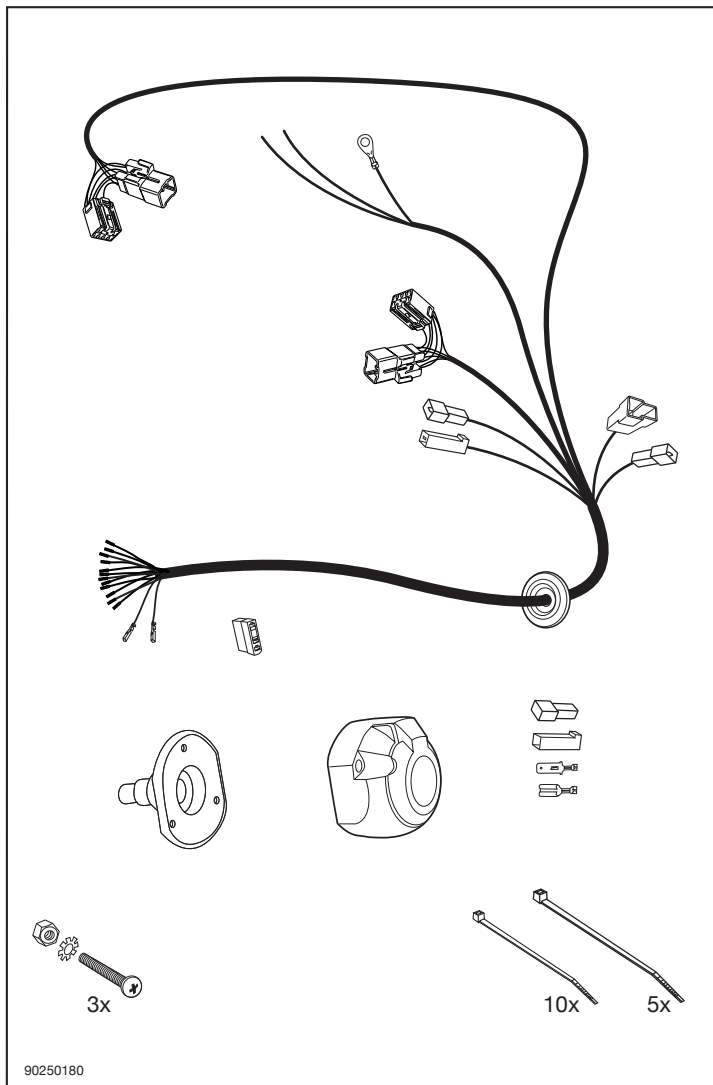
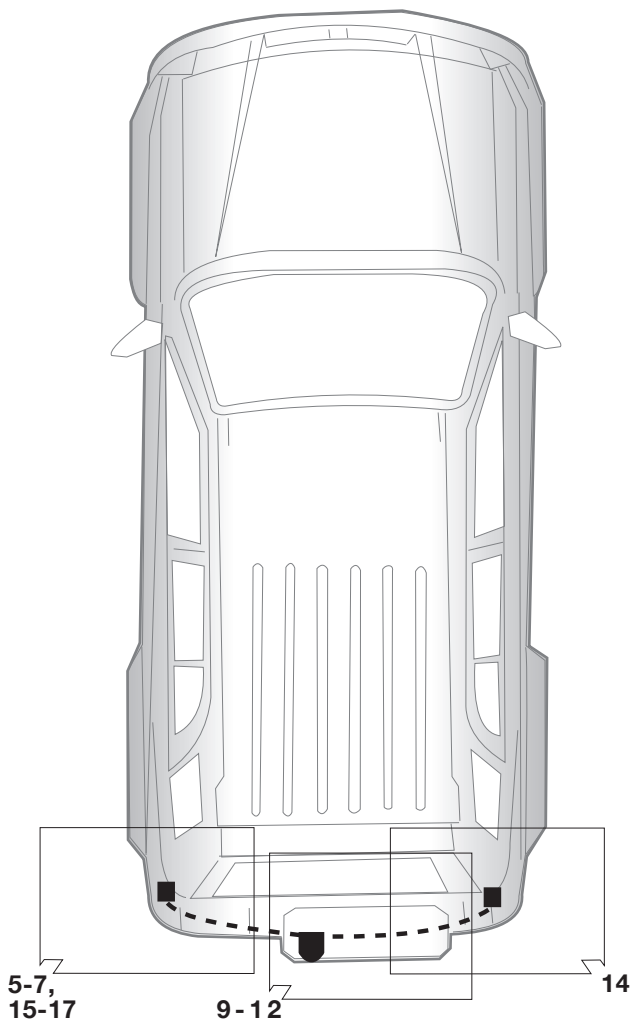

! Der Einbau dieses Elektrosatzes muß von einer Fachwerkstatt oder einer entsprechend qualifizierten Person durchgeführt werden. Vor Beginn aller Montagearbeiten unbedingt die Einbauanleitung komplett durchlesen. Nach Einbau des Elektrosatzes ist die Einbauanleitung den Serviceunterlagen des Fahrzeuges beizulegen!

D Bei unsachgemäßer Anwendung oder Veränderung des Elektrosatzes bzw. der darin befindlichen Bauteile erlischt jeder Anspruch auf Gewährleistung. Beim Fahren ohne Anhänger oder Ladungsträger müssen ggf. verwendete Adapter immer aus der Steckdose entfernt werden. Änderungen bezüglich Konstruktion, Ausstattung, Farbe sowie Irrtum vorbehalten. Alle Angaben und Abbildungen unverbindlich.

Bei Anhängern ohne Nebelschlussleuchte sollte diese nachgerüstet werden.

Für technische bzw. elektronische Änderungen, welche nach erstmaliger Inbetriebnahme des Elektrosatzes vom Fahrzeughersteller durchgeführt werden und beispielsweise zu Fehlfunktionen der Anhängersteckdose oder deren Peripherie führen, übernehmen wir keinerlei Gewährleistung!

! Installation of the towing electric kit must be undertaken by a specialist workshop or an appropriately qualified person. Before starting work, you must read the installation instructions through completely. After installing the towing electric kit, the installation instructions should be kept with the vehicle service documentation.

GB All claims under the guarantee will lapse in case of improper use or modification of the towing electric kit or any of its component parts. When driving without a trailer or load carrier, any adapter installed must be removed from the electrical socket. We reserve the right to alter the design, content or colour. We accept no liability for any errors in these instructions. All details and illustrations are non-binding.

In case of missing a rear fog lamp on the trailer, it should be retrofitted.

We accept no responsibility and give no guarantee for technical and electrical modifications made after the initial operation of the towing electric kit by the vehicle manufacturer and which may lead, for example to malfunction of the trailer socket or its peripheries.

! Le montage du kit de connexion électrique doit être effectué par un atelier spécialisé ou par une personne qualifiée en la matière. Avant le début des travaux, lire impérativement les instructions de montage dans leur intégralité. Après le montage du kit de connexion électrique, joindre les instructions de montage aux documents du véhicule.

F Un usage inapproprié ou des modifications du kit de connexion électrique, ou des pièces qui le composent, entraînent l'expiration de tout droit à la garantie. Lors d'une conduite sans remorque ou porteur de charge, les adaptateurs utilisés doivent, le cas échéant, toujours être enlevés de la prise de courant. Sous réserve de modifications de constructions, équipement, couleurs ou erreur. Données et illustrations sous toute réserve.

Pour les remorques qui ne sont pas équipés avec feux anti-brouillard arrière, il devrait être installé.

Nous n'assumons aucune responsabilité ni garantie pour les modifications techniques et électroniques ayant été effectuées après la première mise en service du kit de connexion électrique par le constructeur automobile et ayant mené par exemple à des mauvais fonctionnements de la prise de remorque ou de sa périphérie.

! L'installazione del kit elettrico deve essere effettuata da un'officina o da personale specializzato. Prima di iniziare tutti i lavori di montaggio, leggere da cima a fondo le istruzioni. Dopo aver installato il kit elettrico si prega di allegare le istruzioni di montaggio ai documenti di manutenzione del veicolo!

I In caso di uso improprio o di modifiche del kit elettrico e delle componenti del medesimo, ogni diritto di garanzia decade. Durante la guida senza rimorchio o portacarichi, togliere sempre gli adattatori dalla presa di corrente. Con riserva di modifiche relative a costruzione, equipaggiamento, colore e salvo errori. Tutte le indicazioni e illustrazioni non sono vincolanti.

In caso di rimorchi non corredati di luce retronebbia, questa dovrebbe essere installata.

Per le modifiche tecniche ed elettroniche eseguite dopo la prima messa in funzione del kit elettrico da parte del costruttore del veicolo, e che portano, per esempio, a un malfunzionamento della presa del rimorchio o della sua periferia, non ci assumiamo alcuna responsabilità!

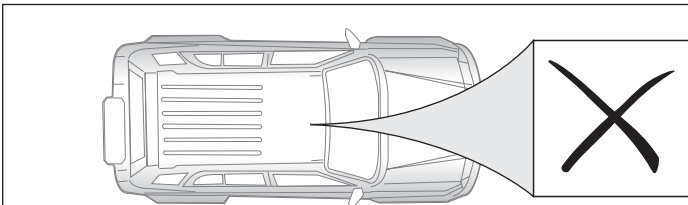
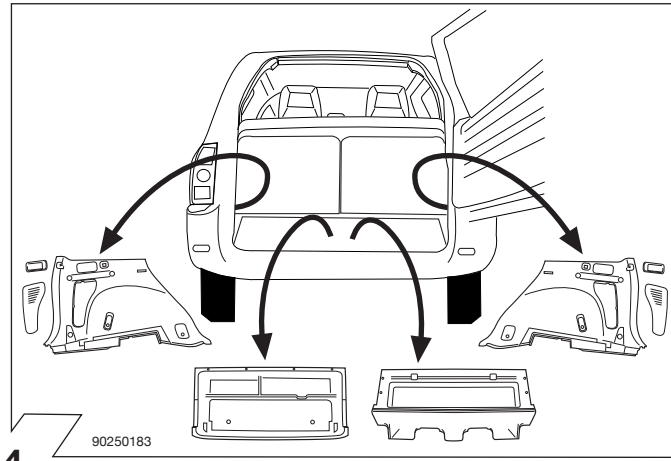
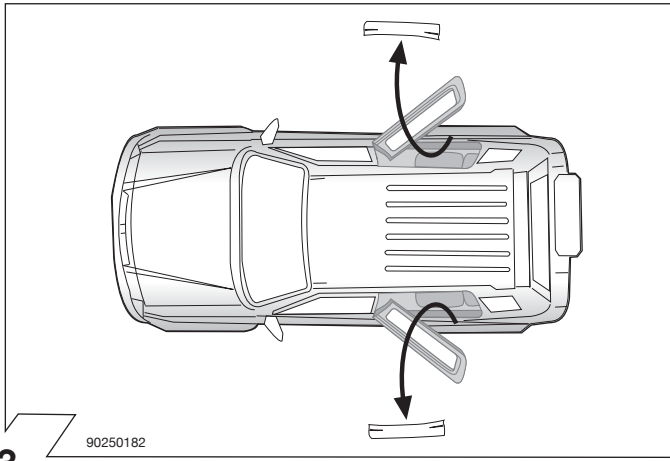
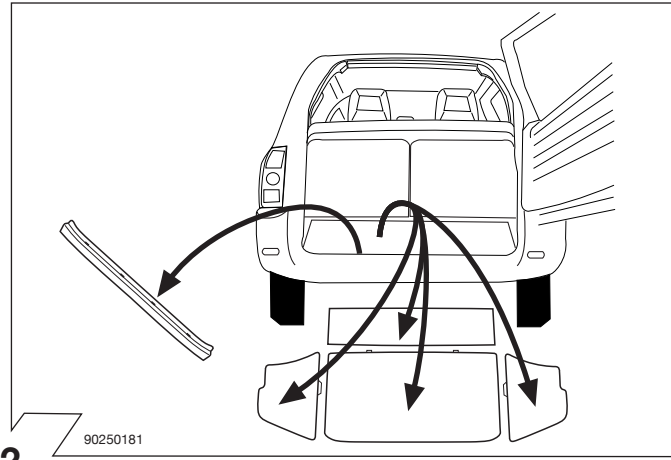
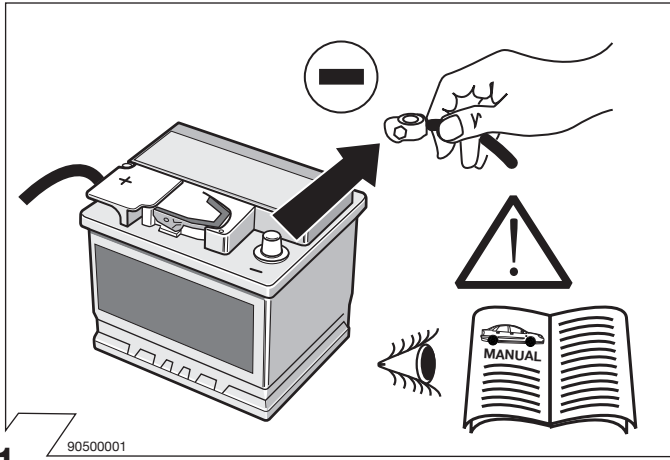

6,
8 - 24

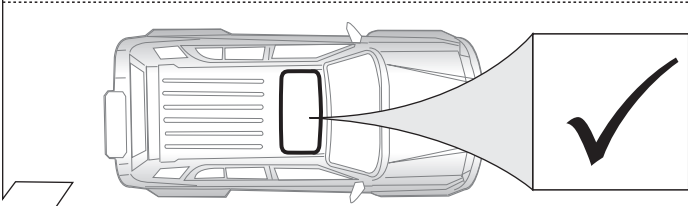

7- 24

5

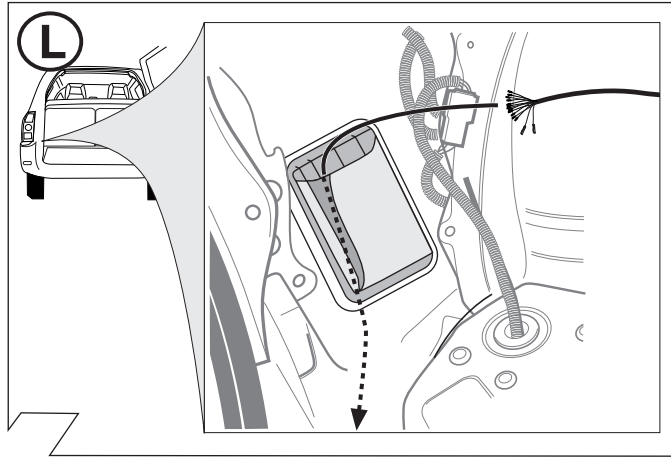
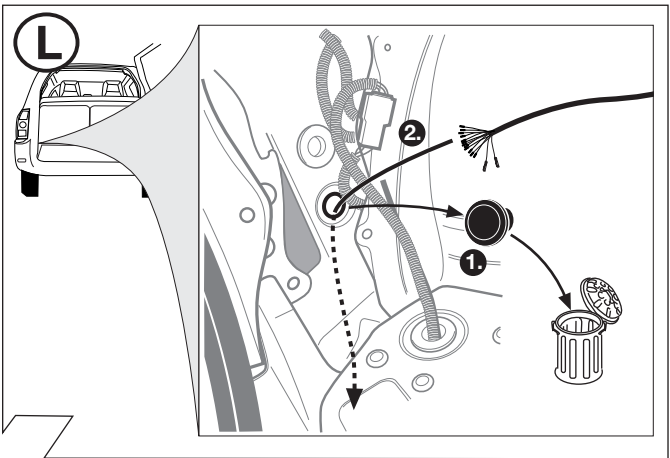

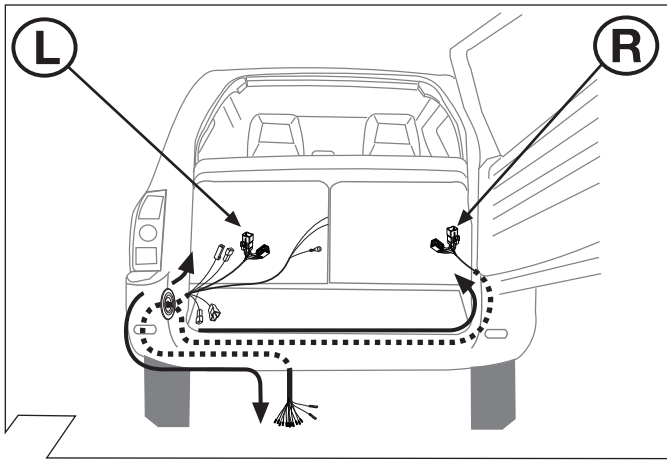

8

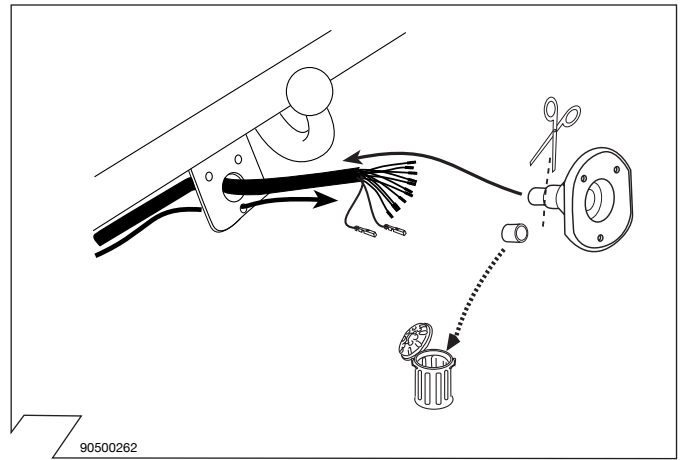

9

| ISO 11446 | Belegung der Steckdose / Maximale Ausgangsleistung Socket configuration / Maximum power output Correspondance des contacts de la prise / Puissance de sortie maximale Abbinamento della presa / Uscita di alimentazione massima Indeling van de stekkerdoos / maximaal uitgangsvermogen | | |
|-----------|---|-----------------|-----------------|
| | 1/L | BK/WT | 21W |
| | 2 | WT | 42W |
| | 2a | BK | XXXX |
| | 3/31 | BR | XXXX |
| | 4/R | BK/GN | 21W |
| | 5/58-R | GY/RD | 52W |
| | 6/54 | BK/RD | 63W |
| | 7/58-L | GY/BK | 52W |
| | 8 | BL/RD | 42W |
| | 9 | RD | 240W |
| | 10 | YL | 180W |
| | 11 | YL/BR | XXXX |
| | 12 | XXXX | XXXX |
| | 13 | RD/BR | XXXX |

10

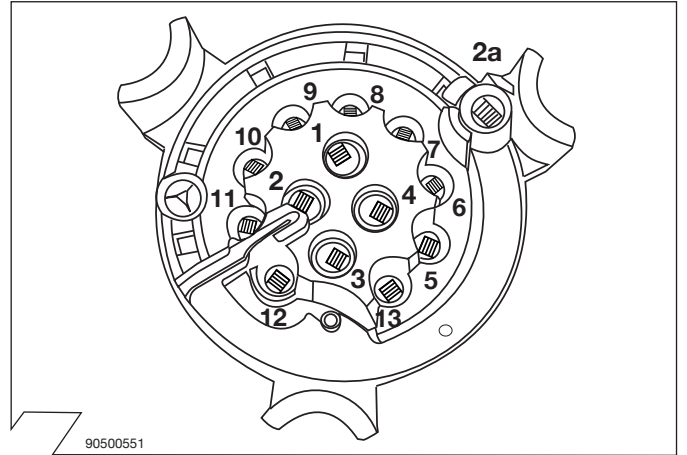

11

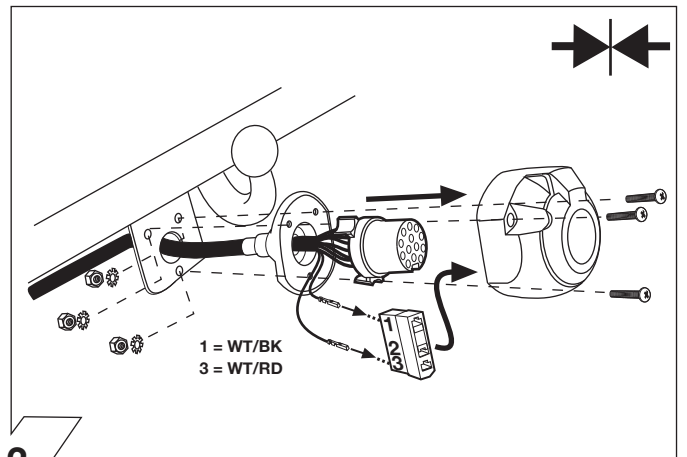

12

| | GB | D | E | F | I | P | NL | DK | N | S | FIN | CZ | H | PL |
|----|--------|---------|----------|--------|-----------|-------------|--------|--------|---------|---------|-----------|----------|-----------|--------------|
| BK | Black | Schwarz | Negro | Noir | Nero | Preto | Zwart | Sort | Svart | Svart | Musta | Černá | Fekete | Czarny |
| RD | Red | Rot | Rojo | Rouge | Rosso | Vermelho | Rood | Rød | Röd | Röd | Punainen | Červená | Piros | Czerwony |
| GN | Green | Grün | Verde | Vert | Verde | Verde | Groen | Grøn | Grønt | Grön | Vihreä | Zelená | Zöld | Zielony |
| OR | Orange | Orange | Naranja | Orange | Arancione | Laranja | Oranje | Orange | Orange | Orange | Oranssi | Oranzová | Narancs | Pomarańczowy |
| VT | Violet | Violett | Violeta | Violet | Viola | Violeta | Violet | Violet | Fiolett | Violett | Violetti | Fialová | Ibolya | Fioletowy |
| PK | Pink | Pink | Pink | Rose | Rosa | Cor-de-Rosa | Paars | Pink | Pink | Rosa | Pinkki | Růžová | Rózsaszín | Różowy |
| BL | Blue | Blau | Azul | Bleu | Blu | Azul | Blauw | Blå | Blått | Blá | Sininen | Modrá | Kék | Niebieski |
| YL | Yellow | Gelb | Amarillo | Jaune | Giallo | Amarelo | Geel | Gul | Gult | Gul | Keltainen | Zlutá | Sárga | Żółty |
| WT | White | Weiss | Blanco | Blanc | Bianco | Branco | Wit | Hvid | Hvitt | Vit | Valkoinen | Bílá | Fehér | Biały |
| BR | Brown | Braun | Marrón | Brun | Marrone | Marrom | Bruin | Brun | Brunt | Brun | Ruskea | Hnědá | Barna | Brazowy |
| GY | Grey | Grau | Gris | Gris | Grigio | Cinzeno | Grijs | Grå | Grått | Grå | Harmaa | Sedá | Szürke | Szary |

13

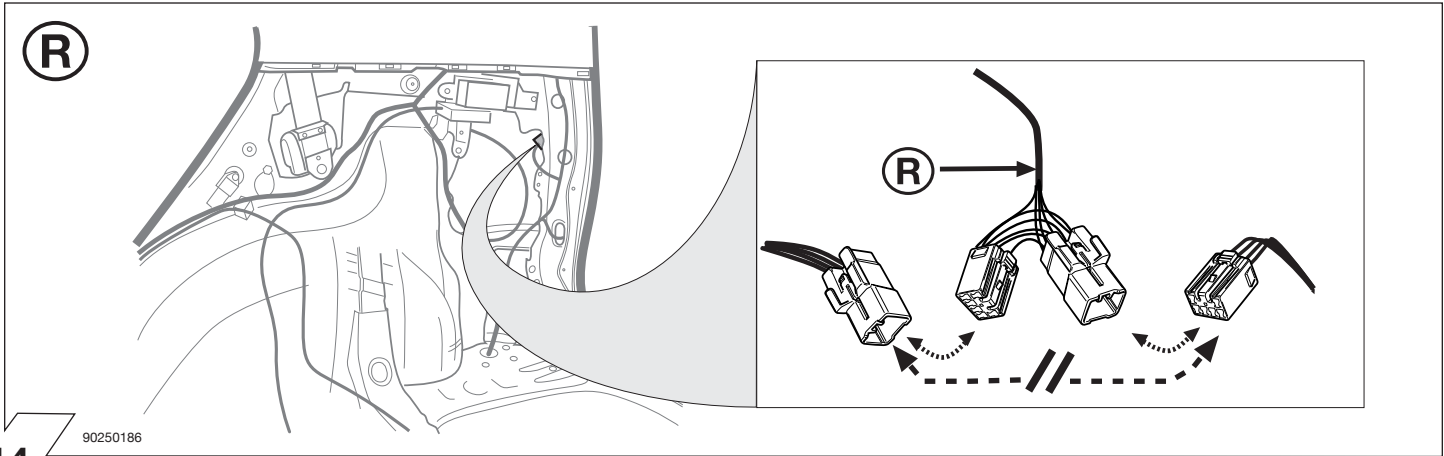

14

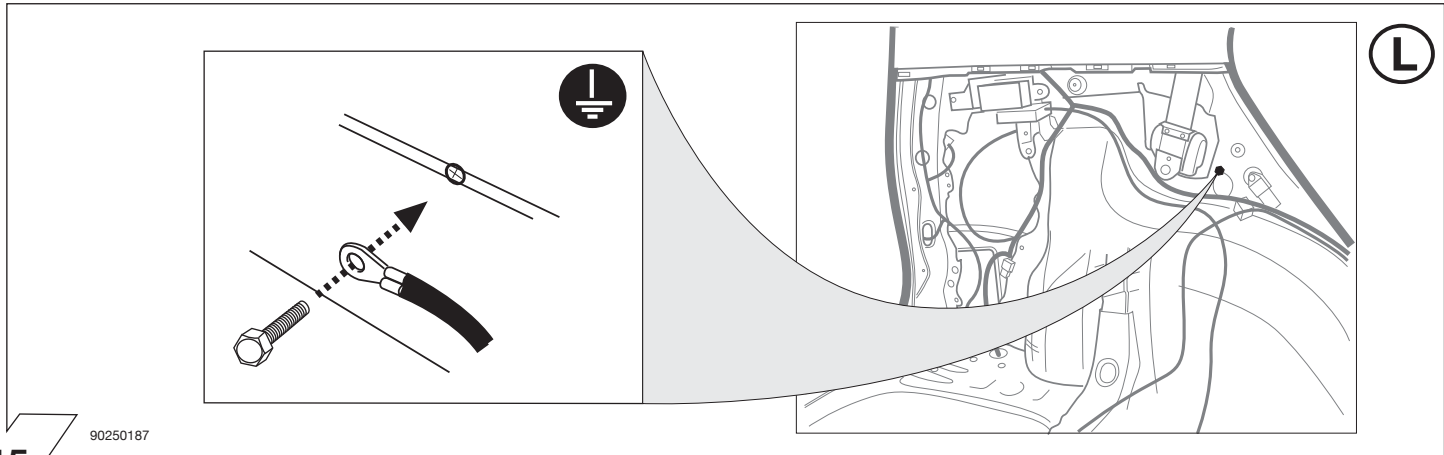

15

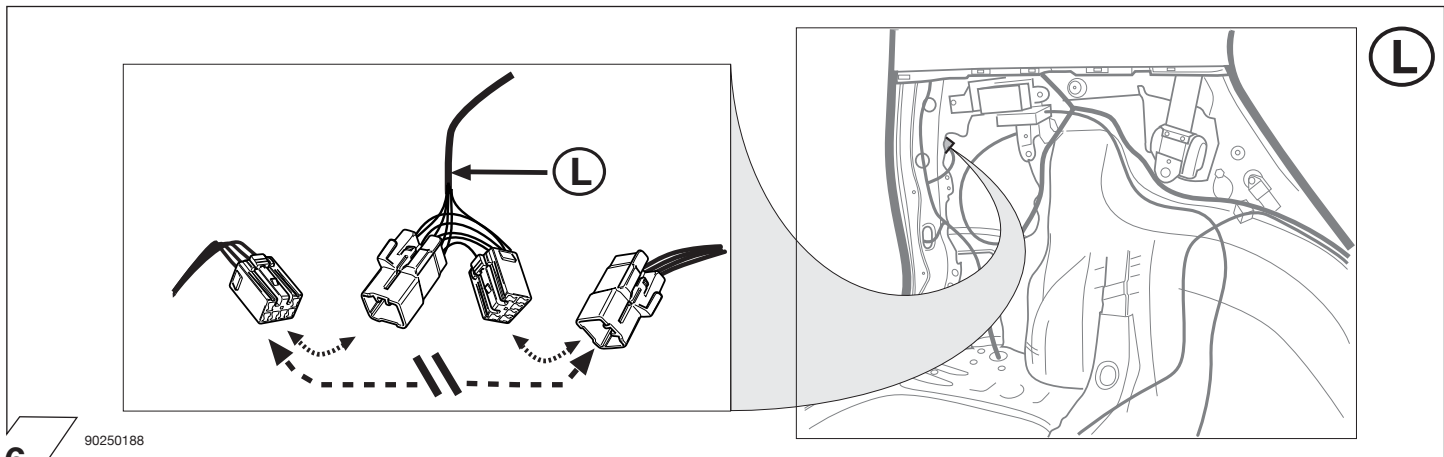

16

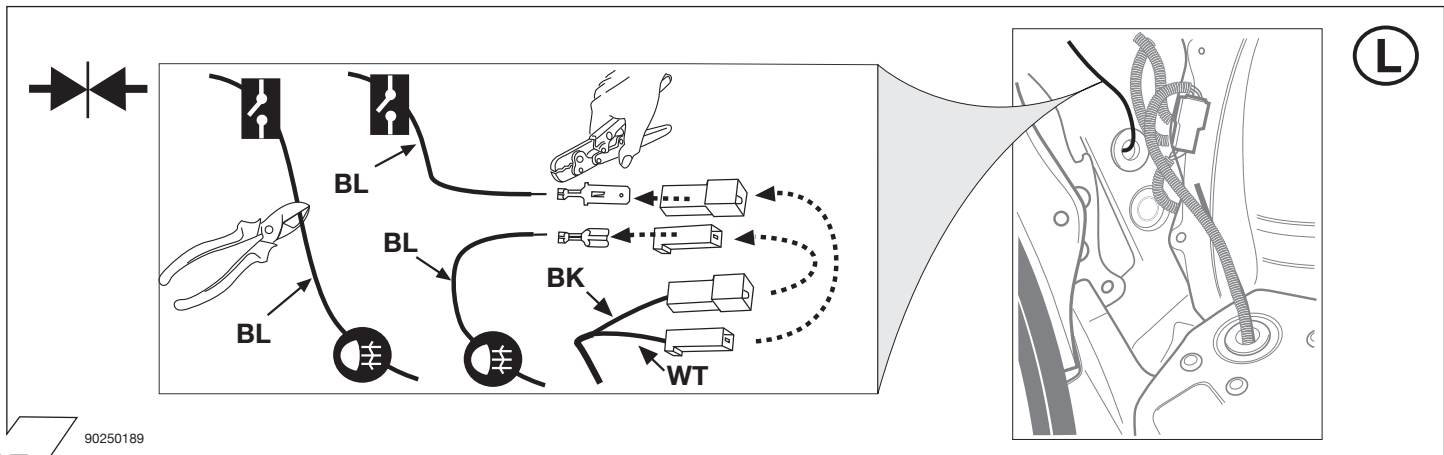

17

OPTIONAL PDC cut-off

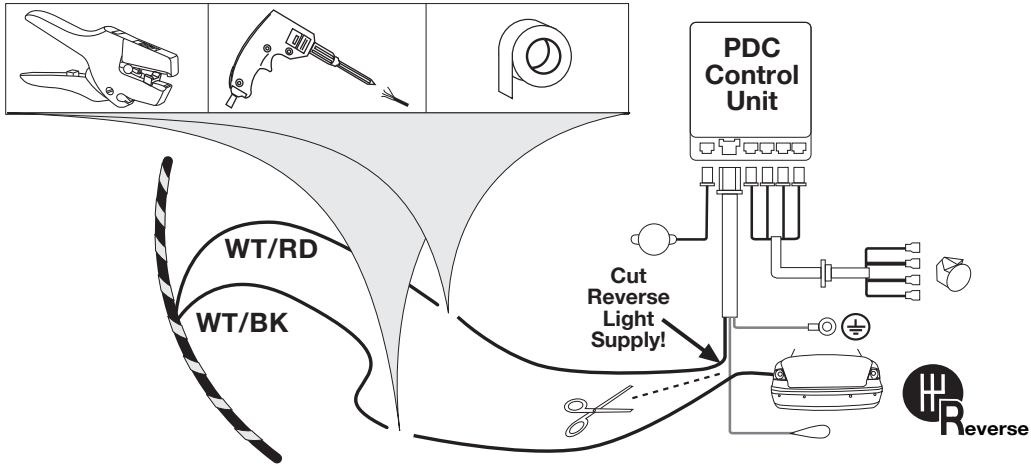
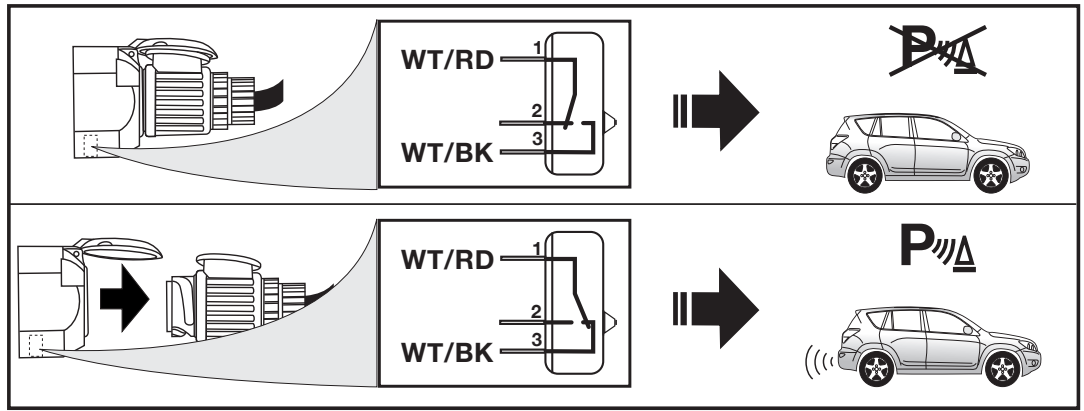
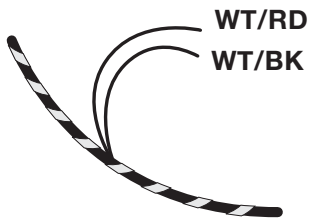

90500710

18

OPTIONAL

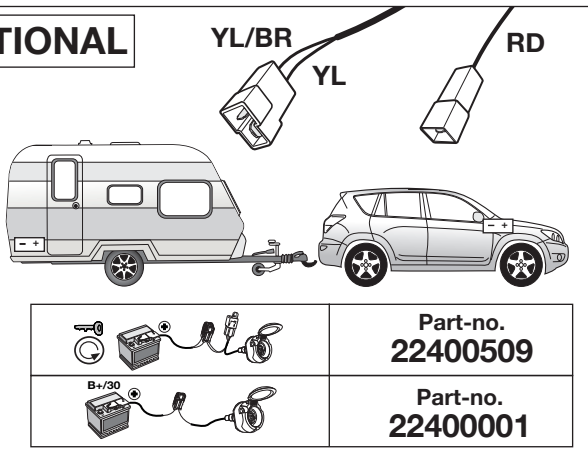

19

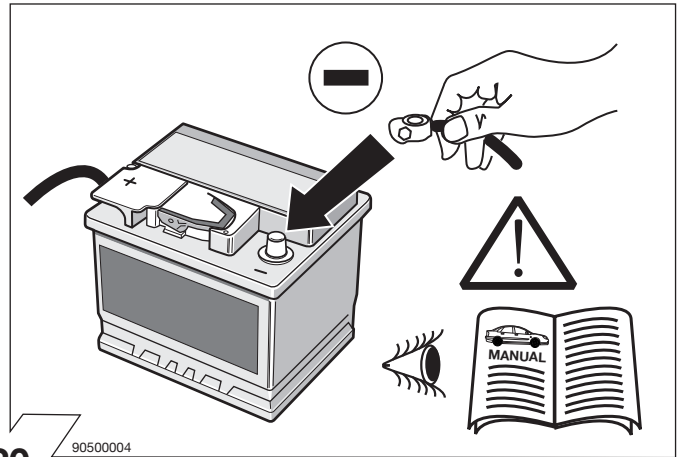

20

OPTIONAL

**Trailer Simulator
for 7- and 13-pin
Sockets**

Part-no.
50400516C

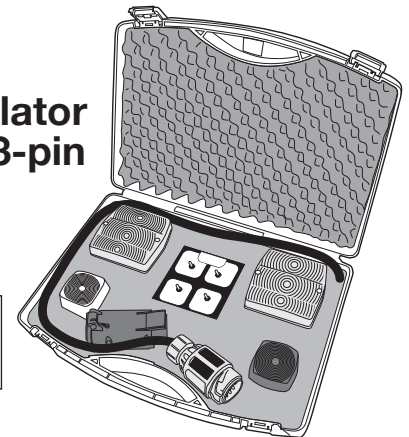

22

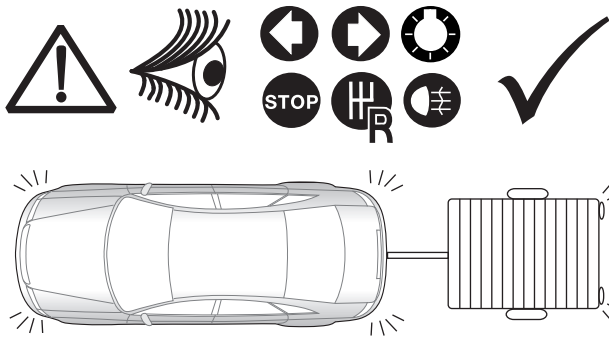

21

90500507



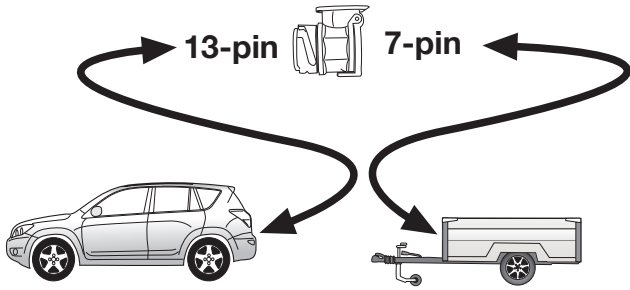



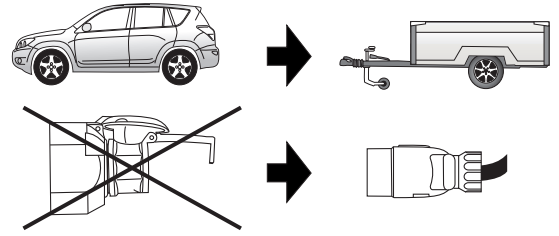





















Optional: Adapter socket 62400003



23



24

| ERKLÄRUNG SYMBOLE | SYMBOL EXPLANATION | EXPLICATION DES SYMBOLES | SPIEGAZIONE DEI SIMBOLI | EXPLICACIÓN DE LOS SIMBOLES | VERKLARING SYMBOLEN |
|---|--|--|---|---|---|
| (D) | (GB) | (F) | (I) | (E) | (NL) |
|  | left (58-L) respectively right (58-R) tail light | feu arrière gauche (58-L) respectivement droite (58-R) | luce posteriore sinistra (58-L) rispettivamente destra (58-R) | plato trasero izquierdo (58-L) respectivamente derecho (58-R) | Linker (58-L) c.q. rechter (58-R) achterlicht |
|  | high mounted, third stop light (54) | 3ème feu de stop (54) | luce d'arresto (54) / 3. luce d'arresto (54) | tercera luz de freno (54) | Remlicht (54) / 3e remlicht (54) |
|  | turn signal indicator left | feu indicateur de direction gauche | indicatore di direzione sinistra | luz indicadora de dirección de marcha izquierda | Richtingaanwijzer links |
|  | turn signal indicator right | feu indicateur de direction droite | indicatore di direzione destra | luz indicadora de dirección de marcha derecha | Richtingaanwijzer rechts |
|  | rear fog light(s) | feu (x) arrière (s) de brouillard | fendinebbia | luz (-ces) trasera (s) antineblia (s) | Mistachterlicht(en) |
|  | reversing light(s) | feu (x) de marche arrière | luce (i) retromarcia | luz (-ces) de marcha atrás | Achteruitrijlicht(en) |
|  | Permanent power supply / 13pin socket, chamber 9 | courant continué / prise de courant à 13 pôles, compartiment 9 | alimentazione continua / presa 13 poli, camera 9 | positivo continuo / caja de anclure a 13 polos, cámara 9 | Continuustroom / stekkerdoos 13P kamer 9 |
|  | charging wire for trailer battery / 13pin socket, chamber 10 | cable de charge / prise de courant à 13 pôles, compartiment 10 | cavo di carica / presa 13 poli, camera 10 | cable de carga / caja de anclure a 13 polos, cámara 10 | Laaddraad / stekkerdoos 13P kamer 10 |
|  | trailer recognition | détection de la fonction "remorque" | rimorchio / riconoscimento rimorchio | remolque / detección del remolque | Aanhanger / aanhangeridentificatie |
|  | Permanent current power supply | courant continue / alimentation électrique permanente | corrente / alimentazione continua | positivo continuo / alimentación de corriente permanente | Continuustroom / permanente stroomvoorziening |
|  | Ground or Earth (31) | masse (31) | masse (31) | masa (31) | Massa (31) |
|  | ground connection battery terminal lug | borne "moins" de la batterie | connessione negativa della batteria | conexión negativa de batería | Accupoolkiem aansluiting min |
|  | positive connection battery terminal lug | borne "plus" de la batterie | connessione positiva della batteria | conexión positiva de batería | Accupoolkiem aansluiting plus |
|  | fuse / fuse capacity 20 Ampère | ampérage 20 ampères | fusibile / fusibile con capacità 20 Ampère | fusible / amperaje 20 amperes | Zekering / zekeringsterkte 20 Ampère |
|  | cigarette lighter / accessory socket | allume-cigare / prise d'accessoires | accendisigari / presa accessori | encendido de cigarillos / caja de accesorios | Sigarettenaanstekker / accessoire stekkerdoos |
|  | loudspeaker / buzzer | haut-parleur / vibreur | autoparlante / cicalino | altavoz / señal acustica de advertencia | Luidspreker / waarschuwingszoemer |
|  | park distance control | assistance au parking | sensori di parcheggio | ayuda para aparcar | Inparkeerhulp |
|  | switch / source of function | interrupteur / origine de fonction | interruttore / origine funzione | interruptor / origen de función | Schakelaar / functieoorsprong |
|  | Connect together | raccorder | connessione | conectar | Koppelen |
|  | disconnect | séparer | sconnessione | separar | Ontkoppelen |
|  | Look at / see further information | considérer / voir informations ultérieures | considerare / vedere ulteriori informazioni | considerar / véase las informaciones | Let op / bekijk verdere informatie |
|  | look carefully at selected area | faire attention à la zone sélectionnée | considerare area selezionata | considerar el área seleccionada | Let op gekozen bereik |
|  | Present / Occupied / OK | disponible / occupé / OK | presente / occupato / OK | presente / ocupado / OK | Aanwezig / bezet / i.o. |
|  | Not present / Not occupied / not OK | pas disponible / pas occupé / pas OK | non presente / non occupato / non OK | non presente / non ocupado / non OK | Niet aanwezig / niet bezet / niet i.o. |
|  | left | gauche | sinistra | izquierdo | Links |
|  | right | droite | destra | derecho | Rechts |
|  | acoustic indication | signalisation acoustique | segnalazione acustica | señalización acústica | Akoestische signalering |
|  | attention / important advice | attention / indication importante | attenzione / indicazione importante | atención / indicación importante | Attentie / belangrijke instructie |