

# MERCEDES W210/S210 1995- CLK C208 1997-

## 12040103C

- D** Einbauanweisung  
Elektrischer Zubehörsatz
- GB** Installation Instructions  
Electrical Accessories Set
- F** Instructions de montage  
Jeu d'accessoires électriques
- I** Istruzioni di montaggio  
Kit di montaggio elettrico
- E** Instrucciones de montaje  
Juego de accesorios eléctrico
- NL** Inbouwhandleiding  
Elektrisch Toebehoorpakket



# INFO + ROUTING W210 / S210

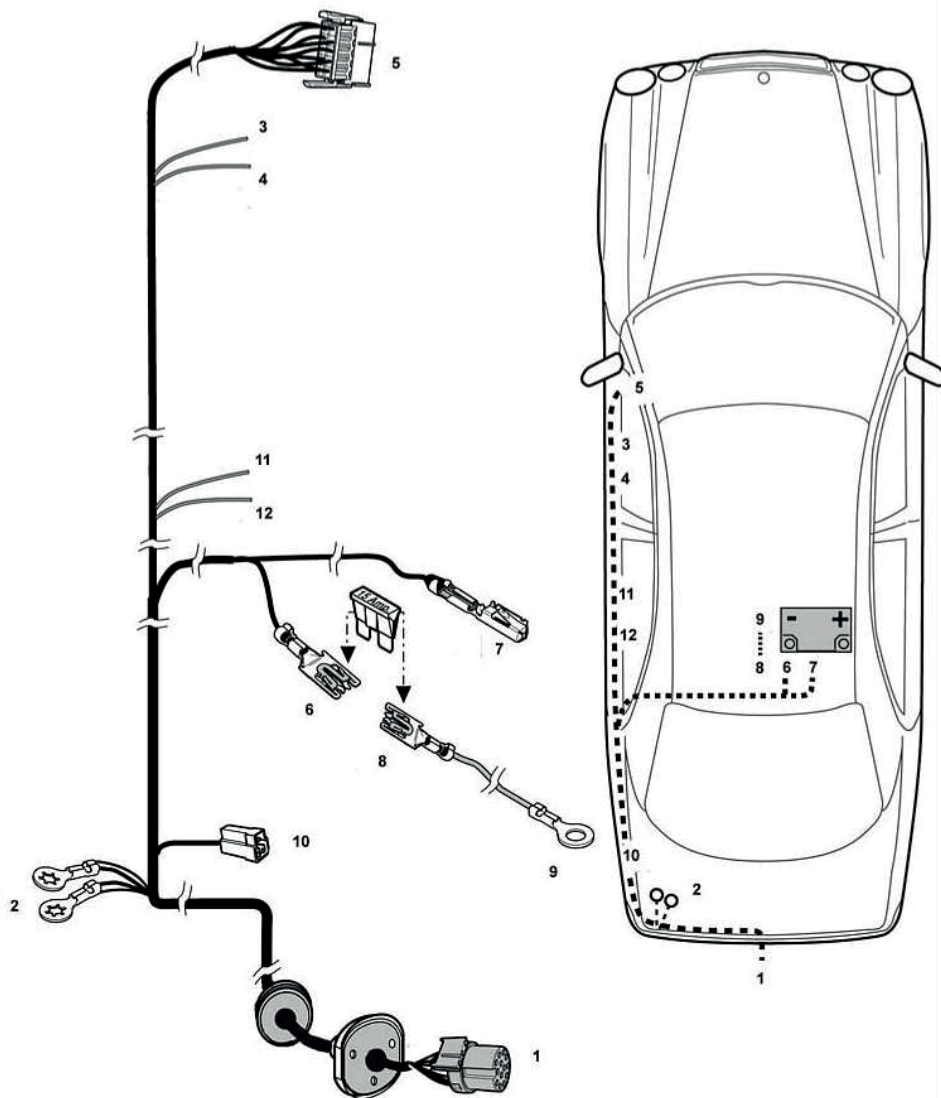

# INFO + ROUTING C208

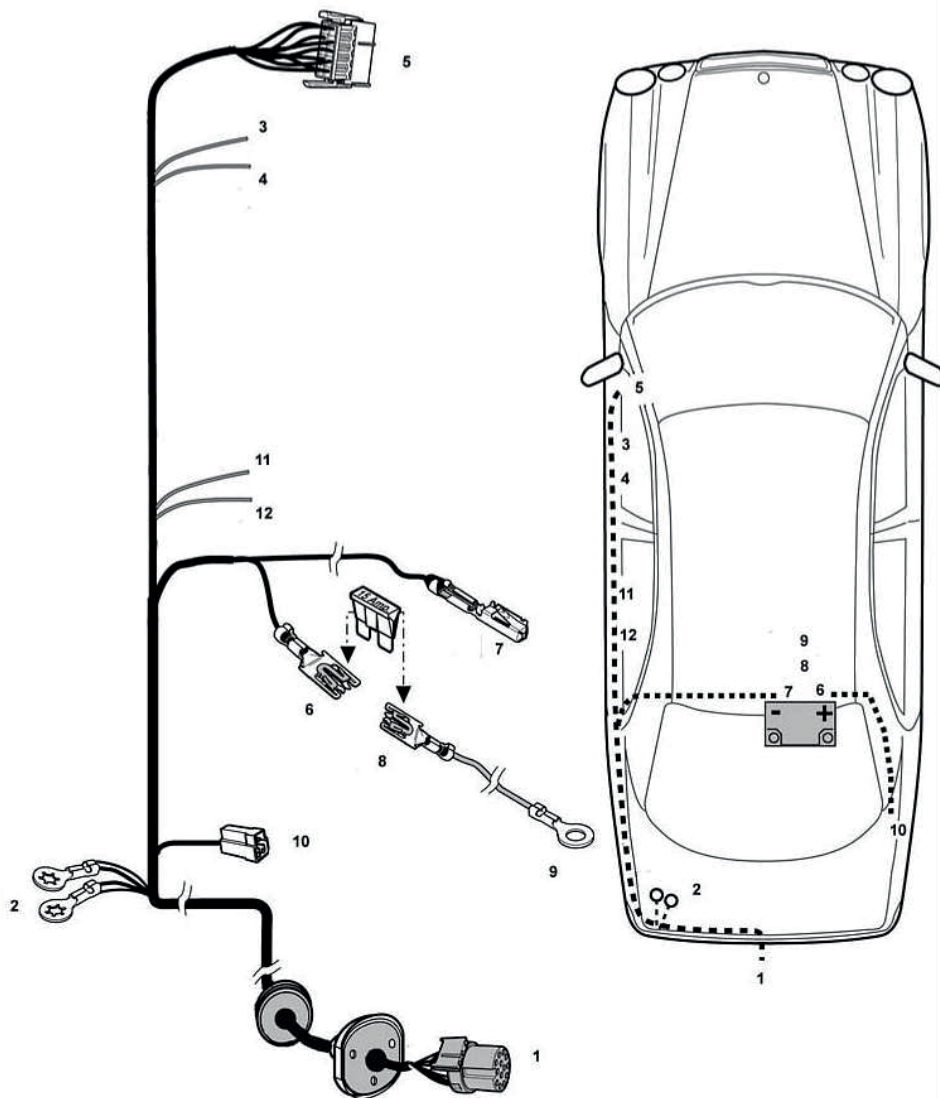

**W210**

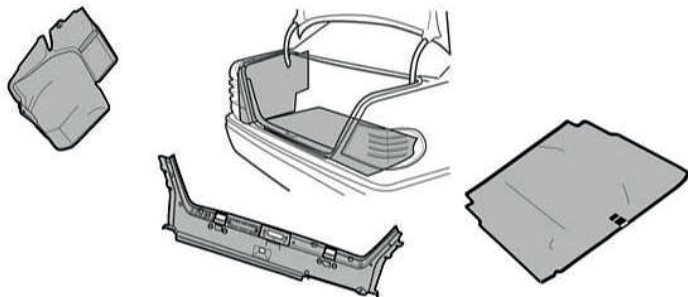

**S210**

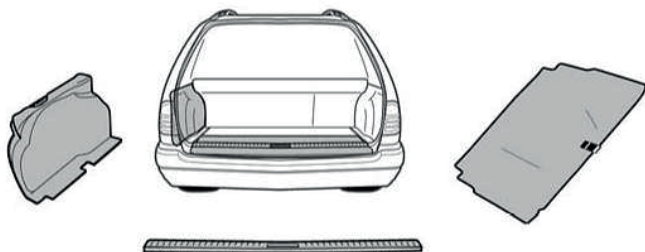

**W210+S210**

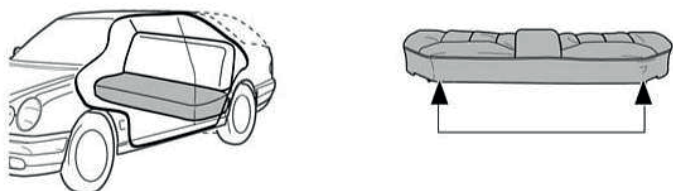

**C208**

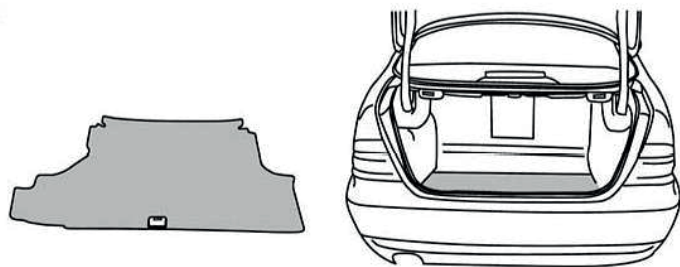

C208

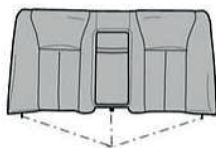
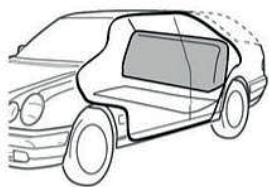
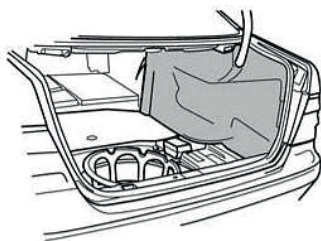
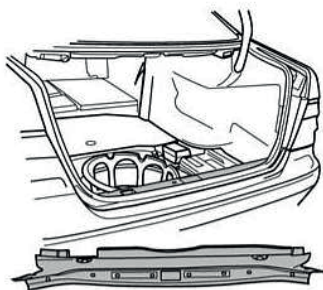

10 mm

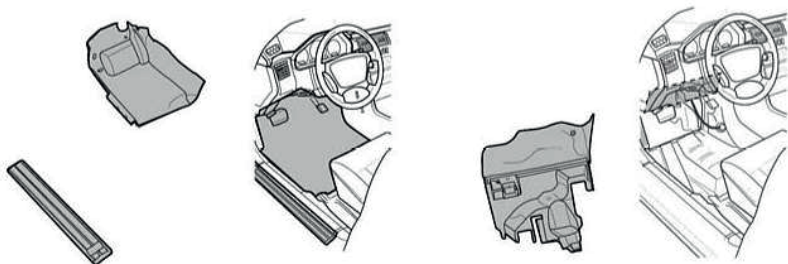
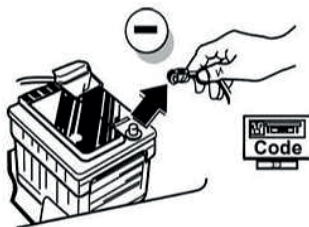

**C208**

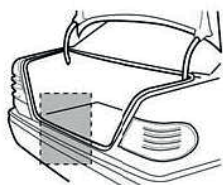
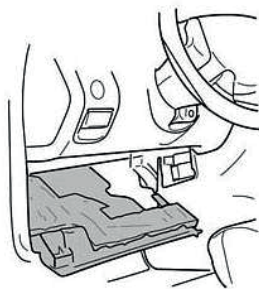
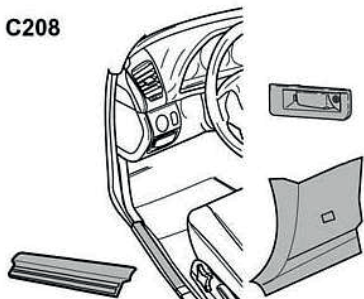

**W210**

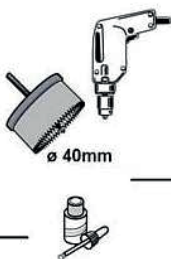
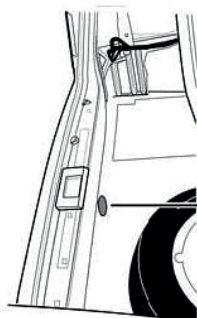

ø 40mm

**S210**

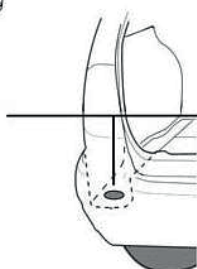

**C208**

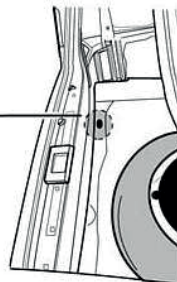

**W210+S210**

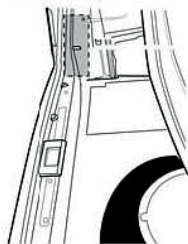

**C208**

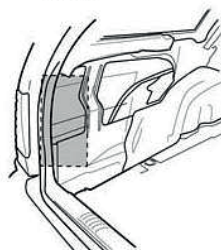
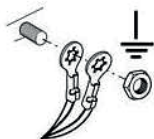

W210+S210

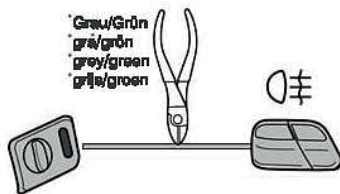
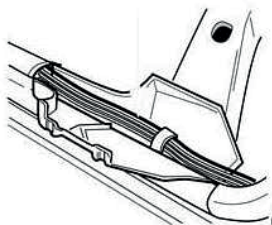
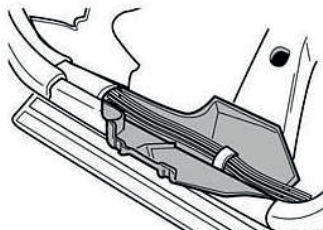
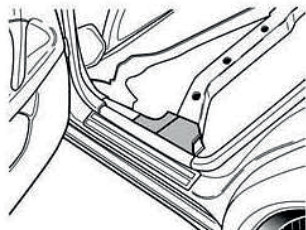

C208

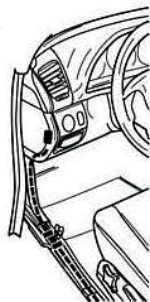

\*Grau/Grün  
\*grá/grön  
\*grey/green  
\*grijs/groen

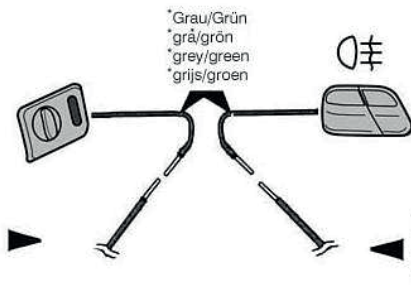
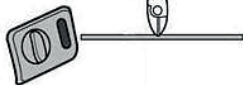

13p

W210+S210

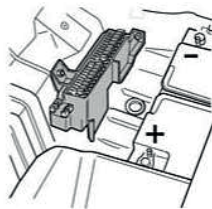
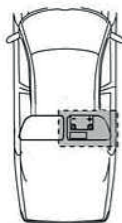

13p C208

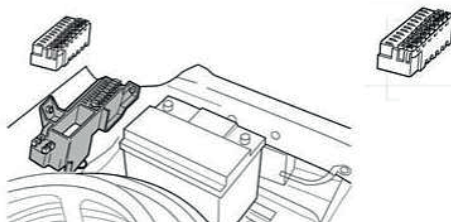
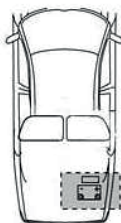

13p OPTIE 208

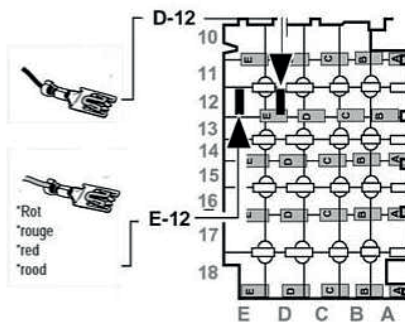
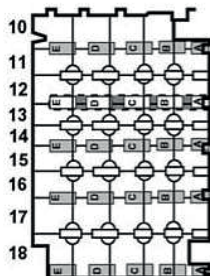
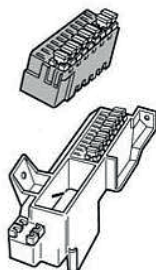
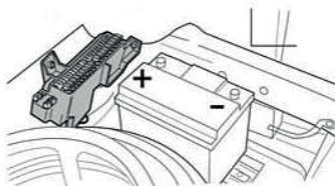
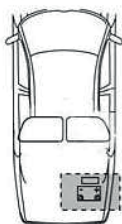



13p

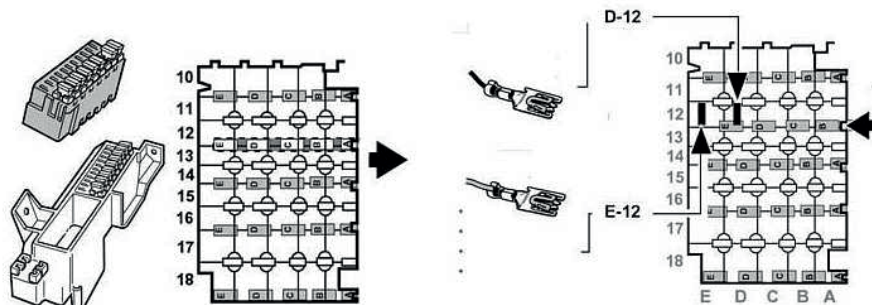

13p

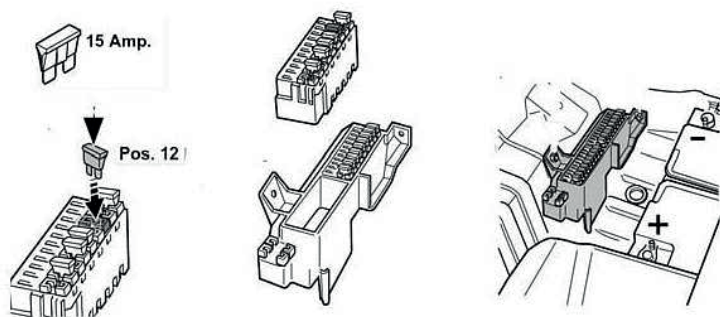

13p

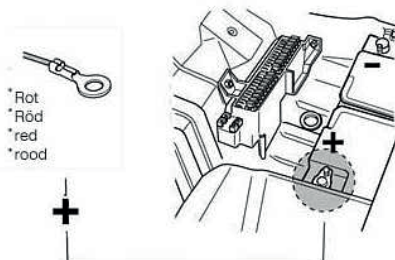

## W210 + S210

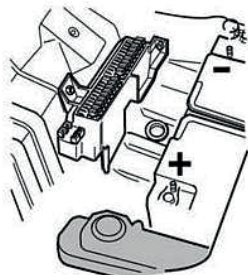

## C208



- X** kann 4-, 12- oder 18-polig sein  
Siehe in der Tabelle für die richtige Position
- X** kan vara 4-, 12- eller 18 pol  
se tabell för rätt position
- X** can be 4-, 12- or 18-pole  
See table for the right position
- X** kan 4-, 12- of 18-polig zijn  
Voor de juiste positie zie tabel

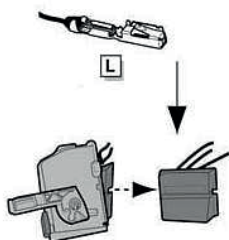
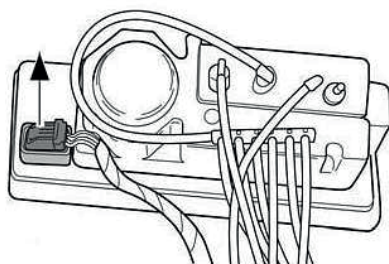

Poles	<b>X</b>	Position
4	→	2
12	→	2
18	→	15



⇄ L  
 \*Schwarz/Weiß  
 \*svart/vit  
 \*black/white  
 \*zwart/wit



R ⇄  
 \*Schwarz/Grün  
 \*svart/grön  
 \*black/green  
 \*zwart/groen

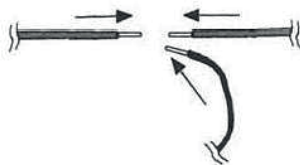

⇄ L

\*Schwarz/Weiß  
 \*svart/vit  
 \*black/white  
 \*zwart/wit

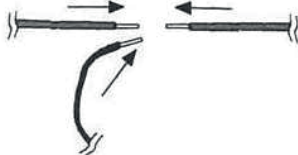

R ⇄

\*Schwarz/Grün  
 \*svart/grön  
 \*black/green  
 \*zwart/groen

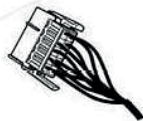
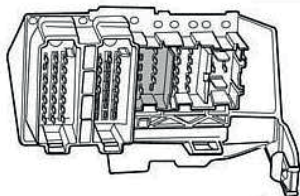
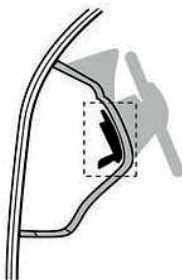

## Backverbare

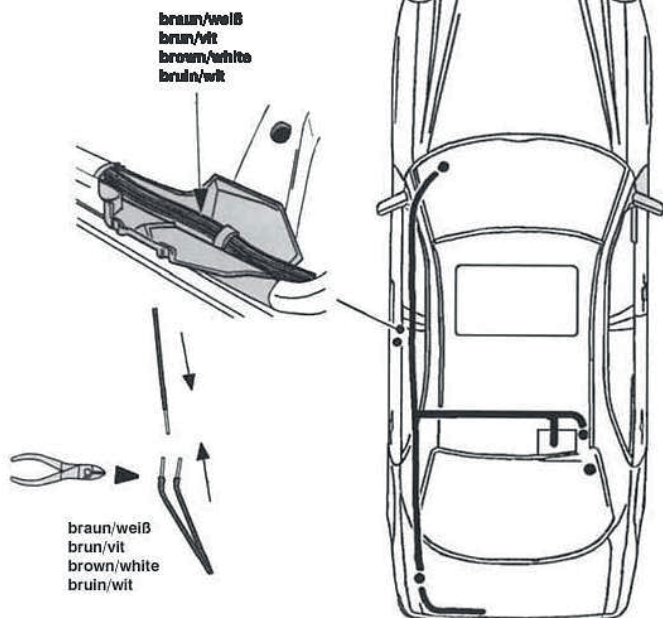

**Radio Code**



**FUNKTIONEN KONTROLLIEREN  
FUNKTIONSTEST  
CHECK FUNKTIONS  
CONTROLEER FUNCTIES**