



2002 -

RENAULT ESPACE

Cat. No. **R/034**

e20

e20*94/20*0763*00



2000Kg



80Kg

D = 11,29kN



$$D \text{ (kN)} = \frac{\text{MAX kg} \times \text{MAX kg}}{\text{MAX kg} + \text{MAX kg}} \times 0,00981$$



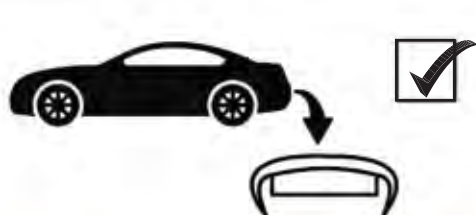

IMIOLA HAK-POL

96-111 KOWIESY, CHOJNATA 23A, POLAND

tel. +48 46 831 73 31, fax +48 831 74 29

e-mail: office@imiola.pl, www.imiola.pl

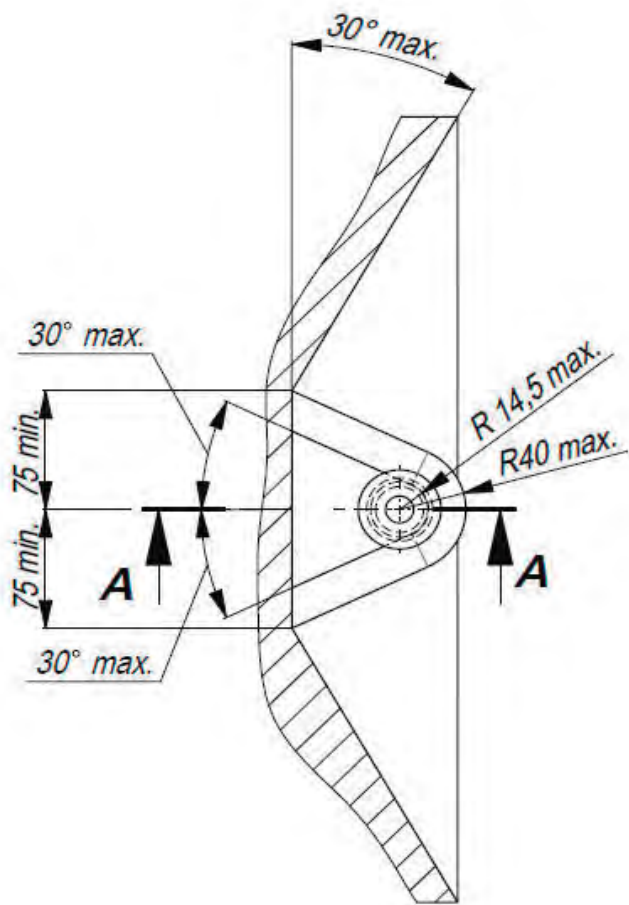

PRZEKRÓJ A-A

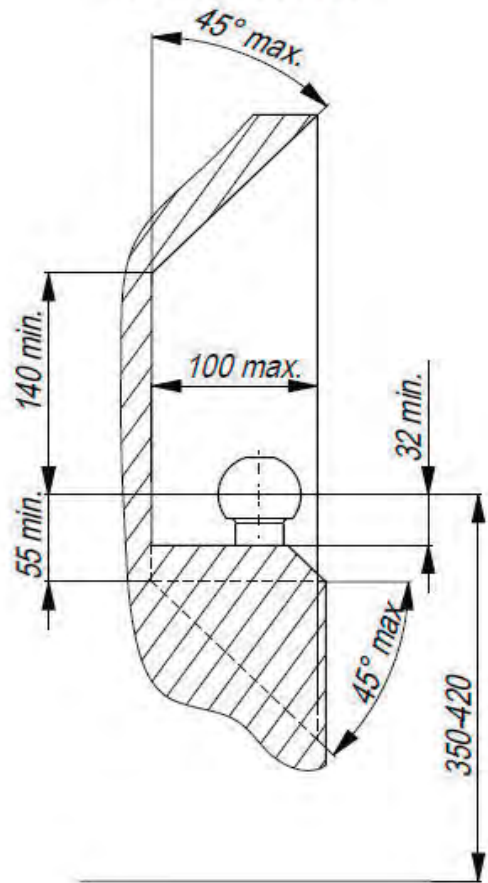

PL Należy zagwarantować przestrzeń swobodną według załącznika VII, rysunek 25a/b Regulaminu EKG ONZ 55.01 przy dopuszczalnym ciężarze całkowitym pojazdu.

GB The clearance specified in appendix VII, diagram 25a/b of Regulation No. 55.01 UN EU must be guaranteed at laden weight of the vehicle.

F L'espace libre doit être garanti conformément à l'annexe VII, illustration de la réglementation 55.01 CE pour un poids total en charge autorisé du véhicule.









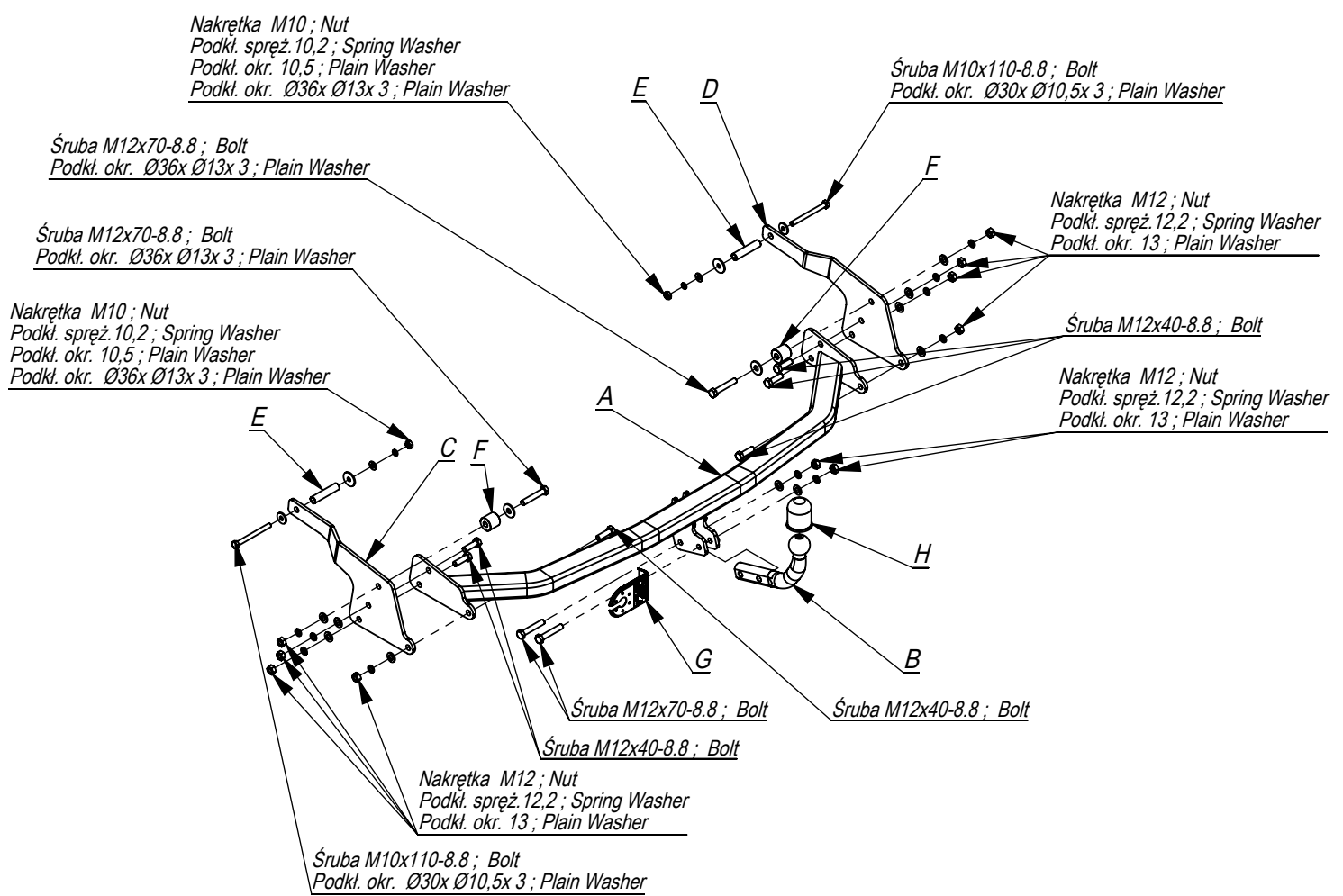

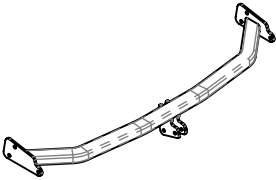
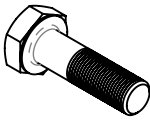
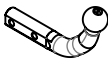
D Der Freiraum nach Anhang VII, Abbildung 25a/b der Vorschriften 55.01 EG ist zu gew 25a/b abzuweihen bei zulässigem Gesamtgewicht des Fahrzeuges

Moment skrczący dla śrub i nakrętek (8.8)
Torque settings for nuts and bolts (8.8)

M8	25Nm
M10	55Nm
M12	85Nm
M14	135Nm
M16	195Nm

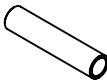



	A	x1		M12x70	4
				M12x40	6
				M10x110	2
	B	x1		M12	10
				M10	2
	C	x1		Ø36xØ13x3	4
				Ø30xØ10,5x3	2
	D	x1		13	10
				10,5	2
	E	x2		12,2	10
				10,2	2
	F	x2			
	G	x1			
	H	x1			

Nakrętka M10 ; Nut

Podkl. spręż. 10,2 ; Spring Washer

Podkl. okr. 10,5 ; Plain Washer

Podkl. okr. Ø36x Ø13x 3 ; Plain Washer

Śruba M12x70-8.8 ; Bolt

Podkl. okr. Ø36x Ø13x 3 ; Plain Washer

Śruba M12x70-8.8 ; Bolt

Podkl. okr. Ø36x Ø13x 3 ; Plain Washer

Nakrętka M10 ; Nut

Podkl. spręż. 10,2 ; Spring Washer

Podkl. okr. 10,5 ; Plain Washer

Podkl. okr. Ø36x Ø13x 3 ; Plain Washer

C

Pkt. 3

E

F

G

A

F

Pkt. 1

Pkt. 2

Pkt. 3

D

E

F

G

H

B

Nakrętka M12 ; Nut
Podkl. spręż. 12,2 ; Spring Washer
Podkl. okr. 13 ; Plain Washer

Śruba M12x40-8.8 ; Bolt

Nakrętka M12 ; Nut

Podkl. spręż. 12,2 ; Spring Washer

Podkl. okr. 13 ; Plain Washer

Śruba M12x40-8.8 ; Bolt

Śruba M12x70-8.8 ; Bolt

Nakrętka M12 ; Nut

Podkl. spręż. 12,2 ; Spring Washer

Podkl. okr. 13 ; Plain Washer

Śruba M10x110-8.8 ; Bolt

Podkl. okr. Ø30x Ø10,5x 3 ; Plain Washer

Śruba M10x110-8.8 ; Bolt
Podkl. okr. Ø30x Ø10,5x 3 ; Plain Washer



Nr katalogowy
R/034

Marka
Renault Espace

od 2002 ->

96-111 Kowiesy, Chojnata 23 A
tel. +48 46 831 73 31

- Odkręcić koło zapasowe.
- Odkręcić tylne koła oraz plastikowe kołpaki.
- W fabryczne otwory w podłużnicach od zewnętrznej strony włożyć tuleje dystansowe E.
- Przykręcić lekko elementy haka C i D śrubami M10x110 8.8 (pkt 3) oraz śrubami M12x70 8.8 (pkt 2) stosując tuleje dystansowe wg rys.
- Do elementów haka C i D przykręcić belkę haka A śrubami M12x40 8.8 (pkt 1).
- Przykręcić kulę i blachę gniazda elektrycznego śrubami M12x65 8.8 (pkt 4).
- Dokręcić wszystkie śruby z momentem wg tabeli.
- Przykręcić koła.
- Dokręcić plastikowe kołpaki (wyciąć wg schematu), przykręcić koło zapasowe.
- Podłączyć instalację elektryczną.

- Unscrew the spare wheel.
- Unscrew the rear wheels and plastic hubcaps.
- Insert distance sleeves E in the technological holes, in the metal clamps from the outside.
- Screw slightly the elements C and D with bolts M10x110 8.8 (point 3) and with bolts M12x70 8.8 (point 2) using distance sleeves according to the drawing.
- Screw the main bar A to the elements C and D with bolts M12x40 8.8 (point 1).
- Fix the ball and electric plate with bolts M12x65 8.8 (point 4).
- Tighten all the bolts according to the torque setting-see the table.
- Screw the wheels.
- Screw the plastic hubcaps (cut out according to the drawing), screw the spare wheel.
- Connect the electric wires.

- Desserrer la roue de secours.
- Dévisser les roues arrière et couvre-moyeux en plastique.
- Insérer les douilles d'écartement E dans les ouvertures de longerons face externe.
- Visser légèrement les éléments C et D de crochet par les boulons M10x110 8.8 (point 3) et boulons M12x70 8.8 (point 2) par les douilles d'écartement.
- Visser la traverse de crochet A aux éléments C et D de crochet par les boulons M12x40 8.8 (point 1).
- Visser le crochet d'attelage et socle de prise électrique par les boulons M12x65 8.8. (point 4).
- Serrer tous les boulons avec un couple de serrage selon tableau.
- Visser les roues.
- Serrer les couvre-moyeux en plastique (découper suivant schéma), visser le roue de secours.
- Raccorder le circuit électrique.

