

Kuga

06/08 → 01/13

D

Elektro-Einbausatz für Anhängerkupplung / 13-polig / 12 Volt / ISO 11446

Einbauanleitung

GB

Electric wiring kit for towbars / 13-pin / 12 Volt / ISO 11446

Fitting instructions

F

Faisceau électrique pour crochet d'attelage / 13 broches / 12 Volt / ISO 11446

Instructions de montage

I

Cablaggio elettrico per ganci di traino / 13 poli / 12 Volt / ISO 11446

Istruzione di montaggio

E

Kits eléctricos para enganches de remolques / 13 pins / 12 Volt / ISO 11446

Instrucciones de montaje

NL

Elektro-inbouwset voor aanhangerkoppeling / 13-polig / 12 Volt / ISO 11446

Montagehandleiding

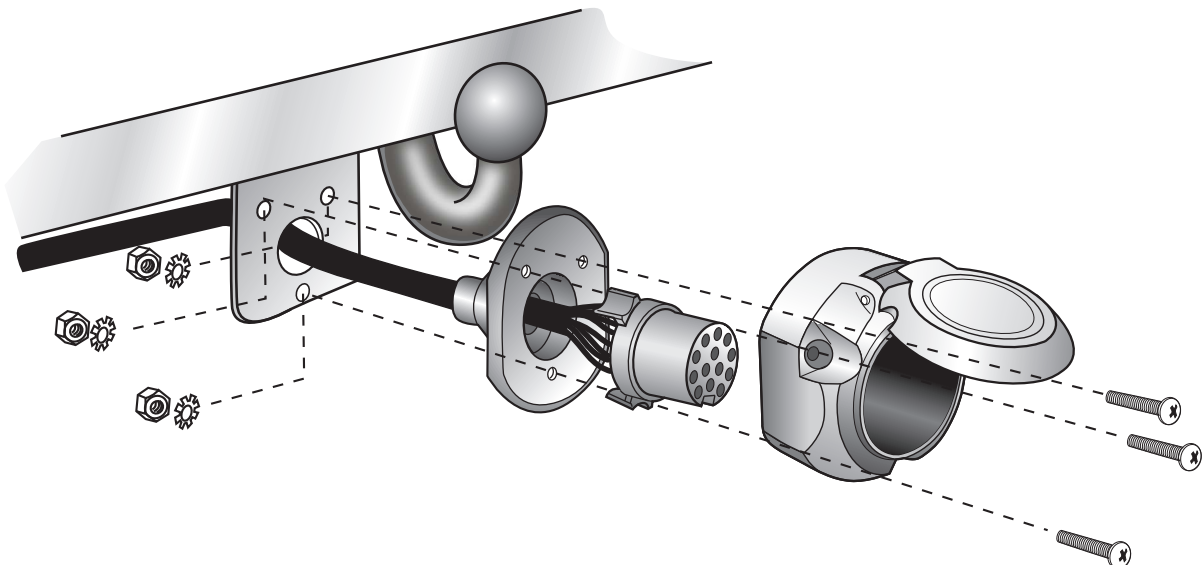

WICHTIG!

Der Einbau dieses Elektrosatzes muß von einer Fachwerkstatt oder einer entsprechend qualifizierten Person durchgeführt werden. Vor Beginn aller Montagearbeiten unbedingt die Einbauanleitung komplett durchlesen. Nach Einbau des Elektrosatzes ist die Einbauanleitung den Serviceunterlagen des Fahrzeuges beizulegen!

Bei unsachgemäßer Anwendung oder Veränderung des Elektrosatzes bzw. der darin befindlichen Bauteile erlischt jeder Anspruch auf Gewährleistung. Beim Fahren ohne Anhänger oder Ladungsträger müssen ggf. verwendete Adapter immer aus der Steckdose entfernt werden. Änderungen bezüglich Konstruktion, Ausstattung, Farbe sowie Irrtum vorbehalten. Alle Angaben und Abbildungen unverbindlich.

Bei Anhängern ohne Nebelschlussleuchte sollte diese nachgerüstet werden.

Für technische bzw. elektronische Änderungen, welche nach erstmaliger Inbetriebnahme des Elektrosatzes vom Fahrzeughersteller durchgeführt werden und beispielsweise zu Fehlfunktionen der Anhängersteckdose oder deren Peripherie führen, übernehmen wir keinerlei Gewährleistung!

Das Anhängermodul ist nicht diagnosefähig! Sollten herstellerseitige Diagnoseprozesse bzw. softwaregestützte Prüfmechanismen Fehlerprotokolle generieren, welche direkt oder indirekt mit Anhängerbetrieb in Zusammenhang stehen, ist das Anhängermodul vom Leitungssatz für die Anhängersteckdose zu trennen und ein nochmaliger Diagnosevorgang zu starten!

IMPORTANT!

Installation of the towing electrics kit must be undertaken by a specialist workshop or an appropriately qualified person. Before starting work, you must read the installation instructions through completely. After installing the towing electrics kit, the installation instructions should be kept with the vehicle service documentation.

All claims under the guarantee will lapse in case of improper use or modification of the towing electrics kit or any of its component parts. When driving without a trailer or load carrier, any adapter installed must be removed from the electrical socket. We reserve the right to alter the design, content or colour. We accept no liability for any errors in these instructions. All details and illustrations are non-binding.

In case of missing a rear fog lamp on the trailer, it should be retrofitted.

We accept no responsibility and give no guarantee for technical and electrical modifications made after the initial operation of the towing electrics kit by the vehicle manufacturer and which may lead, for example to malfunction of the trailer socket or its peripheries.

The trailer module is not diagnostics-capable. If the manufacturer's diagnostics processes or software-supported test mechanisms generate error reports directly or indirectly linked with trailer operation, the trailer module must be disconnected from the leads to the trailer socket and a new diagnostic process initiated.

IMPORTANT!

Le montage du kit de connexion électrique doit être effectué par un atelier spécialisé ou par une personne qualifiée en la matière. Avant le début des travaux, lire impérativement les instructions de montage dans leur intégralité. Après le montage du kit de connexion électrique, joindre les instructions de montage aux documents du véhicule.

Un usage inapproprié ou des modifications du kit de connexion électrique, ou des pièces qui le composent, entraînent l'expiration de tout droit à la garantie. Lors d'une conduite sans remorque ou porteur de charge, les adaptateurs utilisés doivent, le cas échéant, toujours être enlevés de la prise de courant. Sous réserve de modifications de constructions, équipement, couleurs ou erreur. Données et illustrations sous toute réserve.

Pour les remorques qui ne sont pas équipées avec feux anti-brouillard arrière, il devrait être installé.

Nous n'assumons aucune responsabilité ni garantie pour les modifications techniques et électroniques ayant été effectuées après la première mise en service du kit de connexion électrique par le constructeur automobile et ayant mené par exemple à des mauvais fonctionnements de la prise de remorque ou de sa périphérie.

Le module remorque ne contient pas de fonction diagnostic! Au cas où des processus de diagnostic définis par le fabricant ou des mécanismes de contrôle assistés par ordinateur devaient générer des messages d'erreur directement ou indirectement en rapport avec le fonctionnement de la remorque, il est impératif pour la prise de remorque de détacher le module remorque du groupe électrique et d'initier une nouvelle procédure de diagnostic.

IMPORTANTE!

L'installazione del kit elettrico deve essere effettuata da un'officina o da personale specializzato. Prima di iniziare tutti i lavori di montaggio, leggere da cima a fondo le istruzioni. Dopo aver installato il kit elettrico si prega di allegare le istruzioni di montaggio ai documenti di manutenzione del veicolo!

In caso di uso improprio o di modifiche del kit elettrico e delle componenti del medesimo, ogni diritto di garanzia decade. Durante la guida senza rimorchio o portacarichi, togliere sempre gli adattatori dalla presa di corrente. Con riserva di modifiche relative a costruzione, equipaggiamento, colore e salvo errori. Tutte le indicazioni e illustrazioni non sono vincolanti.

In caso di rimorchi non corredati di luce retronebbia, questa dovrebbe essere installata.

Per le modifiche tecniche ed elettroniche eseguite dopo la prima messa in funzione del kit elettrico da parte del costruttore del veicolo, e che portano, per esempio, a un malfunzionamento della presa del rimorchio o della sua periferia, non ci assumiamo alcuna responsabilità!

Il modulo del rimorchio non è idoneo alla diagnosi! Nel caso in cui processi diagnostici o apparecchiature di prova controllate da software dovessero generare dei protocolli d'errore in rapporto diretto o indiretto con l'uso del rimorchio, si deve staccare il modulo del rimorchio dal conduttore per la presa del rimorchio, e avviare nuovamente la diagnosi!

¡IMPORTANTE!

El montaje del equipo eléctrico deberá llevarse a cabo en un taller especializado o por parte de una persona correspondientemente calificada. Antes de comenzar cualquier trabajo de montaje es imprescindible haberse leído las instrucciones de montaje por completo. ¡Después de haber realizado el montaje del equipo eléctrico deben adjuntarse las instrucciones de montaje a los documentos de servicio del vehículo!

En caso de una utilización inadecuada o de una modificación del equipo eléctrico o de los componentes incluidos respectivamente se extinguirá cualquier derecho de garantía. En caso de conducir sin remolque o sin portacargas deberán sacarse siempre del enchufe los adaptadores que hayan podido ser utilizados. Queda reservado el derecho de modificaciones con respecto a la construcción, el equipamiento, el color y de errores. Todas las informaciones y reproducciones se entienden sin compromiso.

Al tratarse de remolques sin luz antiniebla trasera, esta debería ser reequipada.

¡No asumiremos ninguna clase de garantía por modificaciones técnicas o electrónicas respectivamente que se lleven a cabo después de la primera puesta en funcionamiento del equipo eléctrico por parte del fabricante del vehículo y que puedan provocar por ejemplo un mal funcionamiento del enchufe del remolque o de los correspondientes componentes periféricos!

¡El módulo para el remolque no puede someterse a un diagnóstico! En caso de que los procesos de diagnóstico por parte del fabricante o que los mecanismos de comprobación asistidos por software generen informes de errores que estén directa o indirectamente relacionados con el servicio con remolque, deberá separarse el módulo para el remolque de los cables de conexión para el enchufe del remolque e iniciarse un nuevo proceso de diagnóstico!

BELANGRIJK!

De inbouw van deze elektroset moet door een vakwerkplaats of door een overeenkomstig gekwalificeerde persoon gebeuren. Vóór aanvang van alle montagewerkzaamheden absoluut de montagehandleiding volledig doorlezen. Na inbouw van de elektroset dient de montagehandleiding bij de servicedocumenten van het voertuig te worden geplagd!

Bij ondeskundige toepassing of wijziging van de elektroset c.q. van de daarin zittende componenten vervalt elke aanspraak op fabrieksgarantie. Tijdens het rijden zonder aanhanger of ladingdrager moeten evtl. gebruikte adapters altijd uit de stekkerdoos worden verwijderd. Wijzigingen met betrekking tot constructie, uitvoering, kleur alsmede vergissing voorbehouden. Alle opgaven en afbeeldingen niet-bindend.

Bij aanhangers zonder mistachterlicht dient dit achteraf te worden gemonteerd.

Wij verlenen generlei fabrieksgarantie voor technische c.q. elektronische wijzigingen die na de eerste inbedrijfstelling van de elektroset door de voertuigfabrikant worden uitgevoerd en bijvoorbeeld leiden tot foutieve functies van de stekkerdoos van de aanhanger of diens periferie!

De aanhangermodule kan niet worden diagnosticeerd! Mochten diagnoseprocessen van de kant van de fabrikant c.q. op software steunende testmechanismen foutprotocollen genereren die direct of indirect in verband staan met het gebruik van de aanhanger, dan dient de aanhangermodule te worden losgekoppeld van de kabelset voor de aanhangerstekkerdoos en dient het diagnoseproces nogmaals te worden gestart!

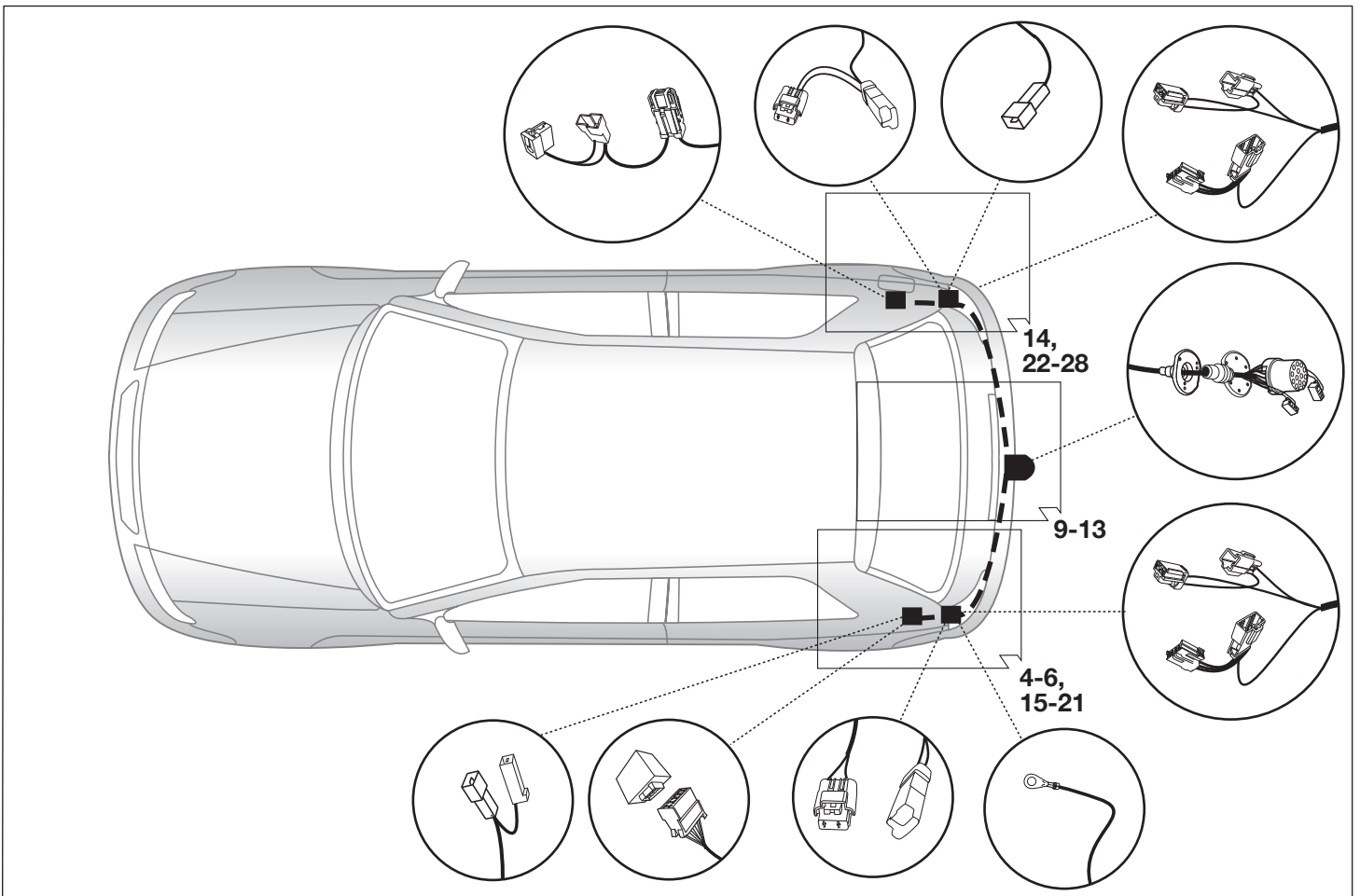
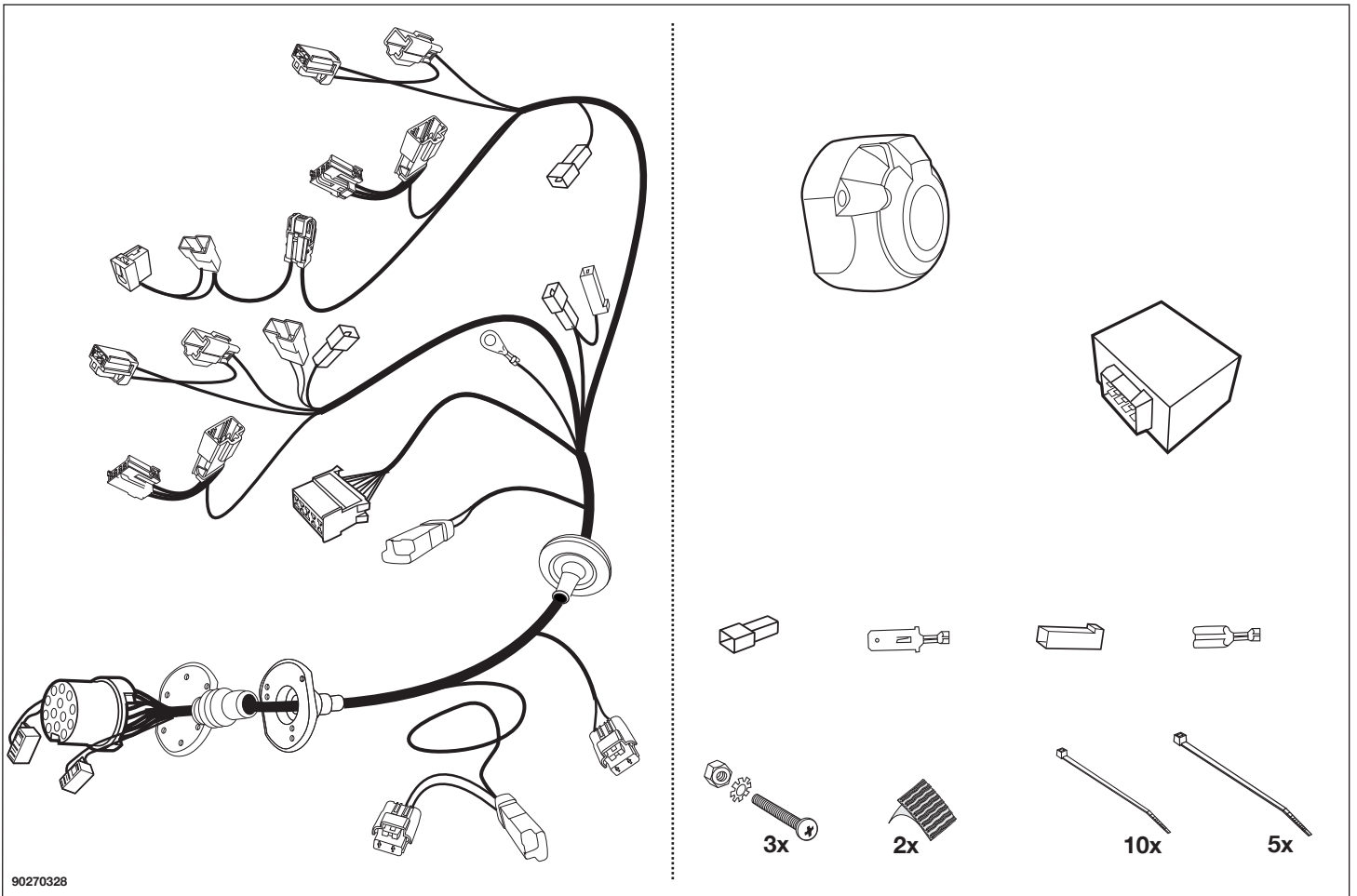

ACHTUNG!	ATTENTION!	ATTENTION!	ATTENZIONE!	¡ATENCIÓN!	ATTENTIE!
(D)	(GB)	(F)	(I)	(E)	(NL)
Die Kühlerleistung des Fahrzeuges muß bei Nachrüstung einer Anhängerkupplung möglicherweise erhöht werden! Bitte unbedingt Herstellerangaben beachten!!	The vehicle's cooling capacity may have to be increased when retrofitting a trailer coupling! You must observe the manufacturer's instructions!!	Il peut s'avérer nécessaire d'augmenter la puissance du radiateur du véhicule lorsque celui est équipé ultérieurement d'un attelage remorque! Respecter impérativement les instructions du constructeur!!	La capacità di raffreddamento del veicolo, quando si applica un gancio di traino, si deve possibilmente aumentare! Si prega di osservare tassativamente le indicazioni del produttore!!	¡Es posible que haya que aumentar la capacidad del radiador en caso de reequipar un acoplamiento de remolque! ¡Rogamos tener en cuenta las instrucciones de fabricante sin falta!	Het koelvermogen van het voertuig moet mogelijk worden verhoogd als achteraf een aanhangerkoppeling wordt aangebracht! Absoluut de fabrieksopgaven in acht nemen a.u.b.!!



ACHTUNG!	ATTENTION!	ATTENTION!	ATTENZIONE!	¡ATENCIÓN!	ATTENTIE!
(D)	(GB)	(F)	(I)	(E)	(NL)
Um Störungen und Schäden am Bordnetz zu vermeiden, muss die Massepolklemme unbedingt vor Beginn aller Arbeiten von der Fahrzeugbatterie getrennt werden! Insbesondere bei Arbeiten und Anschlüssen am CAN-Datenbus kann bei nicht abgeklemmter Batterie sowohl das Anhängermodule als auch das fahrzeugseitige Bordnetzsteuergerät beschädigt werden! Bitte Herstellervorschriften beim Ab- und Anklemmen der Fahrzeugbatterie beachten!	In order to avoid mal-functions and damage to the vehicle's electrical system the earth terminal must be disconnected from the vehicle's battery before starting work! Both the trailer module and the vehicle's control unit for the electrical system can be damaged during work on the CAN data bus connections if the battery is not disconnected! Please pay attention to the manufacturer's instructions when disconnecting and reconnecting the vehicle's battery!	Afin d'éviter tout dysfonctionnement ou endommagement du circuit de bord, il est indispensable de débrancher la pince de masse de la batterie du véhicule avant le début de toute opération! En particulier s'il s'agit de travaux et de branchements effectués sur le bus de données CAN, si la batterie n'est pas débranchée, le module remorque aussi bien que le dispositif de commande de circuit de bord du véhicule risquent d'être endommagés! Veuillez respecter les directives du fabricant lors du branchement et du débranchement de la batterie du véhicule!	Per evitare disturbi e danni alla rete di distribuzione elettrica, l'espansione polare a massa deve essere assolutamente scollegata dalla batteria del veicolo prima dell'inizio dei lavori! In particolare durante i lavori e gli allacciamenti al bus di dati CAN, se la batteria non è scollegata si possono danneggiare sia la centralina rimorchio, sia la centralina della rete di distribuzione elettrica del veicolo! Attenersi alle indicazioni del costruttore per scollegare e ricollegare la batteria del veicolo!	¡Para evitar fallos y defectos en el sistema eléctrico de a bordo es imprescindible separar al terminal de puesta a tierra de la batería del vehículo antes de reali-zar cualquier trabajo! ¡Particularmente al realizar trabajos y conexiones al bus de datos CAN puede estropearse tanto el módulo para remolques como el regulador del sistema eléctrico de a bordo del vehículo si no se ha desconectado la batería! ¡Rogamos observar las instrucciones del fabricante al conectar y desconectar la batería del vehículo!	Om storingen en schade aan de elektrische bedrading te vermijden moet de massapoolklem absoluut vóór aanvang van alle werkzaamheden worden losgekoppeld van de voertuigaccu! Vooral bij werkzaamheden aan en aansluitingen op de CAN-databus kan zowel de aanhangermodule als de voertuigzijdige regelenheid voor de elektrische installatie beschadigd worden, als de accu niet ontkoppeld is! Fabrieksvorschriften bij het vasten loskoppelen van de voertuigaccu in acht nemen a.u.b.!

1

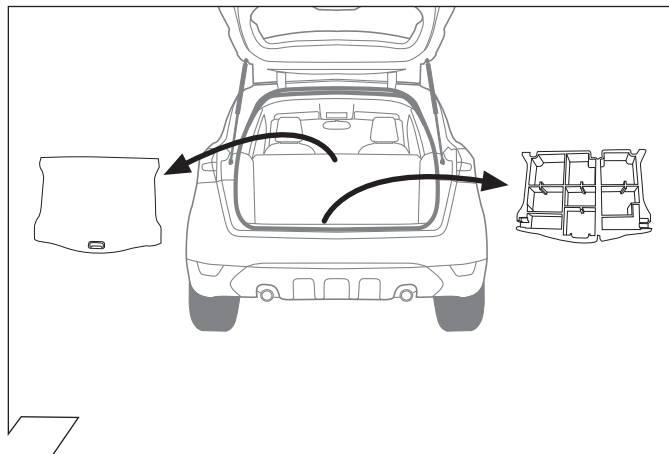

2

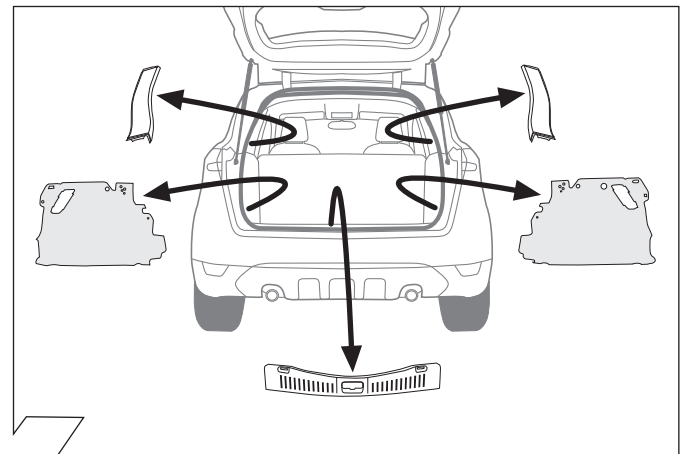

3

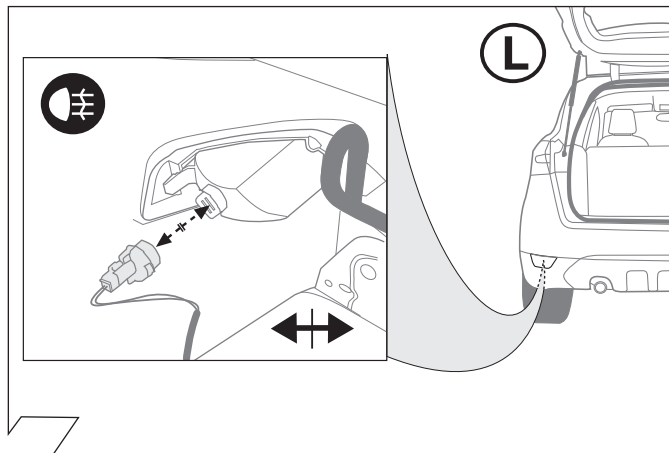

4

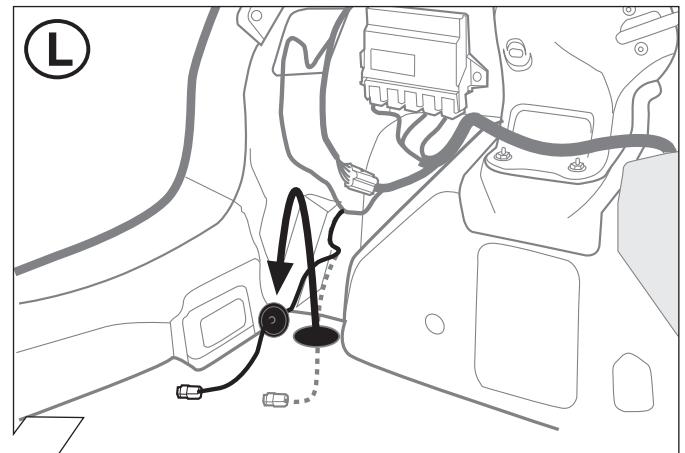

5

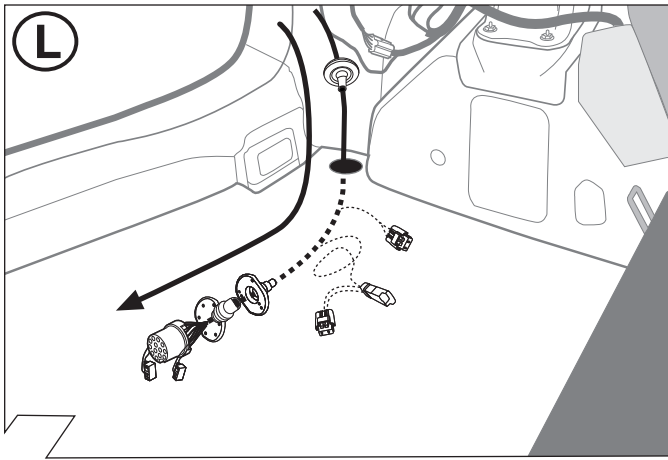

6

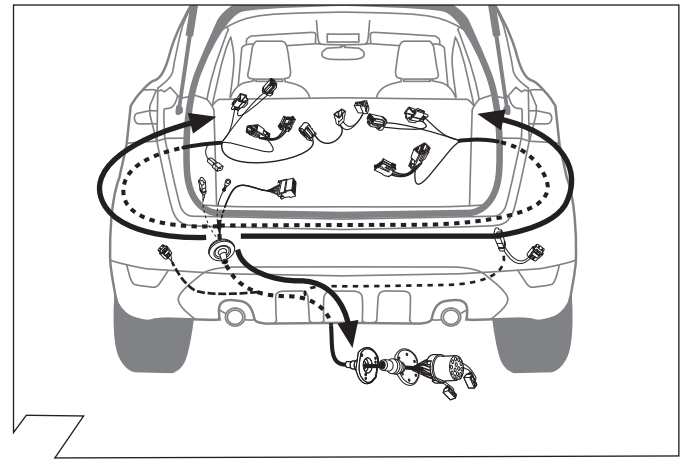

7

	(GB)	(D)	(E)	(F)	(I)	(P)	(NL)	(DK)	(N)	(S)	(FIN)	(CZ)	(H)	(PL)
BK	Black	Schwarz	Negro	Noir	Nero	Preto	Zwart	Sort	Svart	Svart	Musta	Černá	Fekete	Czarny
RD	Red	Rot	Rojo	Rouge	Rosso	Vermelho	Rood	Rød	Rød	Röd	Punainen	Červená	Piros	Czerwony
GN	Green	Grün	Verde	Vert	Verde	Verde	Groen	Grøn	Grønt	Grön	Vihreä	Zelená	Zöld	Zielony
OR	Orange	Orange	Naranja	Orange	Arancione	Laranja	Oranje	Orange	Orange	Orange	Oranssi	Oranzová	Narancs	Pomarańczowy
VT	Violet	Violett	Violeta	Violet	Viola	Violeta	Violet	Violet	Fiolett	Violett	Violetti	Fialová	Ibolya	Fioletowy
PK	Pink	Pink	Pink	Rose	Rosa	Cor-de-Rosa	Paars	Pink	Pink	Rosa	Pinkki	Růžová	Rózsaszín	Różowy
BL	Blue	Blau	Azul	Bleu	Blu	Azul	Blauw	Blå	Blått	Blå	Sininen	Modrá	Kék	Niebieski
YL	Yellow	Gelb	Amarillo	Jaune	Giallo	Amarelo	Geel	Gul	Gult	Gul	Keltainen	Zlutá	Sárga	Żółty
WT	White	Weiss	Blanco	Blanc	Bianco	Branco	Wit	Hvid	Hvitt	Vit	Valkoinen	Bílá	Fehér	Biały
BR	Brown	Braun	Marrón	Brun	Marrone	Marrom	Bruin	Brun	Brunt	Brun	Ruskea	Hnědá	Barna	Brazowy
GY	Grey	Grau	Gris	Gris	Grigio	Cinzeno	Grijs	Grå	Grått	Grå	Harmaa	Sedá	Szürke	Szary

90500580

8

ISO 11446	Belegung der Steckdose / Maximale Ausgangsleistung Socket configuration / Maximum power output Correspondance des contacts de la prise / Puissance de sortie maximale Abbinamento della presa / Uscita di alimentazione massima Indeling van de stekkerdoos / maximaal uitgangsvermogen			
	1/L	BK/WT	21W	
	2	WT	42W	
	3/31	BR		
	4/R	BK/GN	21W	
	5/58-R	GY/RD	52W	
	6/54	BK/RD	63W	
	7/58-L	GY/BK	52W	
	8	BL/RD	42W	
	9	RD	240W	
	10	YL	180W	
	11	YL/BR		
	12			
	13	RD/BR		

9

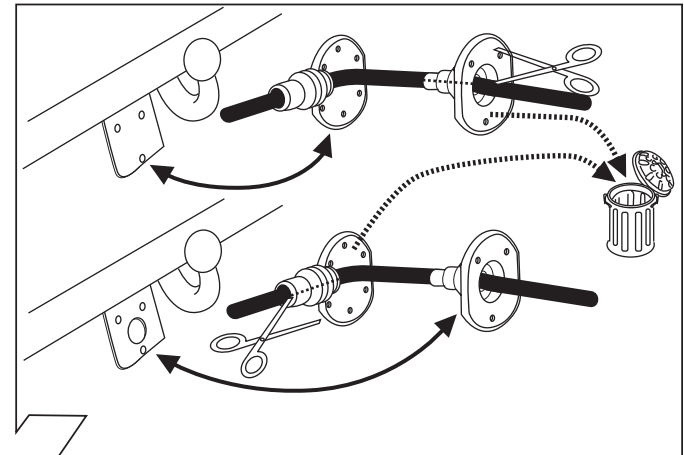

10

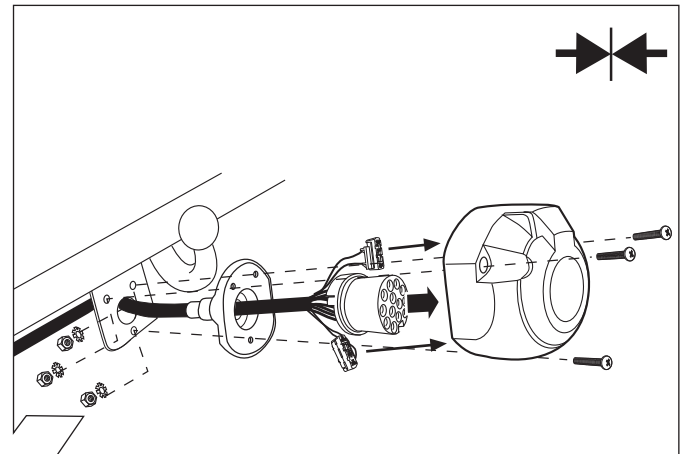

11

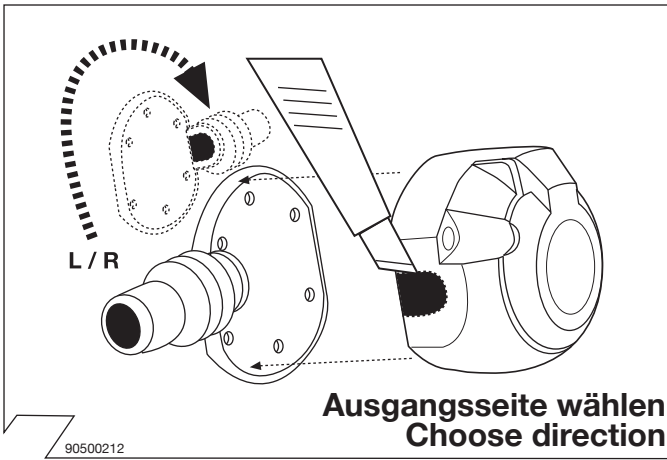

12

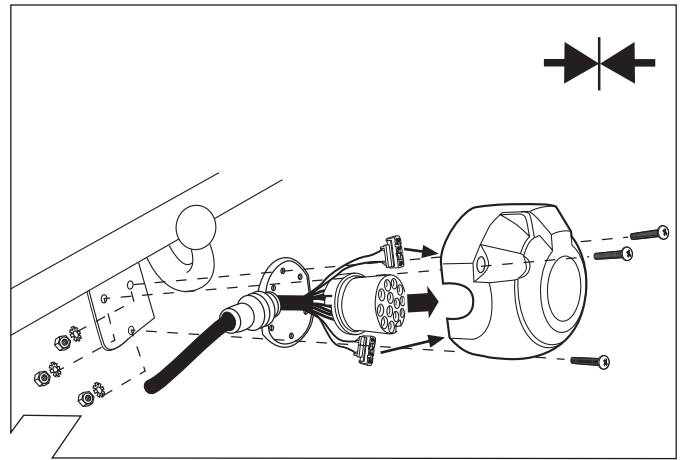

13

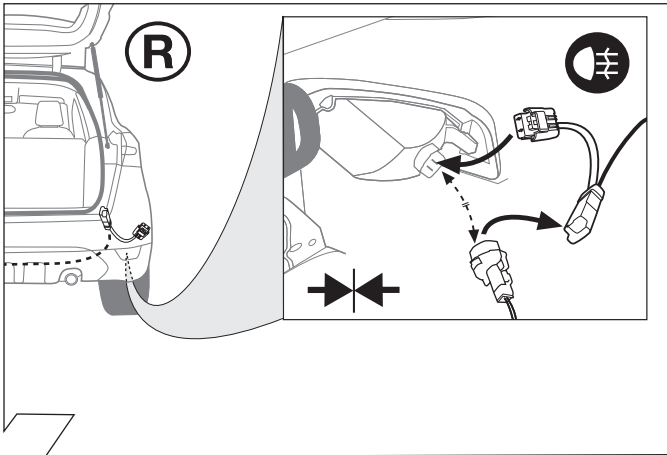

14

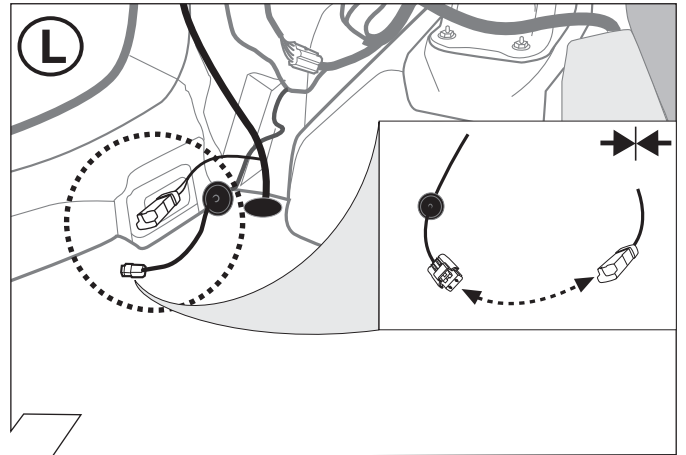

15

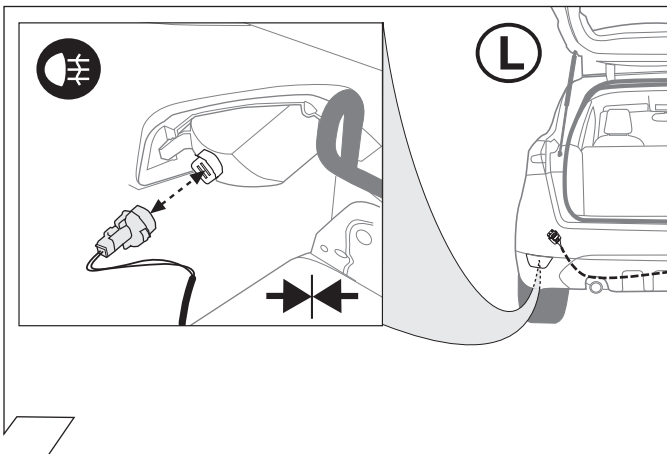

16

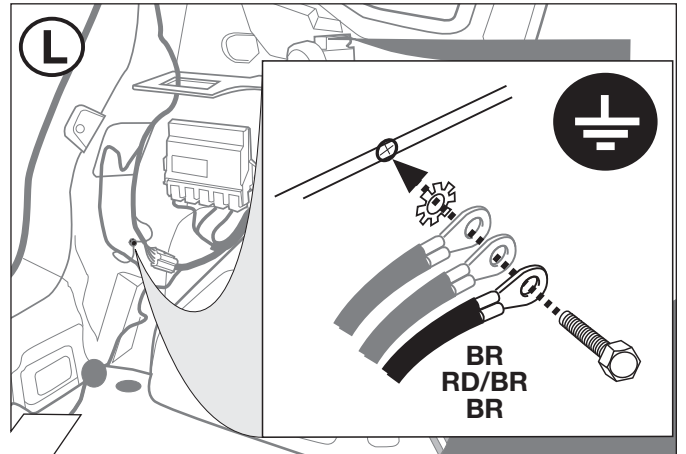

17

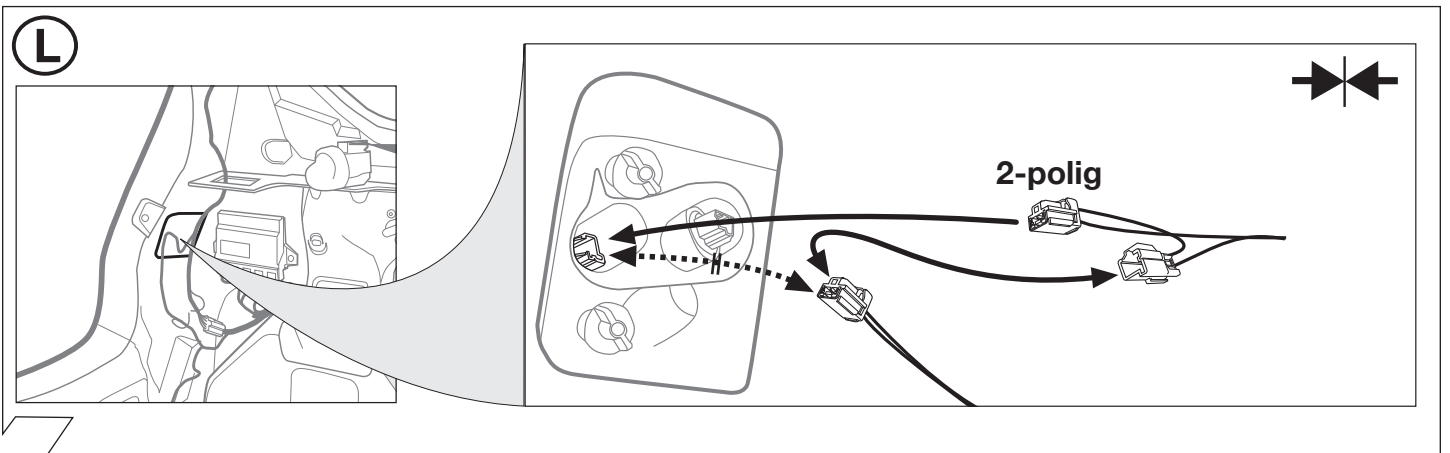

18

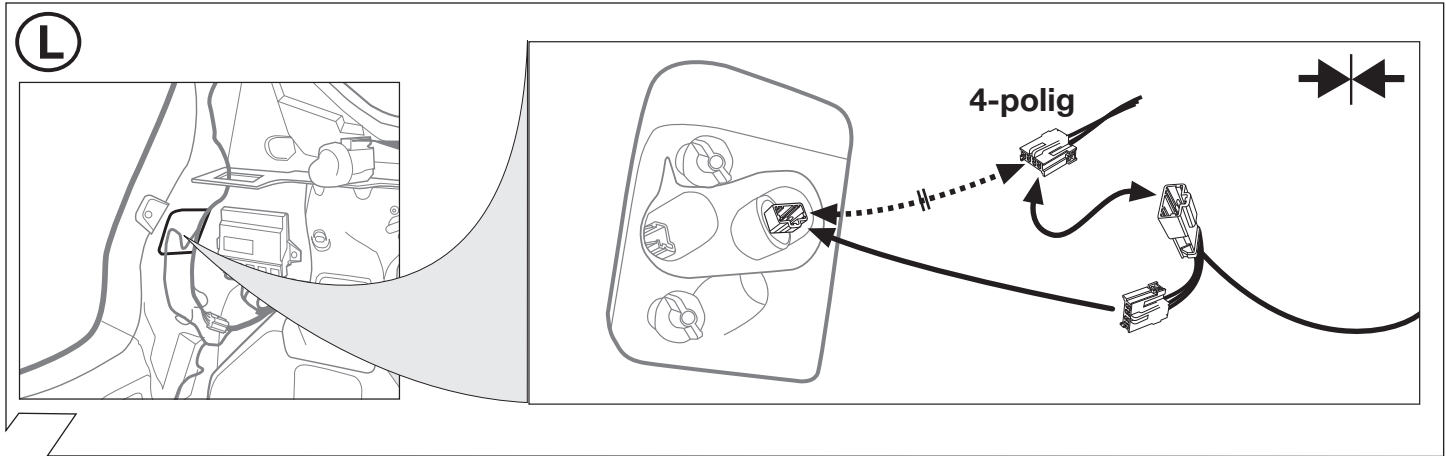

19

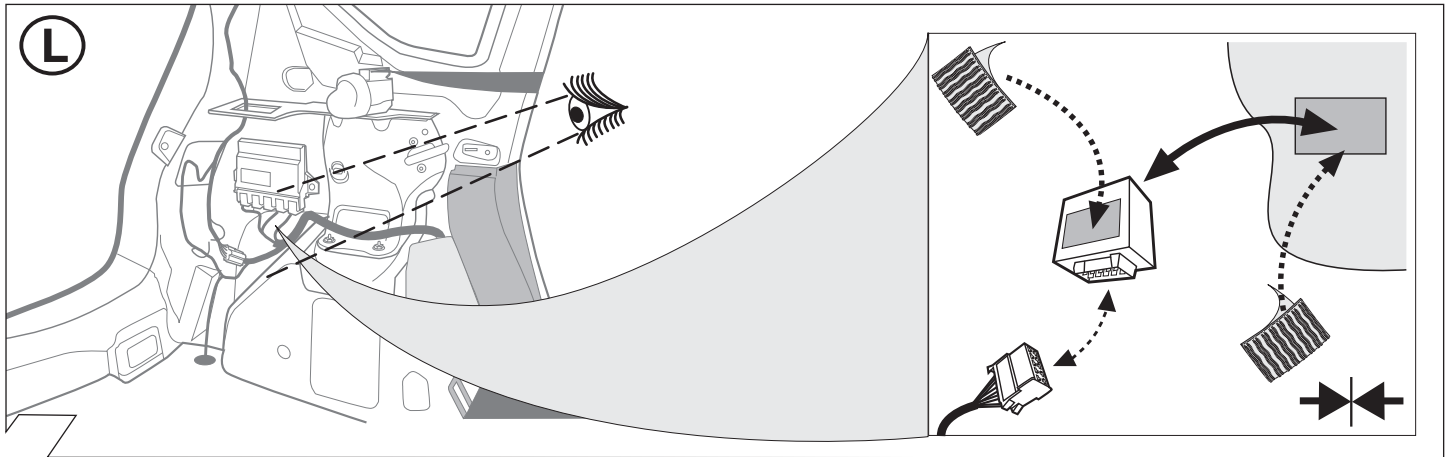

20

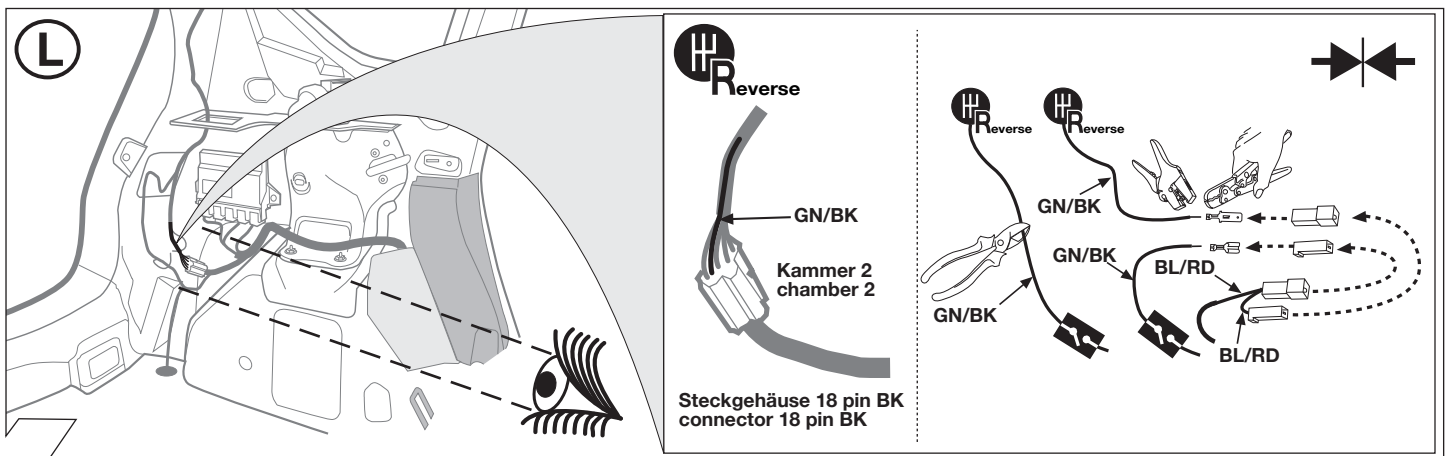

21

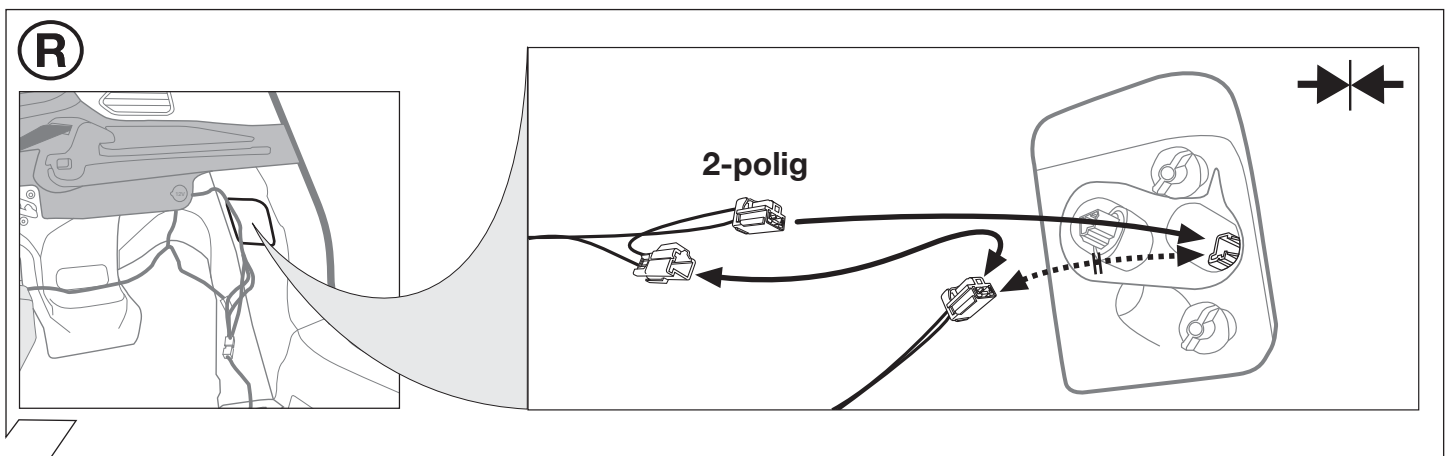

22

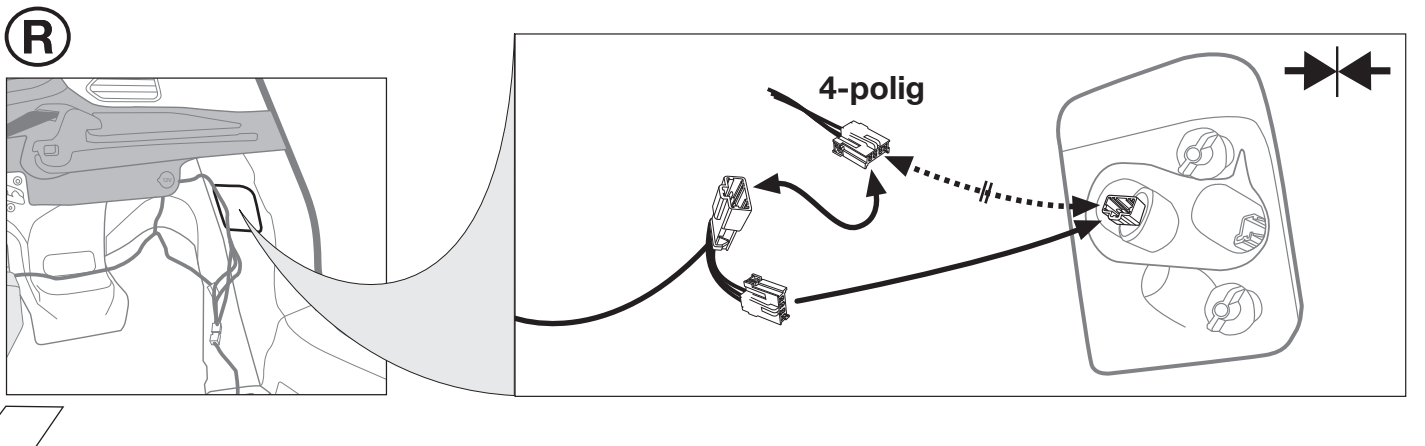

23

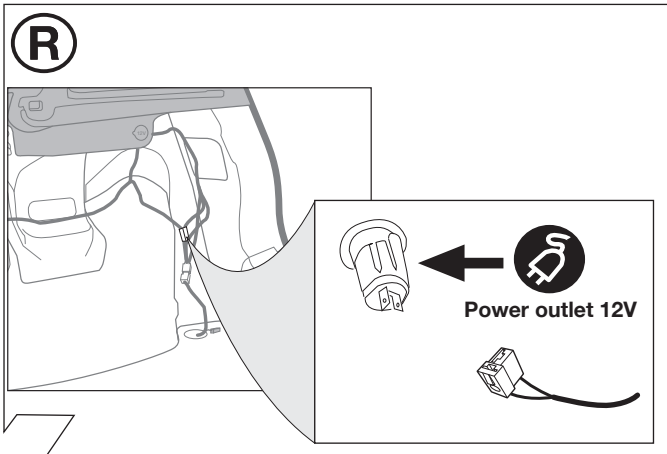

24

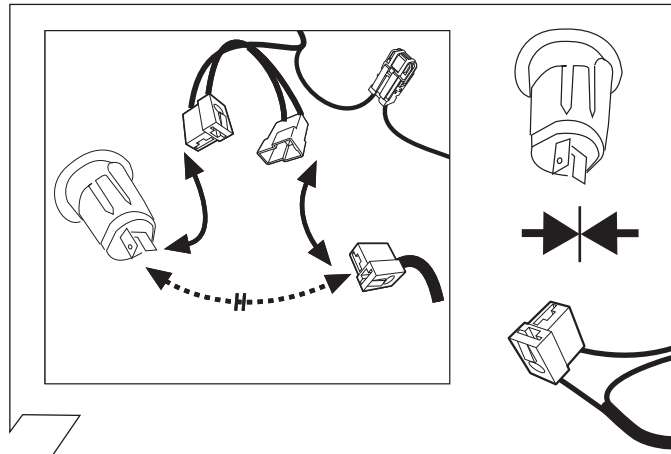

25

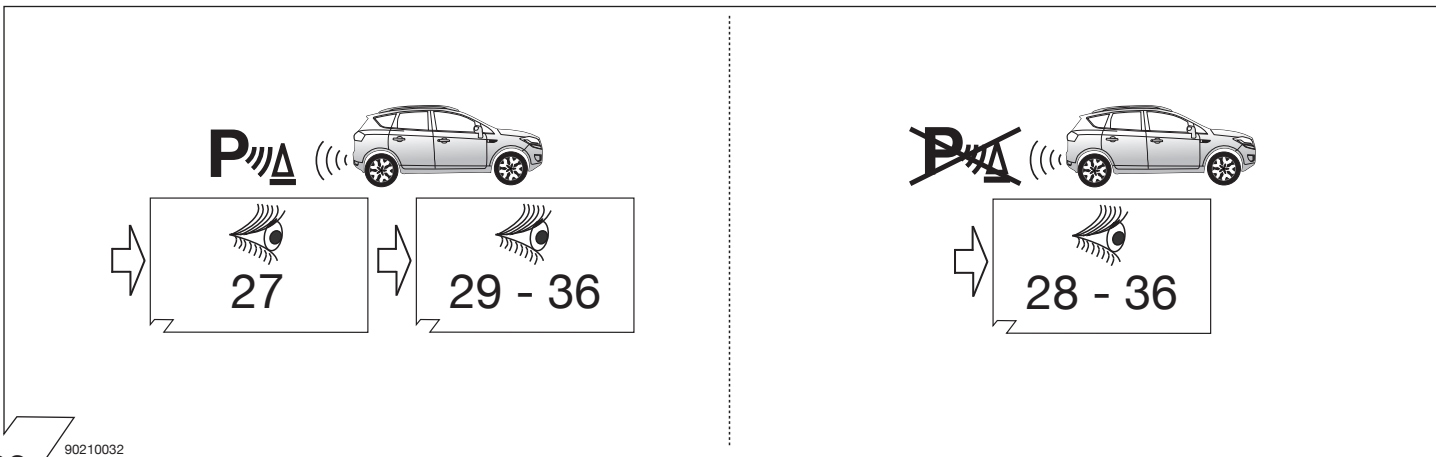

26

90210032

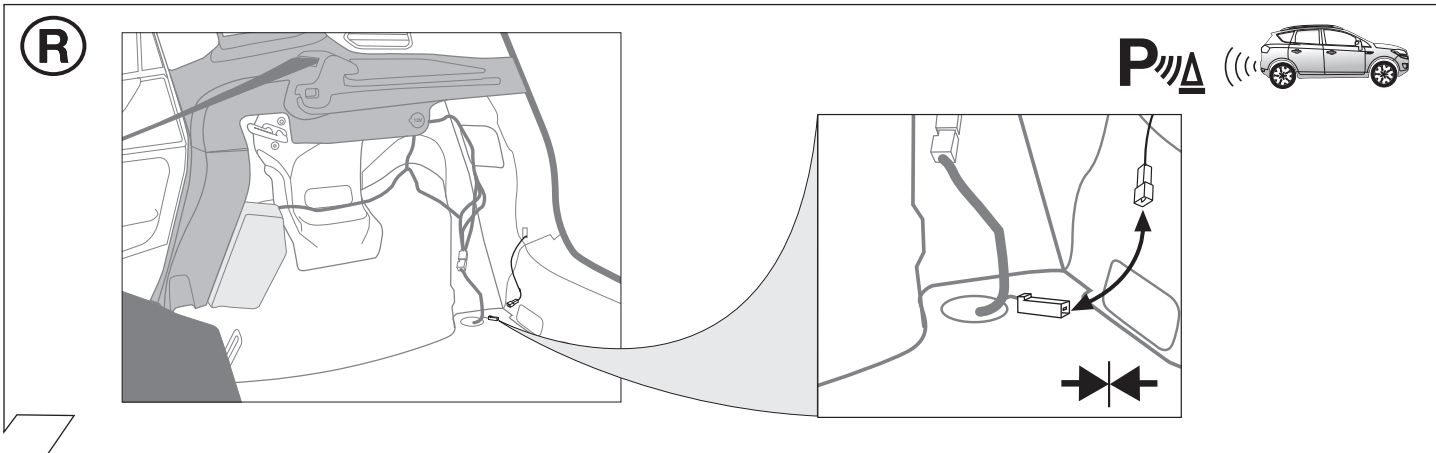

27

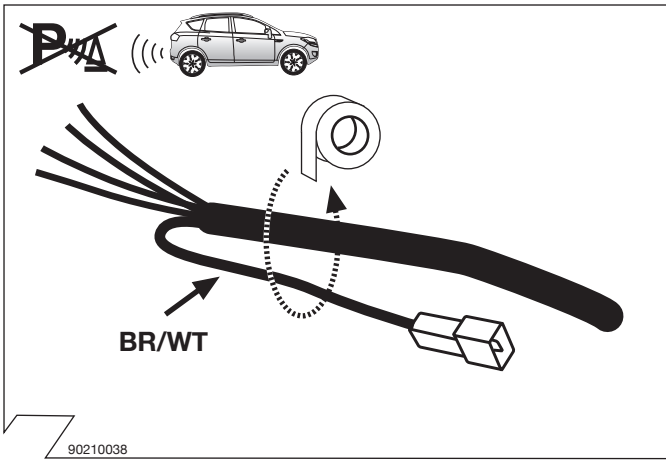

28

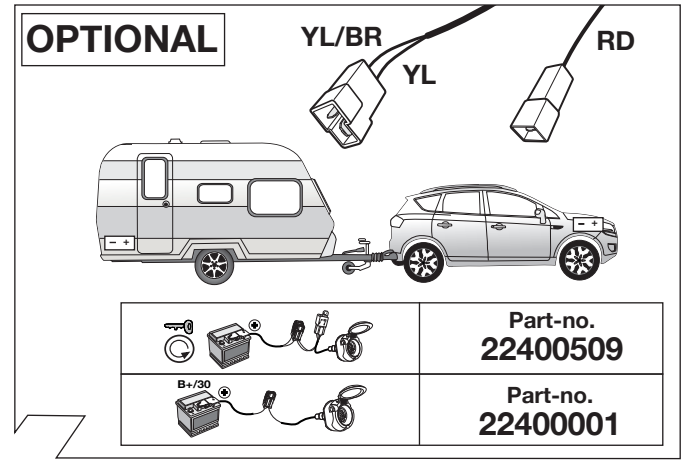

29

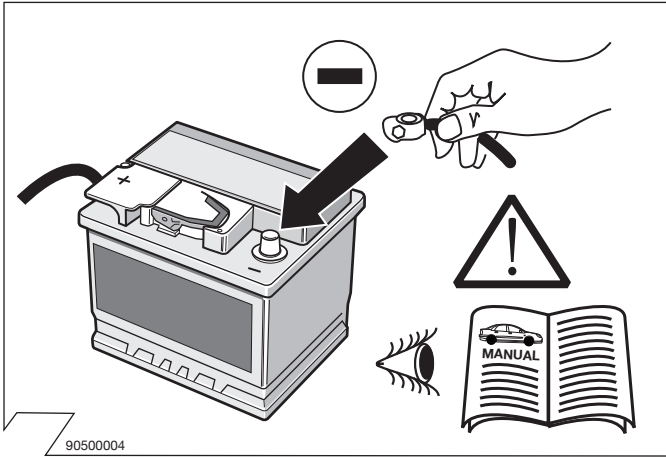

30

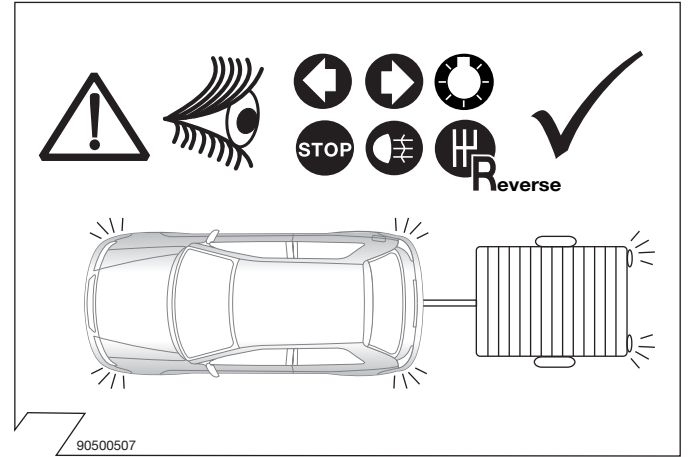

31

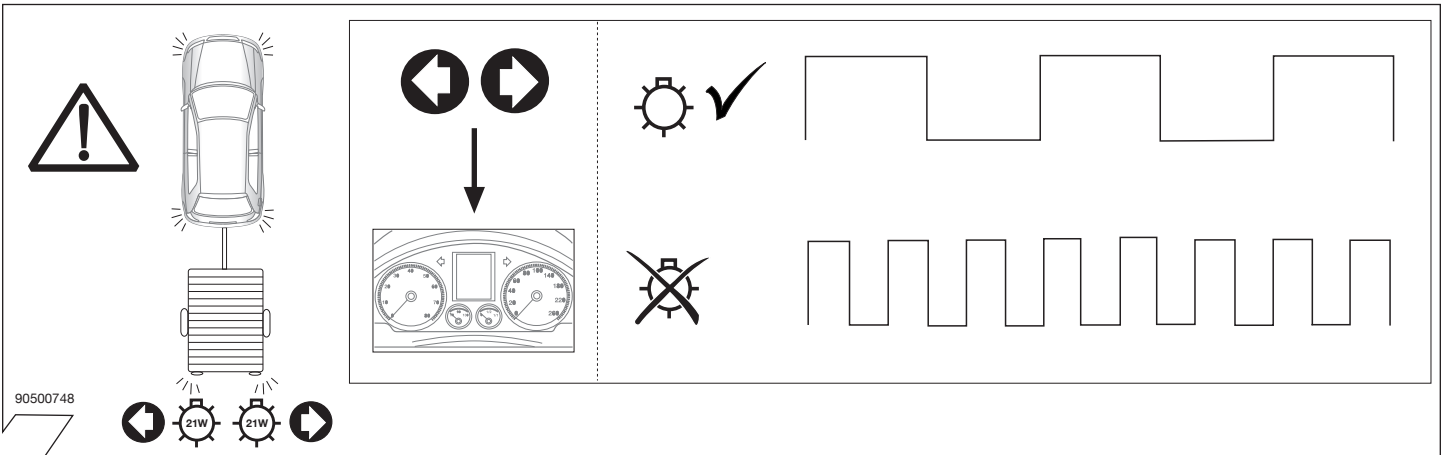

32

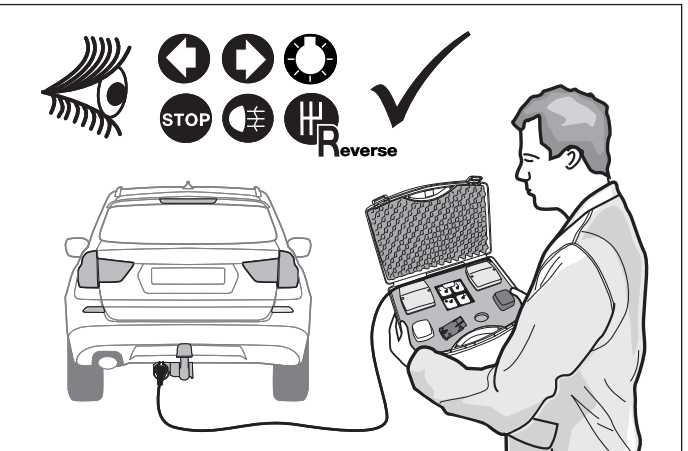

33

Optional: Adapter socket 62400003

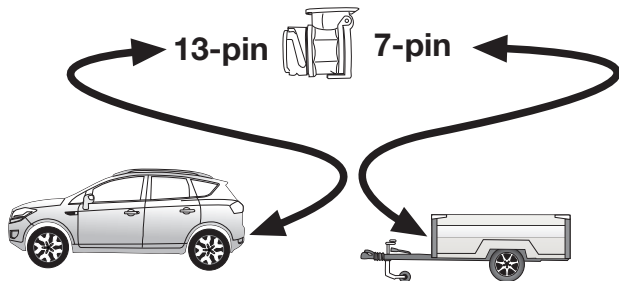

90500332



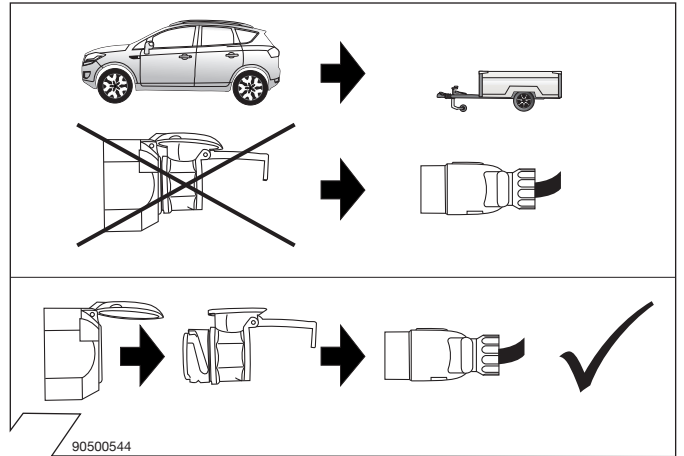



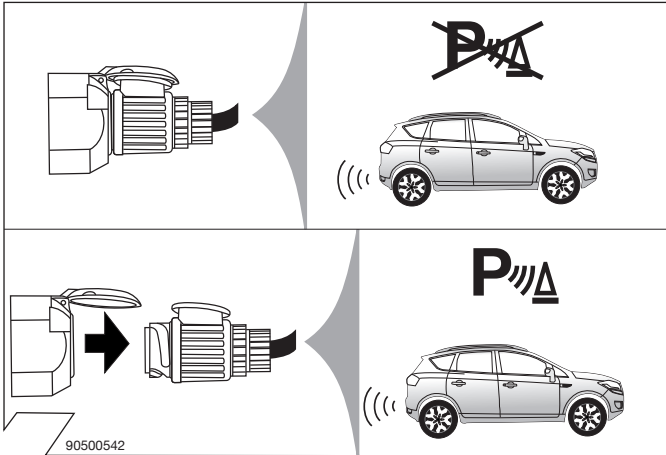

















34



35



36

ERKLÄRUNG SYMBOLE	SYMBOL EXPLANATION	EXPLICATION DES SYMBOLES	SPIEGAZIONE DEI SIMBOLI	EXPLICACIÓN DE LOS SIMBOLES	VERKLARING SYMBOLEN
(D)	(GB)	(F)	(I)	(E)	(NL)
	left (58-L) respectively right (58-R) tail light	feu arrière gauche (58-L) respectivement droite (58-R)	luce posteriore sinistra (58-L) rispettivamente destra (58-R)	plato trasero izquierdo (58-L) respectivamente derecho (58-R)	Linker (58-L) c.q. rechter (58-R) achterlicht
	stop light (54) / high mounted, third stop light (54)	3ème feu de stop (54)	luce d'arresto (54) / 3. luce d'arresto (54)	luz de freno (54) / tercera luz de freno (54)	Remlicht (54) / 3e remlicht (54)
	turn signal indicator left	feu indicateur de direction gauche	indicatore di direzione sinistra	luz indicadora de dirección de marcha izquierda	Richtingaanwijzer links
	turn signal indicator right	feu indicateur de direction droite	indicatore di direzione destra	luz indicadora de dirección de marcha derecha	Richtingaanwijzer rechts
	rear fog light(s)	feu (x) arrière (s) de brouillard	fendinebbia	luz (-ces) trasera (s) antineblia (s)	Mistachterlicht(en)
	reversing light(s)	feu (x) de marche arrière	luce (i) retromarcia	luz (-ces) de marcha atrás	Achteruitrijlicht(en)
	Permanent power supply / 13pin socket, chamber 9	courant continué / prise de courant à 13 pôles, compartiment 9	alimentazione continua / presa 13 poli, camera 9	positivo continuo / caja de anclure a 13 polos, cámara 9	Continuustroom / stekkerdoos 13P kamer 9
	charging wire for trailer battery / 13pin socket, chamber 10	cable de charge / prise de courant à 13 pôles, compartiment 10	cavo di carica / presa 13 poli, camera 10	cable de carga / caja de anclure a 13 polos, cámara 10	Laaddraad / stekkerdoos 13P kamer 10
	trailer recognition	détection de la fonction "remorque"	rimorchio / riconoscimento rimorchio	remolque / detección del remolque	Aanhanger / aanhangeridentificatie
	Permanent current power supply	courant continue / alimentation électrique permanente	corrente / alimentazione continua	positivo continuo / alimentación de corriente permanente	Continuustroom / permanente stroomvoorziening
	Ground or Earth (31)	masse (31)	massa (31)	masa (31)	Massa (31)
	ground connection battery terminal lug	borne "moins" de la batterie	connessione negativa della batteria	conexión negativa de batería	Accupoolkiem aansluiting min
	positive connection battery terminal lug	borne "plus" de la batterie	connessione positiva della batteria	conexión positiva de batería	Accupoolkiem aansluiting plus
	fuse / fuse capacity 20 Ampère	ampérage 20 ampères	fusibile / fusibile con capacità 20 Ampère	fusible / amperaje 20 amperes	Zekering / zekeringsterkte 20 Ampère
	cigarette lighter / accessory socket	allume-cigare / prise d'accessoires	accendisigari / presa accessori	encendido de cigarillos / caja de accesorios	Sigarettenaanstekker / accessoirestekkerdoos
	loudspeaker / buzzer	haut-parleur / vibreur	autoparlante / cicalino	altavoz / señal acustica de advertencia	Luidspreker / waarschuwingszoemer
	park distance control	assistance au parking	sensori di parcheggio	ayuda para aparcar	Inparkeerhulp
	switch / source of function	interrupteur / origine de fonction	interruttore / origine funzione	interruptor / origen de función	Schakelaar / functieoorsprong
	Connect together	raccorder	connessione	conectar	Koppelen
	disconnect	séparer	sconnessione	separar	Ontkoppelen
	Look at / see further information	considérer / voir informations ultérieures	considerare / vedere ulteriori informazioni	considerar / véase las informaciones	Let op / bekijk verdere informatie
	look carefully at selected area	faire attention à la zone sélectionnée	considerare area selezionata	considerar el área seleccionada	Let op gekozen bereik
	Present / Occupied / Not present / Not occupied / not OK	disponible / occupé / OK / pas disponible / pas occupé / pas OK	presente / occupato / OK / non presente / non occupato / non OK	presente / ocupado / OK / non presente / non ocupado / non OK	Aanwezig / bezet / i.o. / Niet aanwezig / niet bezet / niet i.o.
	left	gauche	sinistra	izquierdo	Links
	right	droite	destra	derecho	Rechts
	acoustic indication	signalisation acoustique	segnalazione acustica	señalización acústica	Akoestische Signalisering
	attention / important advice	attention / indication importante	attenzione / indicazione importante	atención / indicación importante	Attentie / belangrijke instructie