



FORT GALAXY
SEAT ALHAMBRA
VOLKSWAGEN SHARAN

1995 - 2000

Cat. No. E/010

E20

E20-55R-01-1144

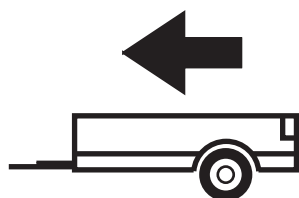

2200Kg

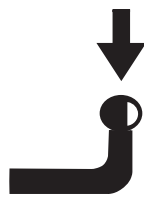

85Kg

D = 11,20kN

D (kN) =



MAX kg x MAX kg

x 0,00981



MAX kg + MAX kg

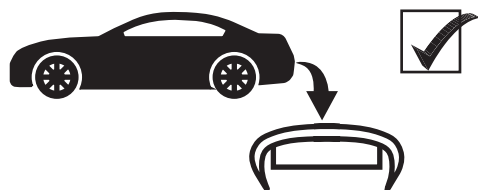

IMIOLA HAK-POL

96-111 KOWIESY, CHOJNATA 23A, POLAND

tel. +48 46 831 73 31, fax +48 831 74 29

e-mail: office@imiola.pl, www.imiola.pl

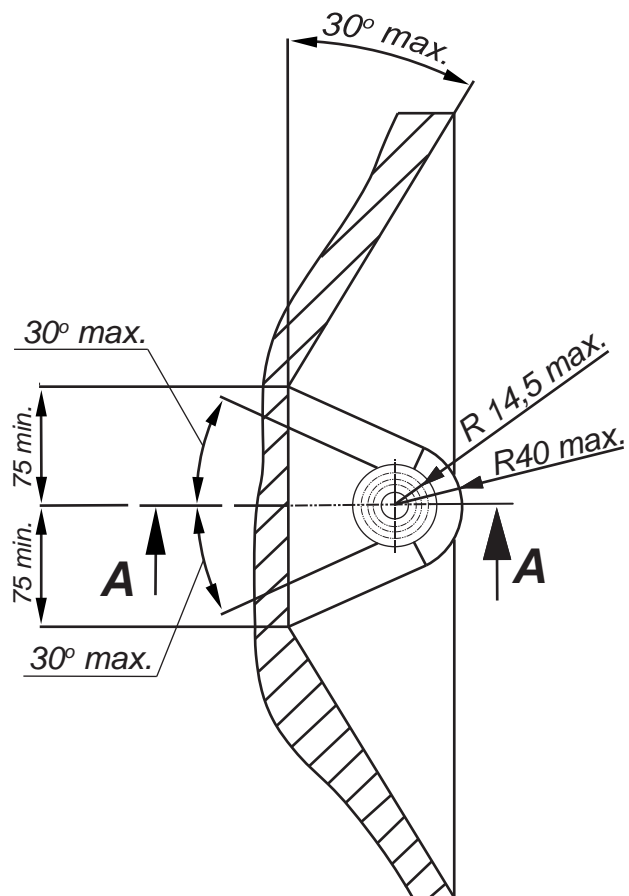

PRZEKRÓJ A-A

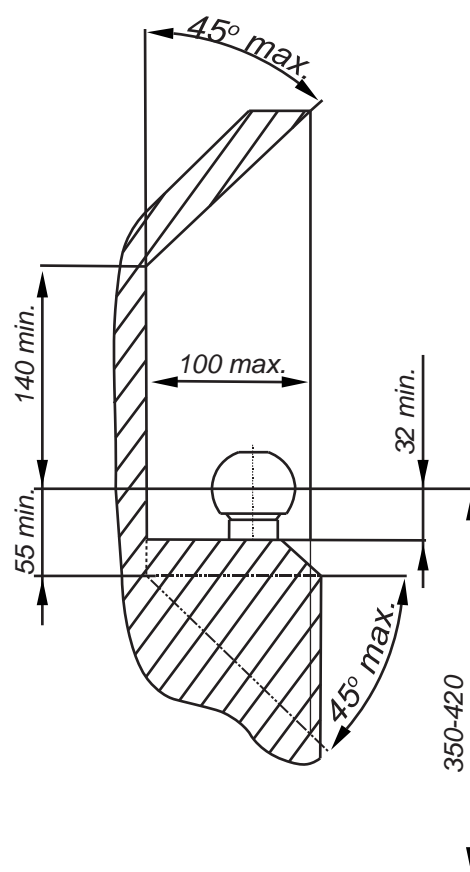

PL Należy zagwarantować przestrzeń swobodną według załącznika VII, rysunek 25a/b Regulaminu EKG ONZ 55.01 przy dopuszczalnym ciężarze całkowitym pojazdu.

F L'espace libre doit être garanti conformément à l'annexe VII, illustration de la réglementation 55.01 CE pour un poids total en charge autorisé du véhicule.





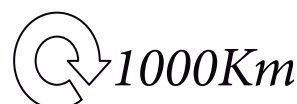

GB The clearance specified in appendix VII, diagram 25a/b of Regulation No. 55.01 UN EU must be guaranteed at laden weight of the vehicle.

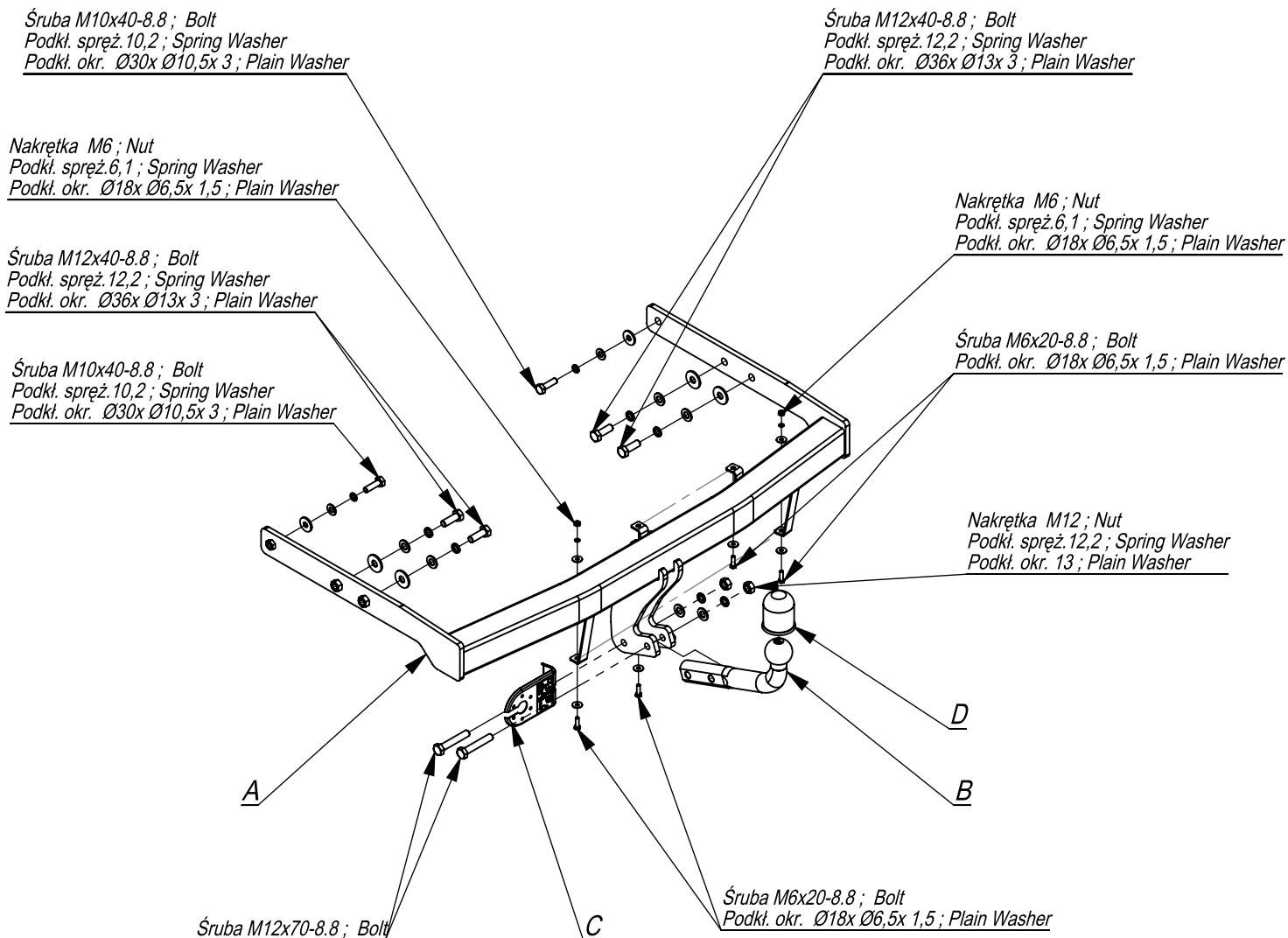
D Der Freiraum nach Anhang VII, Abbildung 25a/b der Vorschriften 55.01 EG ist zu gew 25a/b abzuhalten bei zulässigem Gesamtgewicht des Fahrzeuges.

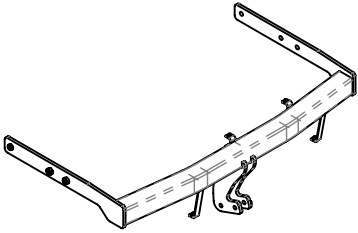
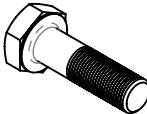
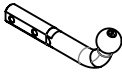
Moment skracający dla śrub i nakrętek (8.8) Torque settings for nuts and bolts (8.8)	
M8	25Nm
M10	55Nm
M12	85Nm
M14	135Nm
M16	195Nm





	A	x1		M12x70	2
				M12x40	4
				M10x40	2
				M6x20	4
	B	x1		M12	2
				M6	2
	C	x1		Ø36xØ13x3	4
				Ø30xØ10,5x3	2
				Ø18xØ6,5x1,5	6
	D	x1		13	2
				12,2	6
				10,2	2
				6,1	2

Śruba M12x40-8.8 ; Bolt
Podkl. spręż. 12,2 ; Spring Washer
Podkl. okr. Ø36x Ø13x 3 ; Plain Washer

Śruba M10x40-8.8 ; Bolt
Podkl. spręż. 10,2 ; Spring Washer
Podkl. okr. Ø30x Ø10,5x 3 ; Plain Washer

Nakrętka M6 ; Nut
Podkl. spręż. 6,1 ; Spring Washer
Podkl. okr. Ø18x Ø6,5x 1,5 ; Plain Washer

Śruba M12x40-8.8 ; Bolt
Podkl. spręż. 12,2 ; Spring Washer
Podkl. okr. Ø36x Ø13x 3 ; Plain Washer

Śruba M10x40-8.8 ; Bolt
Podkl. spręż. 10,2 ; Spring Washer
Podkl. okr. Ø30x Ø10,5x 3 ; Plain Washer

Nakrętka M6 ; Nut
Podkl. spręż. 6,1 ; Spring Washer
Podkl. okr. Ø18x Ø6,5x 1,5 ; Plain Washer

Śruba M6x20-8.8 ; Bolt
Podkl. okr. Ø18x Ø6,5x 1,5 ; Plain Washer

Nakrętka M12 ; Nut
Podkl. spręż. 12,2 ; Spring Washer
Podkl. okr. 13 ; Plain Washer

Śruba M6x20-8.8 ; Bolt
Podkl. okr. Ø18x Ø6,5x 1,5 ; Plain Washer

Śruba M12x70-8.8 ; Bolt

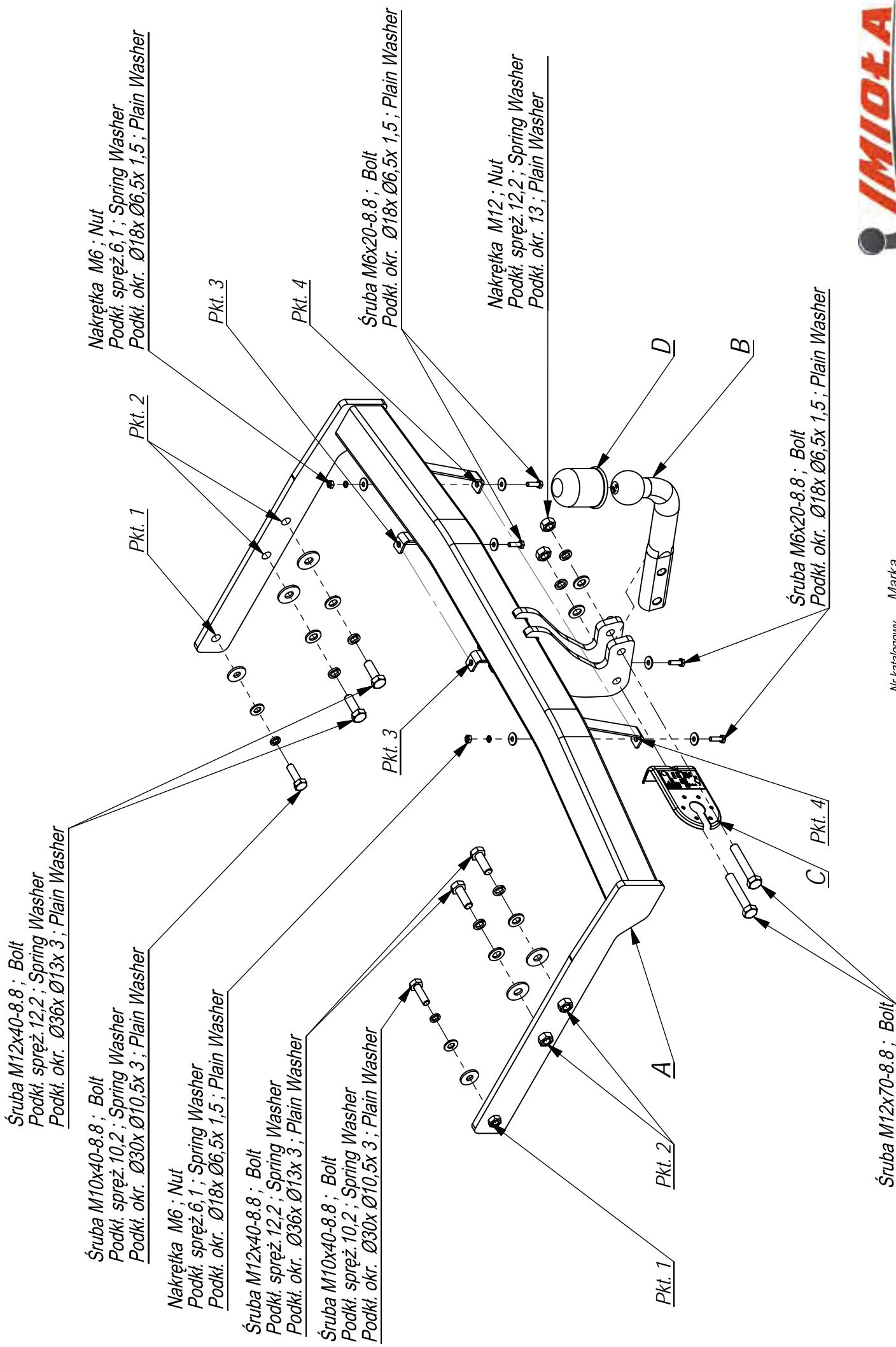

Nr katalogowy

Marka

E/010

Ford Galaxy, VW Sharan

Seat Alhambra

od 06/95-05/00

96-111 Kowiesy, Chojnata 23 A

tel. +48 46 831 73 31



- Odkręcić zderzak i zdemontować wypełnienie zderzaka (nie będzie już wykorzystane).
- Na uchwyty zaczepu A (pkt 3, 4) zamontować zderzak.
- Wsunąć hak w podłużnice i przez technologiczne otwory przykręcić śrubami M12x35 8.8 (pkt 2) oraz śrubami M10x35 8.8 (pkt 1) stosując powiększone podkładki.
- Dokręcić wszystkie śruby z momentem wg tabeli.
- Podłączyć instalację elektryczną.
- Przykręcić zderzak.
- Przykręcić kulę oraz blachę gniazda elektrycznego.

- Unscrew the bumper and disassemble his filling (it will not be used any more).
- Assemble the bumper on the handles A (point 3, 4).
- Insert the tow bar in the metal clamps and screw, through the technological holes, with bolts M12x35 8.8 (point 2) and with bolts M10x35 8.8 (point 1) using enlarge washers.
- Tighten all the bolts according to the torque setting- see the table.
- Connect the electric wires.
- Screw the bumper.
- Fix the ball and electric plate.

- Dévisser le pare-chocs et démonter le remplissage du pare-chocs (il ne sera plus utilisé).
- Monter le pare-chocs sur les manchons du crochet A (point 3).
- Insérer le crochet d'attelage dans les longerons et serrer (point 2) par les trous technologiques dans les longerons, à l'aide des boulons M12x35 8.8 et des boulons M10x35 8.8 (point 1) en utilisant les rondelles.
- Serrer tous les boulons avec un couple de serrage selon tableau.
- Raccorder le circuit électrique.
- Monter le pare-chocs.
- Visser le crochet d'attelage et socle de prise électrique.

